

 MOVING
CHAIRS COLLECTIONS

 MOVING

moving.vi.it

TheSeatingPhilosophy





TOP collection 28	OPE RAT IVE collection 178	SL IM collection 322
BUS INE SS collection 376	COM MUN ITY collection 486	Company 6 Mechanisms 512 Armrests 516 Certifications 520 Warranty 524

The
origins

The Roots Of A Big Family



The
production



Partendo come un piccolo laboratorio, Pietro Lovato ha saputo sviluppare la propria attività che da trentotto anni produce sedute professionali. La sua esperienza di imprenditore unita allo spirito giovane e fresco delle nuove generazioni conducono l'azienda con la stessa filosofia aziendale di sempre: guardare al futuro e all'innovazione partendo da una tradizione solida e robusta.

Starting as a small workshop, Pietro Lovato have been able to develop its business that from 38 years produce professional seatings.

His experience as an entrepreneur is combined with the young spirit of the company's new generation in order to pursue the company's goal and core philosophy: looking at the future and innovation, starting from a strong and solid tradition.

En partant d'un petit laboratoire, Pietro Lovato, a su développer son activité que depuis 38 ans se prend soins de la santé de ceux qui restent assis beaucoup de temps.

Son expérience d'entrepreneur unie au jeun esprit des nouvelles générations entrées dans l'entreprise, poursuit l'objectif fondamental de la philosophie de la société : regarder à la future et à l'innovation en partant d'une tradition solide et robuste.

Aus eine kleiner Werkstatt hat Pietro Lovato sein Geschäft entwickelt welches seit 38 Jahre professionelle Stühle produziert.

Seine Erfahrung als Unternehmer, zusammen mit der frische junge Geistlichkeit der neuen Generationen, führen das Unternehmen mit der gleiche Philosophie: Blick in die Zukunft und Innovationen, ausgehend von einer feste und stabile Tradition.

MOVING
Since 1980 Without Taking A Seat



The Lovato family



Pietro Lovato
Founder and
Managing Director



Claudia Lovato
Production director

aFamilyThatWorksTogether



Alessandra Lovato
Sales Manager



Arianna Lovato
Purchasing Manager

Oggi, ieri e domani, da sempre il punto di riferimento per ogni persona in azienda. Una famiglia.

Today, yesterday and tomorrow, always a reference point for any person of the company. A family.

Aujourd'hui, hier et demain, depuis toujours point de référence pour chaque personne dans l'entreprise. Une famille.

Heute, gestern und morgen, war schon immer die Referenz für jeden im Unternehmen. Eine Familie.

Pietro e Claudia Lovato, con carisma e intraprendenza, hanno costruito in 38 anni di attività un'azienda, una squadra, una famiglia, un nome figlio della loro caratteristica principale: il movimento.

Pietro and Claudia Lovato, with charisma and initiative, have been creating throughout 38 years of activity a company, a team, a family, a name based on its main characteristic: moving.

Pietro et Claudia Lovato, avec du charisme et de l'ingéniosité ont construit en 38 ans d'activité une entreprise, une équipe, une famille, un nom synonyme de sa caractéristique principale : le mouvement.

Pietro u. Claudia Lovato haben In 38 Jahre Berufserfahrung, vor Allem mit Charisma und Unternehmungsggeist , ein Team, eine Familie, einen Name aufgebaut; dieser Name stammt aus einem Hauptpunkt: und zwar, die Bewegung

Beginning From The Raw Materials

Con il passare del tempo l'idea generatrice del progetto cresce insieme agli uomini e alle loro strategie, trasformando il piccolo laboratorio in una realtà aziendale strutturata.

With the passing of time, the idea that gave birth at the project grew together with our people and their strategies, turning the small workshop in a structured company reality.

Avec le temps qui passe, l'idée qui a donné naissance au projet a grandi ensemble aux gens et à leur stratégies, en transformant le petit atelier dans une réalité d'entreprise structurée.

Im Laufe der Zeit die Idee, die bei der Geburt das Projekt wuchs zusammen mit unseren Leuten und ihren Strategien, drehen die kleinen Workshop in einem strukturierten Unternehmensrealität.

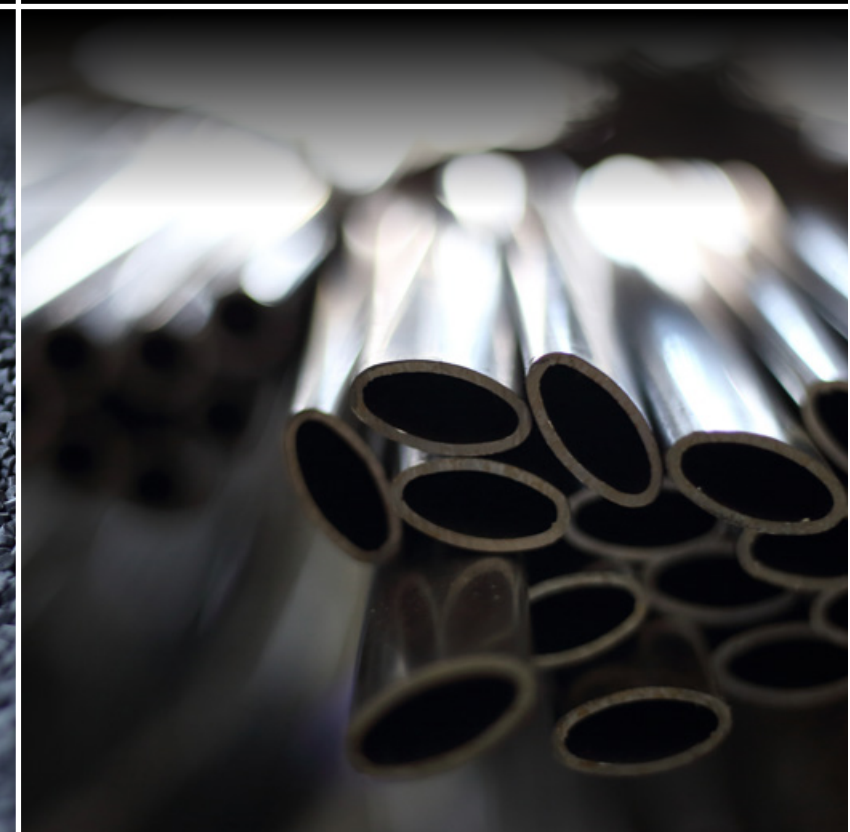
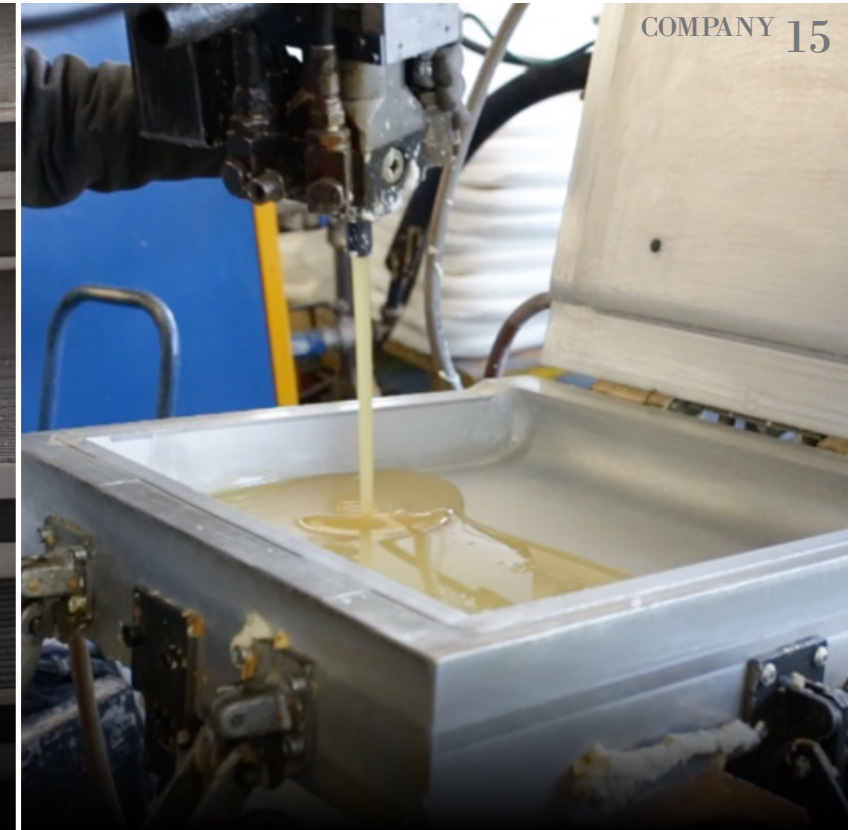

The Craftmanship experience





Paying Attention To Every Details

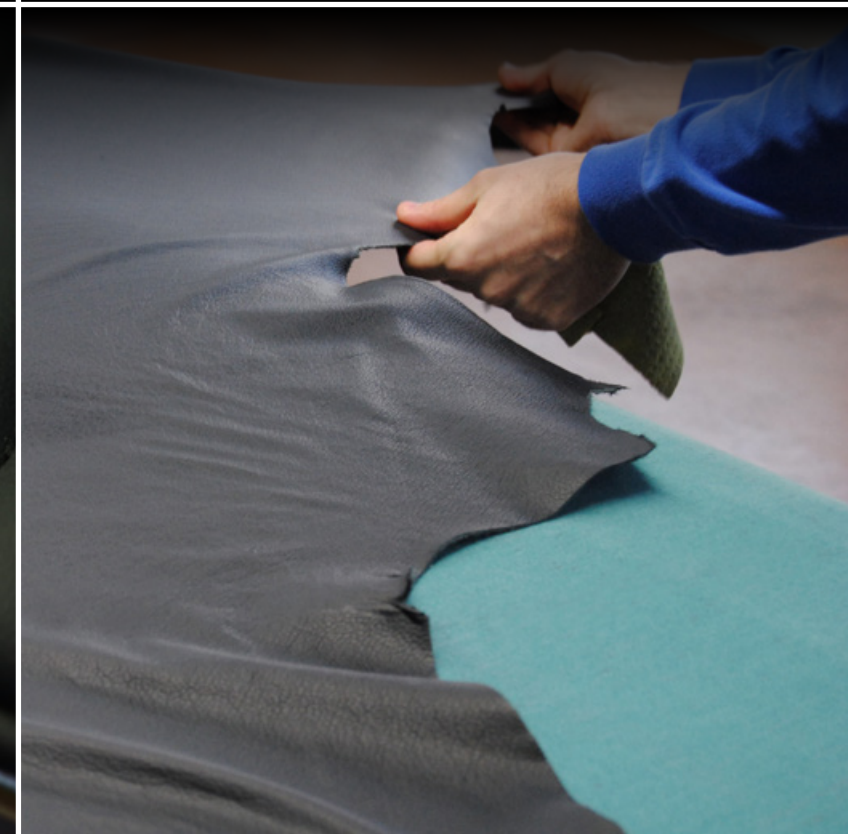
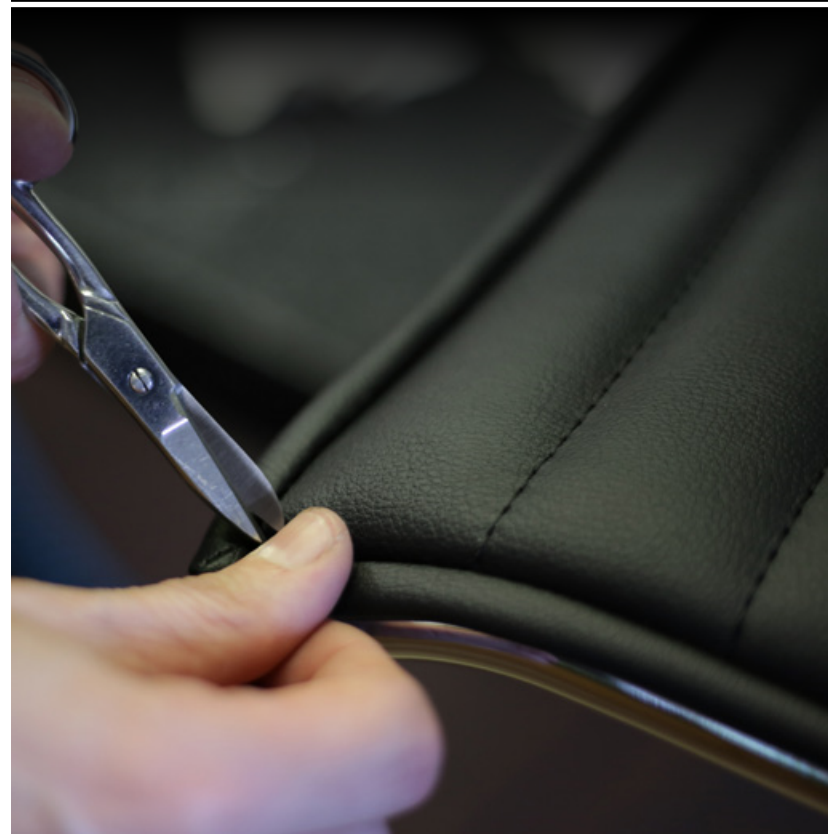

Self-Control Attitude

Tutte le nostre sedute sono 100% made in Moving, vengono progettate e realizzate completamente all'interno dell'azienda. L'idea, la ricerca, il progetto e poi la scelta dei materiali, la realizzazione, il controllo della qualità. Dalla realizzazione dello stampo, all'assemblaggio finale della seduta e collaudo.

All the chairs are 100% made in Moving: they are designed and realized completely in-house.

Idea, research, project; and then selection of raw materials, realization and quality control. from the production of the mould to the final assembling of the chair and its test.

Tous nos produits sont 100% "Made in Moving" et ils sont conçus et réalisés entièrement chez nous.

L'idée, la recherche, le projet, le choix des matériaux, la réalisation, le contrôle de qualité. De la réalisation du moule à l'assemblage et test final du produit.

Alle Stühle sind 100% "made in Moving". Sie werden entworfen und vollständig im eigenen Werk produziert.

Von der Idee her, bis zur Forschung, Projektierung, Auswahl vom Material, sowie die Herstellung von unseren Werkzeuge, Endmontage und Qualitätskontrolle.

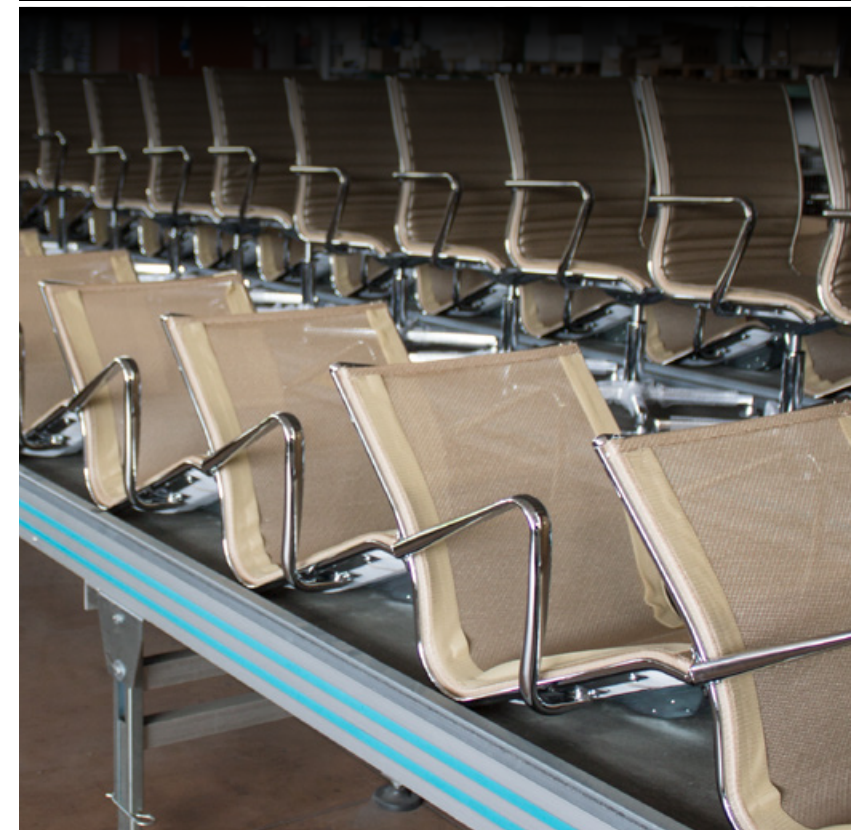
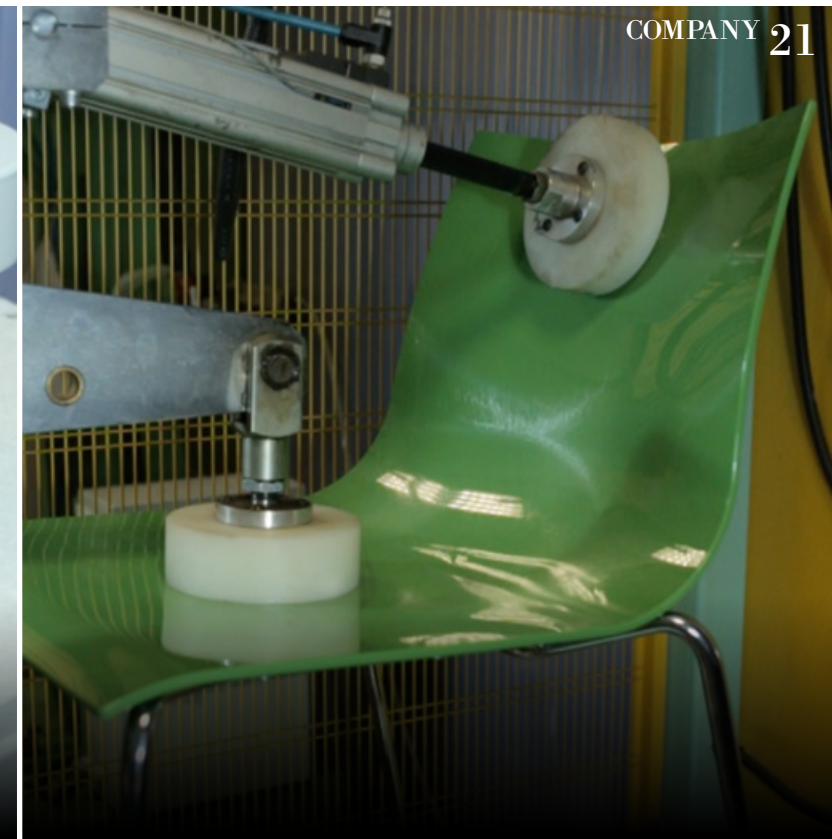

MOVING

CHAIRS COLLECTIONS

Research
and
innovation



Una postura dinamica.

Il sedile e lo schienale assecondano i movimenti dell'operatore garantendo un appropriato sostegno del corpo durante ogni attività, mantenendo la posizione più appropriata alla mansione.



A dynamic posture. The seat and the back follow the movements of the user, ensuring proper support of the body during each activity, keeping the position more appropriate to the job.



Une posture dynamique. L'assise et le dossier suivent les mouvements de l'utilisateur en garantissant un soutien approprié pendant toute activité et une position adéquate au travail.



Dynamische Haltung. Der Sitz und die Rückenlehne folgen die Bewegungen des Benutzers und Gewährleisten eine angemessene Körperunterstützung während jede Aktivität und die Aufrechterhaltung der geeigneten Position für die geleistete Arbeit.

Un nome che riunisce oggetti, storie, esperienze, in pieno stile made in **Italy**.

A brand collecting objects,
stories and experiences, in
a full made in Italy style.

Un nom qui réunit des
objets, des histoires, des
expériences, en plein style
Made in Italy.

Eine Marke, die Objekte
sammelt, Geschichten und
Erfahrungen, in ein MADE
IN ITALY Stil.

The
family
Brands

Lovato[®]
FACTORIES

*"Like a seed that grow, the original idea evolves
together with persons and their strategies."*

Pietro Lovato
LUXURY CHAIRS

 **MOVING**
CHAIRS COLLECTIONS

 **DIMUSA**
CHAIRS COLLECTIONS

 **Giola**
CHAIRS COLLECTIONS



BALSAMERIA CASA LOVATO

The Showroom

Trissino [VI] Italy





Dresschair
30



Alia
40

AliaC
56

AliaTop
68

Alia/C/Top
76

AliaLounge
84

Viva
92

Viva
102

Forma
106

Forma
118



AttivaC
122

Crono
140

Giada
154

Aurelia
164

Aurelia
174

Dresschair

design: AZ Creations & Water Hösel

DRESSCHAIR è una famiglia di sedute tecnologiche direzionali e semi-direzionali. Le finiture cromate lucide e il comodo sedile fanno di DRESSCHAIR una sedia da ufficio confortevole dal design molto raffinato ed elegante adatta a persone particolarmente esigenti. È disponibile con lo schienale in 2 altezze.

DRESSCHAIR is a family of technological executive and semi-directional chairs. The chromed finishing and the comfortable seat make DRESSCHAIR a comfortable office chair with a very refined and elegant design suitable for particularly demanding people. It is available in two backrest heights.

DRESSCHAIR est une famille de fauteuils de direction et semi-direction technologiques. Les finitions chromées brillantes et l'assise très confortable font de DRESSCHAIR un siège de bureau accueillant, caractérisé par un design raffiné et élégant, apte à des personnes très exigeantes. DRESSCHAIR est disponible en 2 hauteurs de dossier.

DRESSCHAIR A ist eine technologische Stuhlfamilie für Direktionsbereiche und Geschäftsleitungen. Die verchromte und glänzende Feinbearbeitungen und der bequeme Sitz machen DRESSCHAIR einen komfortablen Drehstuhl mit raffinierten Design und Eleganz geeignet für sehr anspruchsvolle Menschen. Die Rückenlehne ist in zwei verschiedenen Höhen verfügbar.

Dresschair



Dresschair

Girevole, imbottita a fasce e liscia, rete, molle sedile. Schienale medio o alto.

Swivel, upholstered with or without stripes, mesh, packed springs. Medium or high backrest.

Pivotant, rembourré en bandes et simple, résille, ressort assise. Moyen ou haut dossier.

Drehbar, gepolstert mit oder ohne Steppungen, Netz, Federkern im Sitz. Mittlere oder hohe Rückenlehne.



versions

Dresschair
High



Dresschair
Medium





Life Space interiors /EAU



Dresschair

Stripes & Simple

Dresschair

Mesh



Dresschair

Mesh

Dresschair



backrest
High

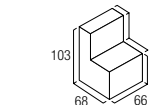
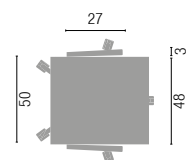
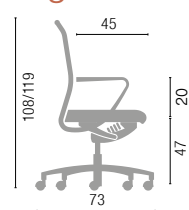

UNIT/PACK 1 - Kg 26,49 - m³ 0,4

backrest
Medium

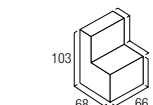
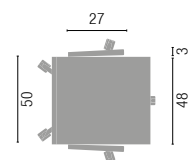
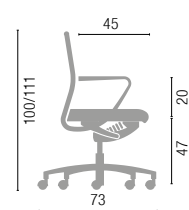

UNIT/PACK 1 - Kg 26,39 - m³ 0,4

technical data

mechanism

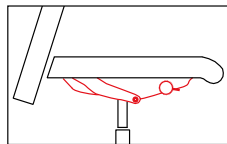

Meccanismo SynchroPlus+ con traslazione sedile
SynchroPlus+ mechanism with sliding seat device
Mécanisme SynchroPlus+ avec translation d'assise
SynchroPlus+ Mechanik mit Schiebesitz

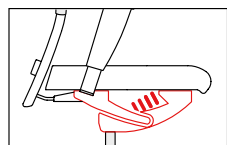

Meccanismo SynchroTeK nero con traslazione sedile, inclinazione negativa
Black SynchroTeK mechanism with sliding seat device, negative angle adj
Mécanisme SynchroTeK noir avec translation et réglage négatif d'assise
Schwarze SynchroTeK Mechanik mit Schiebe- und Sitzneigung

options

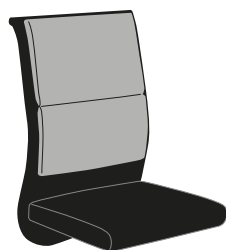

XC014 - high

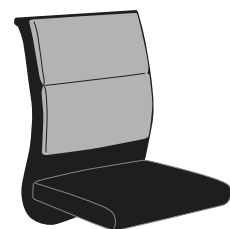

XC016 - medium

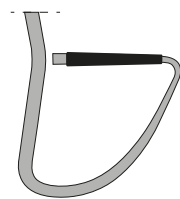

XH003 - uph. pad



lumbar support
XR001 - beige
XR006 - black

base



Base 5 razze in alluminio lucida
5-spoke polished aluminium base
Pièr. 5 branche alu poli
5-Stern Alu poliertes Fußkreuz



Base 5 razze in ferro cromata
5-spoke chromed iron base
Pièr. 5 branche en métal chromé
5-Stern verchromtes Eisen Fußkreuz

castors



welness and comfort

1. SCHIENALE:

Tube sagomato d'acciaio, Ø 25mm, finitura cromata (15µm) rivestito in rete o imbottito con spugna e rivestito in tessuto

2. SEDILE:

Polipropilene imbottito con spugna schiumata a freddo, rivestita in tessuto

3. MECCANISMO:

- SynchroPlus+, comando elevazione a gas, regolazione tensione schienale, inclinazione 20°sch. 8°sed. in 5 posizioni con antishock, traslazione sed. 6cm in 5 posizioni
- SynchroTeK cromato o nero, comando elevazione a gas, regolazione tensione schienale: inclinazione 26°sch. 10.5°sed. in 5 posizioni con antishock, inclinazione negativa sed. 4,5°. traslazione sed. 6cm in 5 posizioni

4. GAS:

Regolabile in altezza, rotazione, finitura cromata, molleggio

5. BASE:

- 5 razze in alluminio, Ø 710mm, finitura lucida
- 5 razze in ferro, Ø 710mm, finitura cromata (15µm)

6. RUOTE:

- Ø 65mm, gommata o autofrenanti e gommata, finitura nera
- Ø 50mm, autofrenanti o autofrenanti e gommata, finitura cromata

1. BACKREST:

Ø25mm shaped steel tube backrest, chromed finish (15µm), mesh upholstered or foam padded and fabric upholstery

2. SEAT:

Polypropylene seat, cold injected foam padded, fabric upholstery

3. MECHANISM:

- SynchroPlus+, gas lift height adj. Backrest tension adj. backrest inclination 20° in 5 locking position with antishock, seat inclination 8°. Sliding seat device 6cm in 5 positions
- Chromed or black SynchroTeK, gas lift height adj. Backrest tension adj. Backrest inclination: 26° in 5 positions with antishock; Seat inclination: 10.5°. Negative seat inclination: 4.5°. Sliding seat device 6cm in 5 positions

4. GAS LIFT:

Height adjustable, swivel, chromed finish, shock absorber springs

5. BASE:

- Polished aluminium 5 spoke base, Ø 710 mm
- Iron 5 spoke base, Ø 710 mm chromed finish (15µm)

6. CASTORS:

- Ø 65mm self-braking castors, or soft self-bracking. Black finish
- Ø 50 mm self-braking castors, or soft self-bracking. Chromed finish



A Pressione sullo schienale di spalle e scapole
Shoulders and scapulas pressure on backrest
Pression des épaules et omoplates sur le dossier
Druck von der Schulter und Schulterblatt auf der Rückenlehne

B Pressione dell'area sacrale su supporto lombare
Sacrum pressure on lumbar support

C Pressione di bacino e cosce sul sedile
Hip and thigh pressure on seat
Pression des cuisses et du bassin sur l'assise
Druck im Becken und Oberschenkel auf dem Sitz

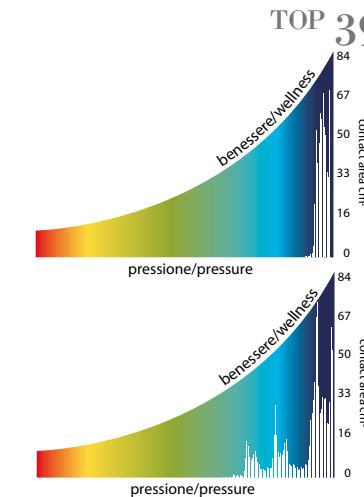

Alia

design: Ambostudio

ALIA trova il suo spazio nell'ufficio direzionale; la linea pulita e minimalista nonché l'idea di solidità unita alla leggerezza che trasmette, si addice ad un ambiente moderno, tecnologico e professionale. È dotata di meccanica oscillante con punto di rotazione avanzato. I braccioli in acciaio cromato sono disponibili come optional, e donano ad Alia un profilo ancora più sofisticato. Cura nel design, attenzione ai dettagli fanno di Alia una seduta unica per l'ufficio di prestigio.

ALIA find his place in the Executive offices; The pure and minimalist lines, the sturdiness combined with lightness it conveys, make it suitable for modern, technological and professional spaces. It is equipped with a tilting mechanism; the optional chromed armrests, provide to Alia an even more sophisticated profile. The attention to Design and details make Alia a unique chair for prestige offices.

ALIA trouve sa place dans les bureaux de direction; les lignes essentielles et minimalistes ainsi que l'idée de force combinée avec la légèreté qu'elle transmet, font de Alia un fauteuil apte à des espaces modernes, technologiques et professionnels. Elle est équipée d'un mécanisme basculant décalé. Les accoudoirs, qui sont disponibles en acier chromé comme option, donnent à Alia un profil encore plus sophistiqué. Une conception soignée et de l'attention aux détails font de Alia un siège unique pour le bureau de prestige.

ALIA findet sein Platz im Direktionsbüro; die saubere und minimalistische Linie, sowie die kombinierte Idee von Solidität und Leichtigkeit, eignet sich für moderne, technologische und professionellen Bereich. Ausgestattet mit Wipp Mechanik und vorgegeschobenen Drehpunkt. Die verchromten Stahl Armlehnen sind auf Wunsch erhältlich und geben der Alia ein anspruchsvolles Profil. Das sorgfältige Design mit Liebe zum den Details, machen aus Alia einen einzigartigen Stuhl für hochwertige Büros.

Alia



Alia

Girevole, traverso standard.
Schienale medio o alto.

Swivel, standard bar.
Medium or high backrest.

Pivotant, traverse standard.
Moyen ou haut dossier.

Drehebar, Querstange standard.
Mittlere oder hohe Rückenlehne.



versions

Alia
High



Alia
Medium



Alia

High



Alia

High



Alia

High



Alia

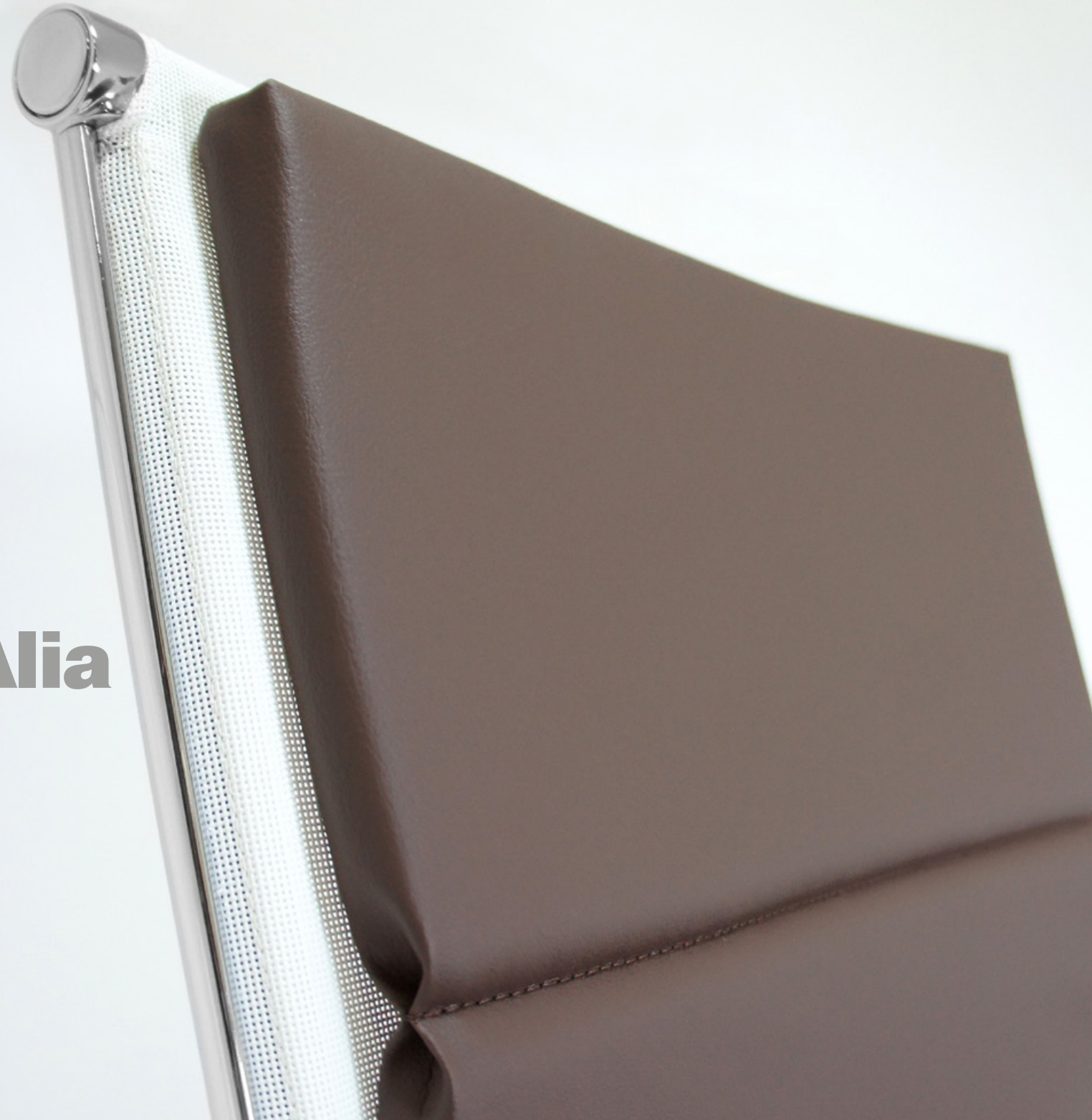

Alia
Medium



Alia
Medium & High



Alia
High



Alia



technical data

mechanism

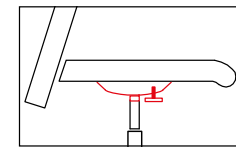

Piastra
Seat plate
Platine
Sitzplatte

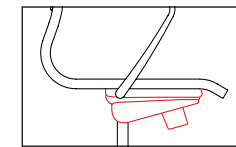

Meccanismo oscillante
Tilting mechanism
Mécanisme basculant
Wippmechanik

base



Base 4 razze in alluminio lucida
Polished aluminium 4 spoke base
Piètement 4 branches alu poli
Alu poliertes 4-Stern Fußkreuz



Base 4 razze in ferro cromata
4-spoke chromed iron base
Pièt. 4 branches en métal chromé
4-Stern verchromtes Eisen Fußkreuz



Base 5 razze in alluminio lucida
5-spoke polished aluminium base
Pièt. 5 branches alu poli
5-Stern Alu poliertes Fußkreuz

base



Base 5 razze in ferro cromata
5-spoke chromed iron base
Pièt. 5 branches en métal chromé
5-Stern verchromtes Eisen Fußkreuz

castors/feet

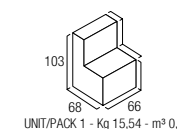
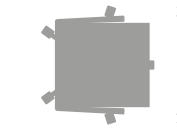
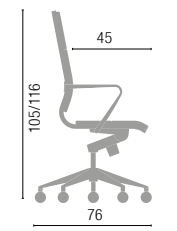
backrest
High

UNIT/PACK 1 - Kg 15,54 - m³ 0,4

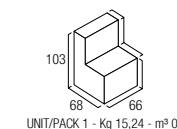
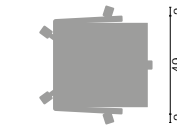
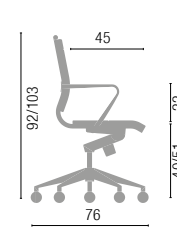
backrest
Medium

UNIT/PACK 1 - Kg 15,24 - m³ 0,4

stool

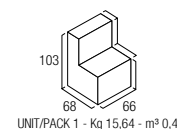
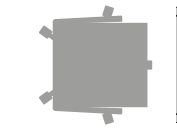
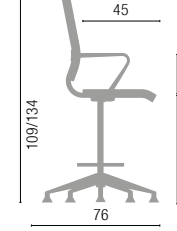

UNIT/PACK 1 - Kg 15,64 - m³ 0,4

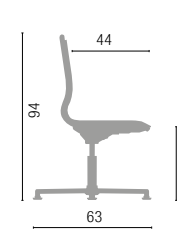
retour
Cylinder

UNIT/PACK 1 - Kg 14,84 - m³ 0,4



Alia

wellness and comfort

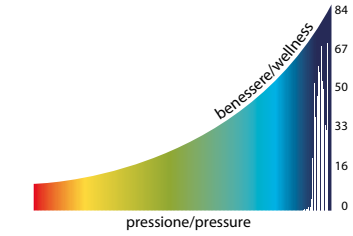

A Pressione sullo schienale di spalle e scapole
Shoulders and scapulas pressure on backrest
Pression des épaules et omoplates sur le dossier
Druck von der Schulter und Schulterblatt auf der Rückenlehne

B Pressione dell'area sacrale su supporto lombare
Sacrum pressure on lumbar support

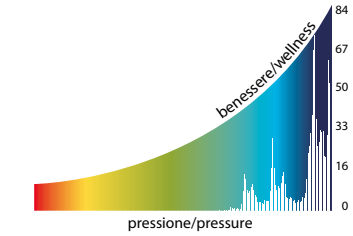

C Pressione di bacino e cosce sul sedile
Hip and thigh pressure on seat
Pression des cuisses et du bassin sur l'assise
Druck im Becken und Oberschenkel auf dem Sitz

1. SCHIENALE:

Monoscocca in tubo sagomato d'acciaio, Ø 25mm, finitura cromata (15µm), rete portante a vista

2. MECCANISMO:

- Oscillante nero, comando elevazione a gas, regolazione tensione schienale, inclinazione 18° scocca in 5 posizioni con antishock
- Comando elevazione a gas, finitura nera

3. GAS:

- Regolabile in altezza, rotazione, finitura cromata, molleggio
- Regolabile in altezza, rotazione, finitura cromata
- Altezza fissa, ritorno automatico, finitura cromata
- Regolabile in altezza, rotazione, finitura cromata, sgabello

4. BASE:

- Base 5 razze in alluminio, Ø 710mm, finitura lucida
- Base 5 razze in ferro, Ø 710mm, finitura cromata (15µm)
- Base 4 razze in ferro, Ø 720mm, finitura cromata (15µm)
- Base 4 razze in alluminio, Ø 630mm, finitura lucida

5. RUOTE/PIEDINI:

- Ø 65mm, gommato o autofrenanti e gommato, finitura nera.
- Ruote Ø 50mm, autofrenanti o autofrenanti e gommato, finitura cromata
- Piedini in polimero termoplastico, h. 68mm, finitura cromata (15µm)
- Piedini in polimero termoplastico, h. 25mm, finitura cromata (15µm)
- Piedini in polimero termoplastico, h. 40mm, finitura cromata (15µm)

6. BRACCIOLI:

Bracciolo fisso in tubo tondo d'acciaio, Ø 25mm, finitura cromata (15µm) (rivestito in tessuto)

1. BACKREST:

Shaped steel tube monocoque, Ø 25mm, chromed finish (15µm), visible load bearing Mesh

2. MECHANISM:

- Black, tilting, gas lift height adj., backrest tension adj. 18° grade with 5 locking position, and antishock
- Height adjustable, Black finish

3. GAS LIFT:

- Height adjustable, swivel, chromed finish, shock absorber springs
- Height adjustable, swivel, chromed finish
- Not height adjustable, memory return cylinder, chromed finish
- Stool version height adjustable, swivel, chromed finish

4. BASE:

- Polished aluminium 5 spoke base, Ø 710 mm
- Iron 5 spoke base, Ø 710 mm chromed finish (15µm)
- Iron 4 spoke base, Ø 720 mm chromed finish (15µm)
- Polished aluminium 4 spoke base, Ø 630 mm

5. CASTORS/FEET:

- Ø 65mm self-braking castors, or soft self-braking, Black finish
- Ø 50 mm self-braking castors, or soft self-braking, Chromed finish
- h. 68mm Thermoplastic polimer gliders chromed finish (15µm)
- h. 25mm Thermoplastic polimer gliders chromed finish (15µm)
- h. 40mm Thermoplastic polimer gliders, chromed finish (15µm)

6. ARMREST:

Fixed armrest, round steel tube Ø 25mm, chromed finish (15µm), upholstered

1. DOSSIER:

Monocoque en tube d'acier Ø 25mm, finition chromée (15µm). Réseille autoportante à vue

2. MECANISME:

- Basculant noir, réglage en hauteur, réglage de tension, inclinaison coque 18° en 5 positions avec système antichoc
- Réglable en hauteur, finition noir

3. VERIN A GAZ:

- Réglable en hauteur, pivotant, finition chromé, amortisseur
- Réglable en hauteur, pivotant, finition chromé
- Hauteur fixe, retour automatique, finition chromé
- Réglable en hauteur, pivotant, finition chromé, tabouret

4. PIÈTEMENT:

- Piètement 5 branches alu poli, Ø 710mm
- Piètement 5 branches en métal, Ø 710mm, finition chromé (15µm)
- Piètement 4 branches en métal, Ø 720mm, finition chromé (15µm)
- Piètement 4 branches alu poli, Ø 630mm

5. ROULETTES/PATINS:

- Roulettes Ø 65mm, gommées ou autofreinantes et gommées, finition noir
- Roulettes Ø 50mm, autofreinantes ou autofreinantes et gommées, finition chromé
- Patins en polymère thermoplastique, h. 68mm, finition chromée (15µm)
- Patins polymère thermoplastique, h. 25mm, finition chromée (15µm)
- Patins polymère thermoplastique, h. 40mm, finition chromée (15µm)

6. ACCUDOIR:

Accoudoir fixe en tube rond d'acier, Ø 25mm, finition chromé (15µm) (tapissé)

1. RÜCKENLEHNE:

Geformtes Stahlrohr Gestell, Ø 25mm, verchromt (15µm) sichtbares tragendes Netz

2. MECHANIK:

- Schwarze Wippmechanik, Gaslift Höhenverstellung, Rückenlehne mit Spannungsregler, 18°Schaleneigung mit 5-stufige Einstellung mit Antishock
- Schwarze Sitzhöhenverstellung

3. GASFEDER:

- Sitzhöhenverstellung, drehbar, verchromt, mit Stoßdämpfende Feder
- Sitzhöhenverstellung, drehbar, verchromt
- Rückholmechanik ohne Sitzhöhenverstellung, verchromt
- Hocker Sitzhöhenverstellung, drehbar, verchromt

4. GESTELL:

- 5-Stern Alu poliertes Fußkreuz, Ø 710 mm
- 5-Stern Eisen Fußkreuz, Ø 710mm verchromt (15µm)
- 4-Stern Eisen Fußkreuz, Ø 720mm verchromt (15µm)
- 4-Stern Alu poliertes Fußkreuz, Ø 630 mm

5. ROLLEN/GLEITER:

- Ø 65 mm gebremste, oder weiche gebremste Rollen, schwarz
- Ø 50 mm gebremste, oder weiche gebremste Rollen, verchromt
- Thermoplastische Polymergleiter, H. 68mm, verchromt (15 µm)
- Thermoplastische Polymergleiter, H. 25mm, verchromt (15 µm)
- Thermoplastische Polymergleiter, H. 40mm, verchromt (15 µm)

6. ARMLEHNEN

Feste Armlehne aus Stahlrohr, Ø 25 mm, verchromt (15 µm) (Stoff Gepolstert)



85,5%

EN 1335

EN 1022

EN 1728

EN 16139

D.Les 81

EN 9175

5 YEAR WARRANTY

CETAS

TUV

ISO 9001:2008

ISO 14001:2004

OHSAS 18001:2007

TUV

GS

ID 1111209602

Alia

options

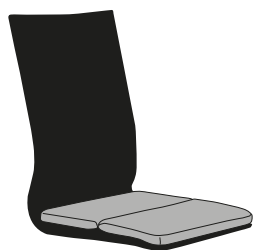

XC005 - seat cushion

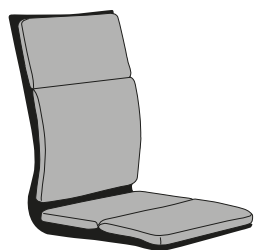

XC006 - high cushion

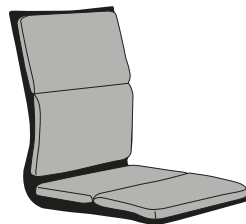

XC007 - medium cushion



XC008 - high cushion
XC010 - medium cushion

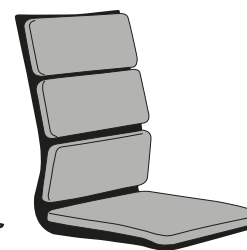

XC003 - high cushion

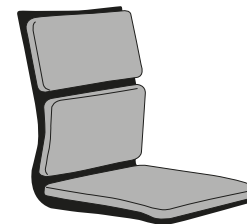

XC004 - medium cushion

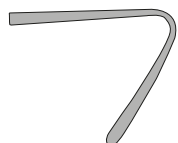

XB005 - metal arm.

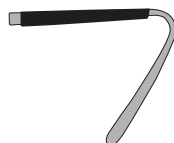

XB008 - metal arm.
uph. pad

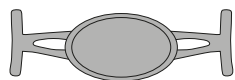

lumbar support
XR001 - beige
XR006 - black



footrest ring (high gas lift only)
XP001

TOP
collection

AliaC
design: Ambostudio

Il caratteristico traverso a forma di C posto sopra lo schienale, impreziosisce la ALIA, ma soprattutto la rende funzionale a numerosi spazi collettivi.

The characteristic "C" shaped backrest bar enhance the ALIA, making it functional for various collective ambient.

Le caractéristique traverse en forme de "C" placé au-dessus du dossier, enrichit le ALIA et surtout le rend fonctionnel à de nombreux espaces collectifs.

Die charakteristische C-förmige Querstange, oben auf der Rückenlehne angepasst, macht den Alia kostbar, aber vor allem funktionstüchtig zu vielen Gemeinschaftsräume.

TOP 57

AliaC

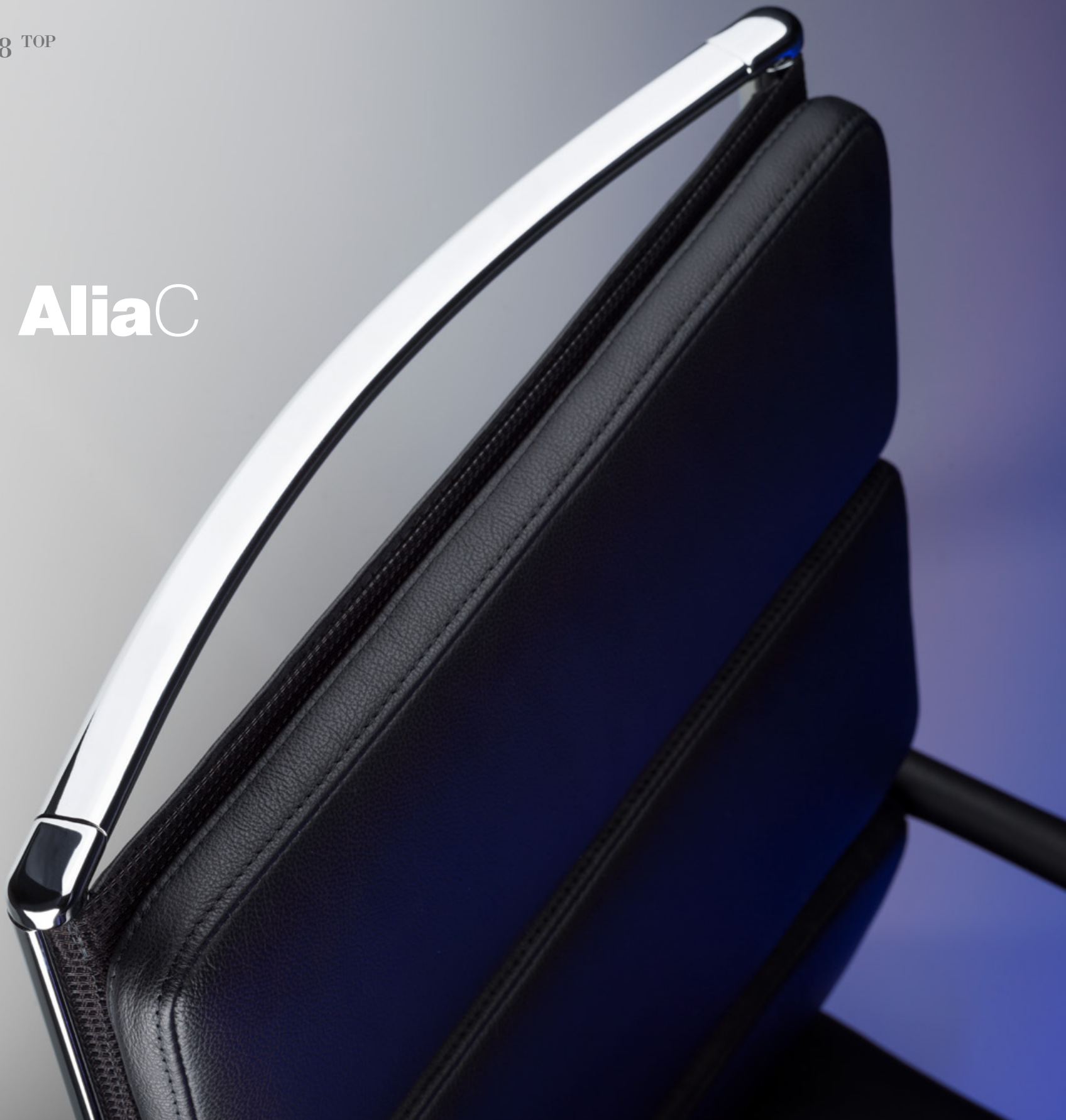

AliaC

Girevole, traverso "C".
Schienale medio o alto.

Swivel, "C" bar.
Medium or high backrest.

Pivotant, traverse "C".
Moyen ou haut dossier.

Drehebar, Querstange "C".
Mittlere oder hohe Rückenlehne.

versions

AliaC
High



AliaC
Medium



AliaC



AliaC
High & Medium



AliaC

Medium





technical data

mechanism

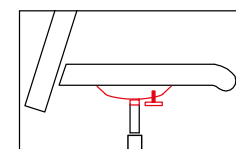

Piastra
Seat plate
Platine
Sitzplatte

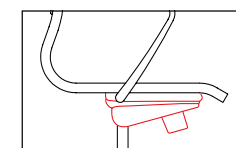

Meccanismo oscillante
Tilting mechanism
Mécanisme basculant
Wippmechanik

base



Base 4 razze in alluminio lucida
Polished aluminium 4 spoke base
Piètement 4 branches alu poli
Alu poliertes 4-Stern Fußkreuz



Base 4 razze in ferro cromata
4-spoke chromed iron base
Pièt. 4 branches en métal chromé
4-Stern verchromtes Eisen Fußkreuz



Base 5 razze in alluminio lucida
5-spoke polished aluminium base
Pièt. 5 branches alu poli
5-Stern Alu poliertes Fußkreuz

base



Base 5 razze in ferro cromata
5-spoke chromed iron base
Pièt. 5 branches en métal chromé
5-Stern verchromtes Eisen Fußkreuz

castors/feet

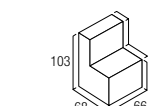
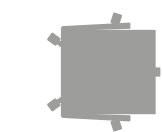
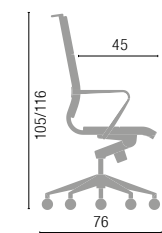

sostituito questo disegno
rispetto alla stampa

backrest
High

UNIT/PACK 1 - Kg 15,54 - m³ 0,4

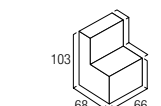
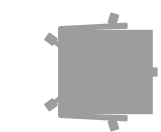
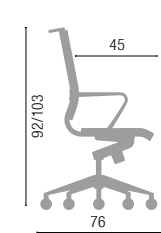
backrest
Medium

UNIT/PACK 1 - Kg 15,24 - m³ 0,4

stool

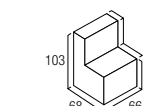
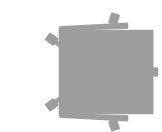
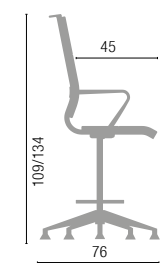

UNIT/PACK 1 - Kg 15,64 - m³ 0,4

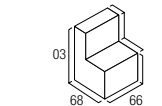
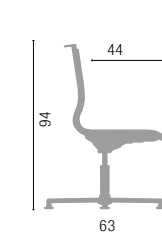
retour
Cylinder

UNIT/PACK 1 - Kg 14,84 - m³ 0,4



wellness and comfort

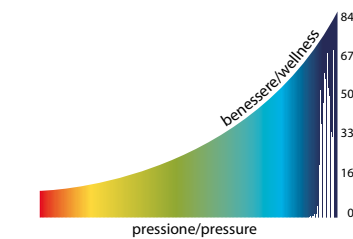

A Pressione sullo schienale di spalle e scapole
Shoulders and scapulas pressure on backrest
Pression des épaules et omoplates sur le dossier
Druck von der Schulter und Schulterblatt auf der Rückenlehne

B Pressione dell'area sacrale su supporto lombare
Sacrum pressure on lumbar support

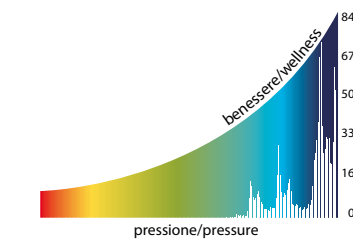

Pression sacrale sur le soutien lombaire
Druck im Bereich heiliger Knochen und Lendenwirbelstütze

C Pressione di bacino e cosce sul sedile
Hip and thigh pressure on seat
Pression des cuisses et du bassin sur l'assise
Druck im Becken und Oberschenkel auf dem Sitz

1. SCHIENALE:

Monoscocca in tubo sagomato d'acciaio, Ø 25mm, finitura cromata (15µm), rete portante a vista

2. MECCANISMO:

- Oscillante nero, comando elevazione a gas, regolazione tensione schienale, inclinazione 18° scocca in 5 posizioni con antishock
- Comando elevazione a gas, finitura nera

3. GAS:

- Regolabile in altezza, rotazione, finitura cromata, molleggio
- Regolabile in altezza, rotazione, finitura cromata
- Altezza fissa, ritorno automatico, finitura cromata
- Regolabile in altezza, rotazione, finitura cromata, sgabello

4. BASE:

- Base 5 razze in alluminio, Ø 710mm, finitura lucida
- Base 5 razze in ferro, Ø 710mm, finitura cromata (15µm)
- Base 4 razze in ferro, Ø 720mm, finitura cromata (15µm)
- Base 4 razze in alluminio, Ø 630mm, finitura lucida

5. RUOTE/PIEDINI:

- Ø 65mm, gommato o autofrenanti e gommato, finitura nera.
- Ruote Ø 50mm, autofrenanti o autofrenanti e gommato, finitura cromata
- Piedini in polimero termoplastico, h. 68mm, finitura cromata (15µm)
- Piedini in polimero termoplastico, h. 25mm, finitura cromata (15µm)
- Piedini in polimero termoplastico, h. 40mm, finitura cromata (15µm)

6. BRACCIOLI:

Bracciolo fisso in tubo tondo d'acciaio, Ø 25mm, finitura cromata (15µm) (rivestito in tessuto)

1. BACKREST:

Shaped steel tube monocoque, Ø 25mm, chromed finish (15µm), visible load bearing Mesh

2. MECHANISM:

- Black, tilting, gas lift height adj., backrest tension adj. 18° grade with 5 locking position, and antishock
- Height adjustable, Black finish

3. GAS LIFT:

- Height adjustable, swivel, chromed finish, shock absorber springs
- Height adjustable, swivel, chromed finish
- Not height adjustable, memory return cylinder, chromed finish
- Stool version height adjustable, swivel, chromed finish

4. BASE:

- Polished aluminium 5 spoke base, Ø 710 mm
- Iron 5 spoke base, Ø 710 mm chromed finish (15µm)
- Iron 4 spoke base, Ø 720 mm chromed finish (15µm)
- Polished aluminium 4 spoke base, Ø 630 mm

5. CASTORS/FEET:

- Ø 65mm self-braking castors, or soft self-braking, Black finish
- Ø 50 mm self-braking castors, or soft self-braking, Chromed finish
- h. 68mm Thermoplastic polymer gliders chromed finish (15µm)
- h. 25mm Thermoplastic polymer gliders chromed finish (15µm)
- h. 40mm Thermoplastic polymer gliders, chromed finish (15µm)

6. ARMREST:

Fixed armrest, round steel tube Ø 25mm, chromed finish (15µm), upholstered

1. DOSSIER:

Monocoque en tube d'acier Ø 25mm, finition chromée (15µm). Résille autoportante à vue

2. MECANISME:

- Basculant noir, réglage en hauteur, réglage de tension, inclinaison couche 18° en 5 positions avec système antichoc
- Réglable en hauteur, finition noir

3. VERIN A GAS:

- Réglable en hauteur, pivotant, finition chromé, amortisseur
- Réglable en hauteur, pivotant, finition chromé
- Hauteur fixe, retour automatique, finition chromé
- Réglable en hauteur, pivotant, finition chromé, tabouret

4. PIÈTEMENT:

- Piètement 5 branches alu poli, Ø 710mm
- Piètement 5 branches en métal, Ø 710mm, finition chromé (15µm)
- Piètement 4 branches en métal, Ø 720mm, finition chromé (15µm)
- Piètement 4 branches alu poli, Ø 630mm

5. ROULETTES/PATINS:

- Roulettes Ø 65mm, gommées ou autofreinantes et gommées, finition noir
- Roulettes Ø 50mm, autofreinantes ou autofreinantes et gommées, finition chromé
- Patins en polymère thermoplastique, h. 68mm, finition chromée (15µm)
- Patins polymère thermoplastique, h. 25mm, finition chromée (15µm)
- Patins polymère thermoplastique, h. 40mm, finition chromée (15µm)

6. ACCUDOIR:

Accoudoir fixe en tube rond d'acier, Ø 25mm, finition chromé (15µm) (tapissé)

1. RÜCKENLEHNE:

Geformtes Stahlrohr Gestell, Ø 25mm, verchromt (15µm) sichtbares tragendes Netz

2. MECHANIK:

- Schwarze Wippmechanik, Gaslift Höhenverstellung, Rückenlehne mit Spannungsregler, 18° Schalenneigung mit 5-stufiger Einstellung mit Antishock
- Schwarze Sitzhöhenverstellung

3. GASFEDER:

- Sitzhöhenverstellung, drehbar, verchromt, mit Stoßdämpfende Feder
- Sitzhöhenverstellung, drehbar, verchromt
- Rückholmmechanik ohne Sitzhöhenverstellung, verchromt
- Hocker Sitzhöhenverstellung, drehbar, verchromt

4. GESTELL:

- 5-Stern Alu poliertes Fußkreuz, Ø 710 mm
- 5-Stern Eisen Fußkreuz, Ø 710mm verchromt (15µm)
- 4-Stern Eisen Fußkreuz, Ø 720mm verchromt (15µm)
- 4-Stern Alu poliertes Fußkreuz, Ø 630 mm

5. ROLLEN/GLEITER:

- Ø 65 mm gebremste, oder weiche gebremste Rollen, schwarze
- Ø 50 mm gebremste, oder weiche gebremste rollen, verchromt
- Thermoplastische Polymergleiter, H. 68mm, verchromt (15 µm)
- Thermoplastische Polymergleiter, H. 25mm, verchromt (15 µm)
- Thermoplastische Polymergleiter, H. 40mm, verchromt (15 µm)

6. ARMLEHNEN

Feste Armlehne aus Stahlrohr, Ø 25 mm, verchromt (15 µm) (Stoff Gepolstert)



EN 1335

EN 1022

EN 1728

EN 16139

D.Les 81

EN 9175

5 YEAR WARRANTY

CE

ISO 9001:2008

ISO 14001:2004

ISO 18001:2007

TÜV Rheinland

GS

ID 1111209602

ISO 9001:2008

ISO 14001:2004

ISO 18001:2007

TÜV Rheinland

GS

ID 1111209602

AliaC

options

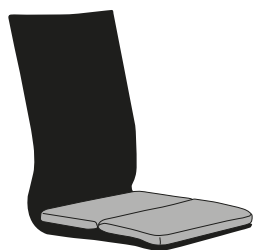

XC005 - seat cushion



XC001 - high cushion
XC002 - medium cushion

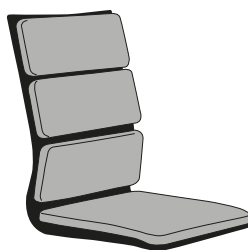

XC003 - high cushion

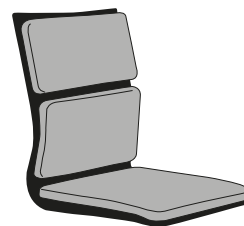

XC004 - medium cushion

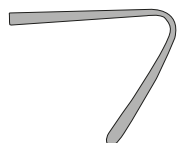

XB005 - metal arm.

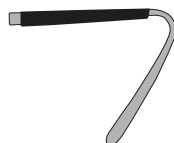

XB008 - metal arm.
uph. pad

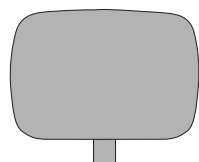

headrest
XT001



lumbar support
XR001 - beige
XR006 - black



footrest ring (high gas lift only)
XP001

ALIA TOP pone l'accento sui dettagli. La tappezzeria con pelli selezionate avvolge completamente la struttura in metallo. I traversi "C", posti su ambo i lati della scocca, enfatizzano la linee curve che contraddistinguono la seduta. La base in metallo da un senso di eleganza. Il meccanismo oscillante è studiato per garantire confort ed ergonomia. È la seduta ideale per il tuo ufficio di prestigio.

ALIA TOP is emphasize on the details. The upholstery with selected leathers wraps completely the metal structure. "C" bars, placed on both sides of the shell highlight the curved lines that characterized the chair. The metal base donate an outlook of elegance. The tilting mechanisms is designed to ensure comfort and ergonomics. Alia Top is the perfect chair for your prestigious office.

ALIA TOP met l'accent sur les détails. Le rembourrage en cuir de qualité enveloppe entièrement la structure en métal. Les traverses en forme de « C », installées en haut et en bas de la coque, mettent en évidence les lignes courbes qui distinguent le fauteuil. Le piètement en métal confère plus d'élégance. Le mécanisme basculant a été conçu pour garantir du confort et de l'ergonomie. C'est le fauteuil idéal pour un bureau de prestige.

ALIA TOP legt große Akzente auf die Details. Die Polsterung mit ausgewähltem Leder umwickelt völlig die Metallstruktur. Die C-förmigen Querstangen, oben und unten der Schale angepasst, betonen die gebogenen Linien die den Stuhl unterscheiden. Die Metallstruktur gibt ein Sinn der Eleganz. Die Wippmechanik ist entwickelt worden um Komfort und Ergonomie zu garantieren. Alia Top ist der richtige Stuhl für Ihr hochwertiges Büro.





AliaTop

Girevole, interamente tappezzata, doppio traverso. Schienale medio o alto.

Swivel, fully upholstered, double bar. Medium or high backrest.

Pivotant, entièrement tapissé, double traverse. Moyen ou haut dossier.

Drehbar, vollgepolstert, doppel Querstange. Mittlere oder hohe Rückenlehne.

versions

AliaTop
High



AliaTop
Medium



AliaTop

Medium



AliaTop

High & Medium





AliaTop



backrest
High

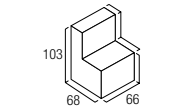
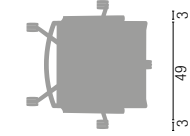
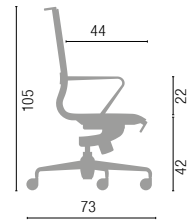

UNIT/PACK 1 - Kg 21,6 4 - m³ 0,4

backrest
Medium

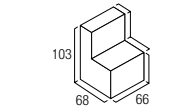
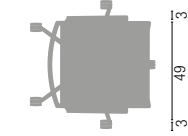
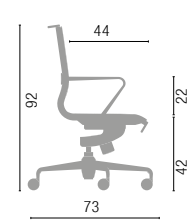

UNIT/PACK 1 - Kg 21,34 - m³ 0,4

technical data

mechanism

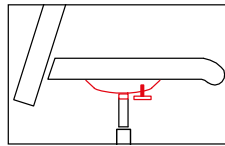

Piastra
Seat plate
Platine
Sitzplatte

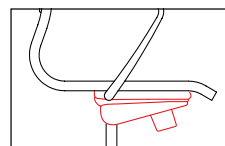

Meccanismo oscillante
Tilting mechanism
Mécanisme basculant
Wippmechanik

base



Base 5 razze in alluminio lucida
5-spoke polished aluminium base
Piët. 5 branches alu poli
5-Stern Alu poliertes Fußkreuz



base 5 razze in ferro cromata
5-spoke chromed iron base
piët. 5 branches en métal chromé
5-Stern verchromtes Eisen Fußkreuz

castors



options

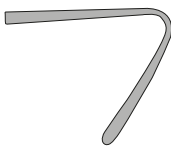

XB005 - metal arm.

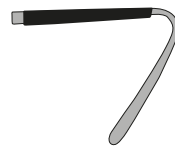

XB008 - metal arm.
uph. pad



A Pressione sullo schienale di spalle e scapole
Shoulders and scapulas pressure on backrest
Pression des épaules et omoplates sur le dossier
Druck von der Schulter und Schulterblatt auf der Rückenlehne

B Pressione dell'area sacrale su supporto lombare
Sacrum pressure on lumbar support

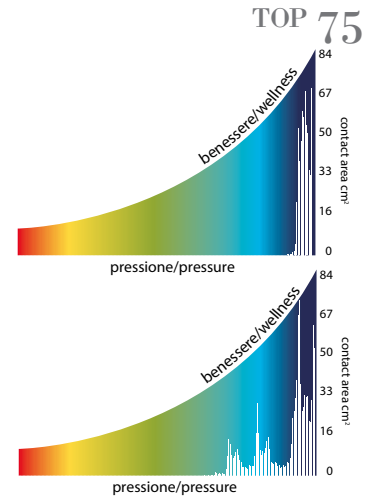

Pression sacrale sur le soutien lombaire
Druck im Bereich heiliger Knochen und Lendenwirbelstütze

C Pressione di bacino e cosce sul sedile
Hip and thigh pressure on seat
Pression des cuisses et du bassin sur l'assise
Druck im Becken und Oberschenkel auf dem Sitz

1. SCHIENALE:

Monoscocca in tubo sagomato d'acciaio, Ø 25mm, finitura cromata (15µm) rete portante, imbottita con spugna e rivestita in tessuto

2. MECCANISMO:

- Oscillante nero, comando elevazione a gas, regolazione tensione schienale, inclinazione 18°scocca in 5 posizioni con antishock
- Comando elevazione a gas, finitura nera

3. GAS:

- Regolabile in altezza, rotazione, finitura cromata, molleggio
- Regolabile in altezza, rotazione, finitura cromata

4. BASE:

- Base 5 razze in alluminio, Ø 710mm, finitura lucida
- Base 5 razze in ferro, Ø 710mm, finitura cromata (15µm)

5. RUOTE:

- Ruote Ø 65mm, gommata o autofrenanti e gommata, finitura nera.
- Ruote Ø 50mm, autofrenanti o autofrenanti e gommata, finitura cromata

6. BRACCIOLI:

Bracciolo fisso in tubo tondo d'acciaio, Ø 25mm, finitura cromata (15µm) (rivestito in tessuto)

1. BACKREST:

Shaped steel tube monocoque, Ø 25mm, chromed finish. (15µm), load bearing Mesh. Foam padded and fabric upholstered

2. MECHANISM:

- Black, tilting, gas lift height adj., backrest tension adj. 18°grade with 5 locking position, and antishock
- Height adjustable, Black finish

3. GAS LIFT:

- Height adjustable, swivel, chromed finish, shock absorber springs
- Height adjustable, swivel, chromed finish

4. BASE:

- Polished aluminium 5 spoke base, Ø 710 mm
- Iron 5 spoke base, Ø 710 mm chromed finish (15µm)

5. CASTORS:

- Ø 65mm self-braking castors, or soft self-bracking. Black finish
- Ø 50 mm self-braking castors, or soft self-bracking. Chromed finish

6. ARMREST:

Fixed armrest, round steel tube Ø 25mm, chromed finish (15µm), upholstered

1. DOSSIER:

Monocoque en tube d'acier Ø 25mm, finition chromée (15µm). Réseille autoportante rembourrée de mousse et tapissée en tissu.

2. MECANISME:

- Basculant noir, réglage en hauteur, réglage de tension, inclinaison coque 18°en 5 positions avec système antichoc
- Réglable en hauteur, finition noir

3. VERIN A GAZ:

- Réglable en hauteur, pivotant, finition chromé, amortisseur
- Réglable en hauteur, pivotant, finition chromé

4. PIETEMENT:

- Piètement 5 branches alu poli, Ø 710mm
- Piètement 5 branches en métal, Ø 710mm, finition chromé (15µm)

5. ROULETTES:

- Roulettes Ø 65mm, gommées ou autofreinantes et gommées, finition noir
- Roulettes Ø 50mm, autofreinantes ou autofreinantes et gommées, finition chromé

6. ACCUDOIR:

Accudoir fixe en tube rond d'acier, Ø 25mm, finition chromé (15µm) (tapissé)

1. RÜCKENLEHNE:

Geformtes Stahlrohr Gestell, Ø 25mm, verchromt (15µm) tragendes Netz, mit Schwamm gepolstert und mit Stoff bezogen

2. MECHANIK:

- Schwarze Wippmechanik, Gaslift Höhenverstellung, Rückenlehne mit Spannungsregler, 18° Schaleneigung mit 5-stufige Einstellung mit Antishock
- Schwarze Sitzhöhenverstellung

3. GASFEDER:

- Sitzhöhenverstellung, drehbar, verchromt, mit Stoßdämpfende Feder
- Sitzhöhenverstellung, drehbar, verchromt

4. GESTELL:

- 5-Stern Alu poliertes Fußkreuz, Ø 710 mm
- 5-Stern Eisen Fußkreuz, Ø 710mm verchromt (15µm)

5. ROLLEN:

- Ø 65 mm gebremste, oder weiche gebremste Rollen, schwarze
- Ø 50 mm gebremste, oder weiche gebremste rollen, verchromt

6. ARMLEHNEN

Feste Armlehne aus Stahlrohr, Ø 25 mm, verchromt (15 µm) (Stoff Gepolstert)



ID 1111209602

Alia

Visitor



Alia

AliaC

AliaTop

Visitor



Fissa, traverso standard o C, interamente tappezzata nella versione Top. Schienale medio.

Visitor, standard or "C" shaped backrest bar, fully upholstered on Top version. Medium backrest.

Visiteur, traverse standard ou "C", entièrement tapissé dans la version TOP. Dossier moyen.

Besucher, Querstange standard oder C, komplett vollgepolstert in der Ausführung Top. Mittlere Rückenlehne.

versions

Alia
AliaC
AliaTop
Visitor



Alia
AliaC
Bench



AliaTop

Visitor



Alia

Visitor



AliaC

Visitor



Russia



Alia AliaC

Visitor

disegni alia c con trasverso

backrest
Medium

bench 3

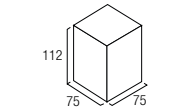
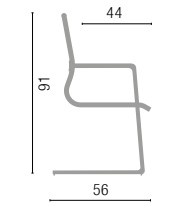

UNIT/PACK 1 - Kg 16,8 - m³ 0,5915

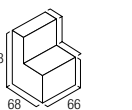
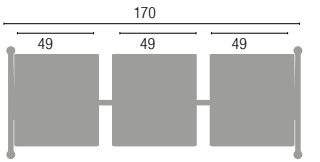
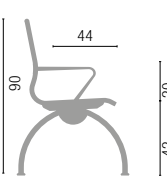

UNIT/PACK 1 - Kg 36,14 - m³ 0,4

technical data

options

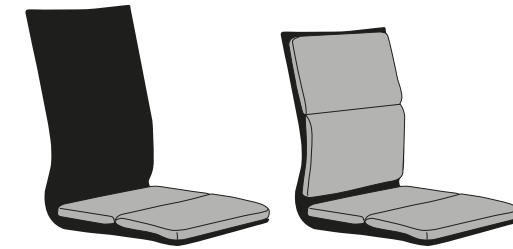

XC005 - seat cushion

XC007 - medium cushion

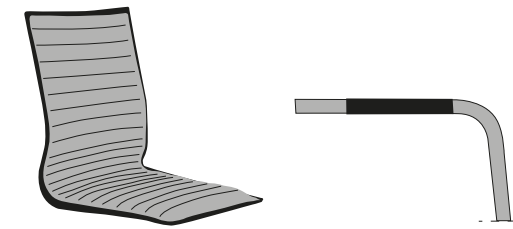

XC010 - XC002 medium cushion

XH001 - uph. pad

base



Base a slitta con braccioli cromata
Chromed cantilever base with arms
Pièd. luge chromé avec acc
Freischwinger Gestell verchromt mit Arm!



Alia trave 3P
Alia 3 seats bench version
Alia poutre 3 places
Alia 3 Sitzträger

feet



1. SCHIENALE:

Monoscocca in tubo sagomato d'acciaio, Ø 25mm, finitura cromata (15µm) rete portante a vista

2. BASE:

- Base a slitta in tubo d'acciaio Ø 25mm, finitura cromata (15µm)
- Trave in tubo rettangolare d'acciaio, 60x30mm, finitura cromata (15µm) con gambe in tubo tondo d'acciaio, Ø30mm, finitura cromata

3. PIEDINI:

- Tappi antiribaltamento in poliamide, finitura cromata (15µm)
- Piedini cromati

1. BACKREST:

Shaped steel tube monocoque, Ø 25mm, chromed finish. (15µm). Visible load bearing Mesh

2. BASE:

- Cantilever base, Ø 25 mm steel tube, chromed finish (15µm)
- Rect. Steel tube bar 60x30mm, chromed finish (15µm) with steel tube legs Ø30mm, chromed finish

3. FEET:

- Polyamide anti overturning plugs, chromed (15µm)
- Chromed Glides

1. DOSSIER:

Monocoque en tube d'acier Ø 25mm, finition chromée (15µm). Réseille autoportante à vue

2. PIÈTEMENT:

- Piètement luge en tube d'acier Ø 25mm, finition chromé (15µm)
- Poutre en tube d'acier rectangulaire, 60x30mm, finition chromé (15µm) avec pieds en tube d'acier, Ø30mm, finition chromé

3. PATINS:

- Tampons anti renversement en polyamide, finition chromé (15µm)
- Patins finition chromée

1. RÜCKENLEHNE:

Geformtes Stahlrohr Gestell, Ø 25mm, verchromt (15µm) sichtbares tragendes Netz à vue

2. GESTELL:

- Freischwinger Gestell, Ø 25mm Stahlrohr verchromt (15µm)
- Rechteckige Stahlrohrbalken, 60x30 mm, verchromt (15µm) mit Stahlrohrbeine, Ø 30 mm, verchromt

3. GLEITER:

- Anti Kippgleiter aus Polyamid, verchromt (15µm)
- Gleiter, verchromt



AliaTop

Visitor



TOP
collection

AliaTop

Visitor



modificato questo disegno
rispetto alla stampa

backrest
Medium

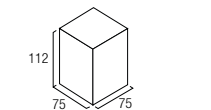
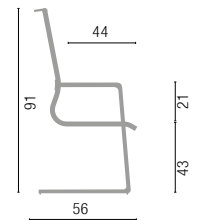

UNIT/PACK 1 - Kg 16,8 - m³ 0,5915

technical data

options

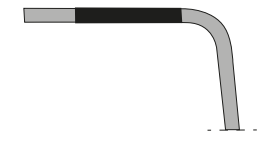

XH001 - uph. pad

1. SCHIENALE:

Monoscocca in tubo sagomato d'acciaio, Ø 25mm, finitura cromata (15µm), rete portante, imbottita con spugna e rivestita in tessuto

2. BASE:

Base a slitta in tubo d'acciaio Ø 25mm, finitura cromata (15µm)

3. PIEDINI:

Tappi antiribaltamento in poliamide, finitura cromata (15µm)

1. BACKREST:

Shaped steel tube monocoque, Ø 25mm, chromed finish. (15µm)
Load bearing Mesh. Foam padded and fabric upholstered

2. BASE:

Cantilever base, Ø 25 mm steel tube, chromed finish (15µm)

3. FEET:

Polyamide anti overturning plugs, chromed (15µm)

1. DOSSIER:

Monocoque en tube d'acier Ø 25mm, finition chromée (15µm). Résille autoportante rembourrée de mousse et tapissée en tissu.

2. PIÈTEMENT:

Piètement luge en tube d'acier Ø 25mm, finition chromé (15µm)

3. PATINS:

Tampons anti renversement en polyamide, finition chromé (15µm)

base



Base a slitta con braccioli cromata
Chromed cantilever base with arms
Piètl. luge chromé avec acc
Freischwinger Gestell verchromt mit Arml

feet



1. RÜCKENLEHNE:

Geformtes Stahlrohr Gestell, Ø 25mm, verchromt (15µm) tragendes Netz, mit Schwamm gepolstert und mit Stoff bezogen

2. GESTELL:

Freischwinger Gestell, Ø 25mm Stahlrohr verchromt (15µm)

3. GLEITER:

Anti Unkippleiter aus Polyamid, verchromt (15µm)



ID 1111209614

AliaLounge

design: Ambostudio

ALIA LOUNGE è stata studiata per regalare momenti di relax. Partendo dal design minimal e pulito della famiglia Alia si è voluto elevare la seduta creando qualcosa di esclusivo adatto per gli ambienti moderni, sia pubblici che privati. Alia Lounge è disponibile nella versione in rete o tappezzata in pelle, con lo schienale alto o basso. Tra le opzioni non manca l'appoggiapiedi anch'esso in rete o tappezzato.

ALIA LOUNGE have been designed to donate moments of relax. Inspired from the pure and minimal design of Alia family it have been created to elevate the existing alia chair in something exclusive. It is suitable for modern space, public or private areas. Alia lounge is available in mesh or in leather, with high or low back. Can not lack the optional footrest, it can be upholstered in mesh or in leather too.

ALIA LOUNGE a été conçue pour concéder des moments de relax. En partant du design minimaliste et poli de la gamme Alia, on a voulu progresser en créant un produit exclusif, apte à des ambiances modernes, soit privés que publiques. Alia Lounge est disponible dans la version en résille ou rembourrée en cuir, en dossier haut ou moyen. Parmi des options, l'appui-pieds lui-même en résille ou rembourré.

ALIA LOUNGE ist entworfen worden für angenehme Momente und zur Entspannung. Aus dem sauberen und minimalistischen Design von der Alia Stuhlfamilie, wurde ein exklusives Modell hergestellt, geeignet für moderne Räume im öffentlichen und privaten Bereich. Alia Lounge ist erhältlich mit Netz oder Leder gepolstert, mit hohe oder niedrige Rücklehne. Unter den Optionen gibt es auch eine Fußstütze immer mit Netz oder Leder gepolstert.





AliaLounge
High & Footrest

AliaLounge

Girevole, interamente tappezzata o rete.
Schienale medio o alto. Poggiapiedi.

Swivel fully upholstered, or mesh.
Medium or high backrest. Footrest.

Pivotant entièrement tapissé, ou résille.
Moyen ou haut dossier. Appui-pieds.

Drehbar Ausgepolstert oder
Netz. Mittlere oder hohe Rückenlehne.
Fußstütze.



versions

AliaLounge
High



AliaLounge
Medium



AliaLounge
Footrest



AliaLounge

High



AliaLounge

Medium



AliaLounge



technical data

mechanism

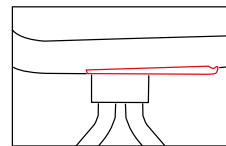

Piastra senza paletta
Flat metal plate
Platine sans palette
Sitzplatte ohne Hebel

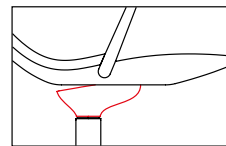

Molla oscillante
Tilting spring
Ressort basculant
Feder Wippmechanik

base



Base 4 razze in ferro cromata
4-spoke chromed iron base
Pièr. 4 branches en métal chromé
4-Stern verchromtes Eisen Fußkreuz

feet



options

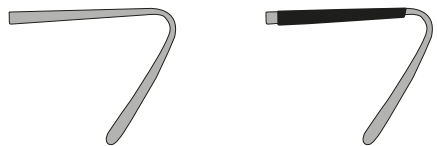

XB005 - metal arm.

XB008 - metal arm.
uph. pad

backrest High

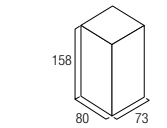
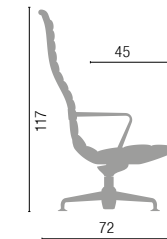

UNIT/PACK 1 - Kg 24,55 - m³ 0,923

backrest Medium

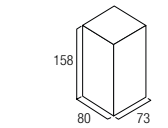
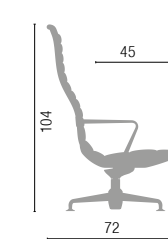

UNIT/PACK 1 - Kg 23,85 - m³ 0,923

Footrest

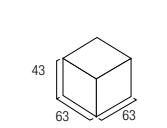
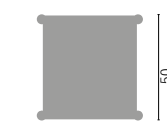

UNIT/PACK 1 - Kg 12,286 - m³ 0,15834



1. SCHIENALE:

Monoscocca in tubo sagomato d'acciaio, Ø 25mm, finitura cromata (15µm). Rete portante a vista o imbottita con spugna e rivestita in tessuto

2. MECCANISMO:

Molla oscillante in alluminio cromato, comando elevazione a gas

3. GAS:

Altezza fissa, rotazione, finitura cromata

4. BASE:

Base 4 razze in ferro, Ø 720mm, finitura cromata (15µm)

5. PIEDINI:

Piedini in polimero termoplastico, h. 25mm, finitura cromata (15µm)

6. BRACCIOLI:

Bracciolo fisso in tubo tondo d'acciaio, Ø 25mm, finitura cromata (15µm) (rivestito in tessuto)

1. BACKREST:

Shaped steel tube monocoque, Ø 25mm, chromed finish. (15µm). Visible load bearing Mesh or foam padded and fabric upholstered

2. MECHANISM:

Aluminium chromed tilting spring, gas lift height adjustment.

3. GAS LIFT:

Not height adjustable, chromed finish

4. BASE:

Iron 4 spoke base, Ø 720 mm chromed finish (15µm)

5. FEET:

h.25mm Thermoplastic polymer gliders chromed finish (15µm)

6. ARMREST:

Fixed armrest, round steel tube Ø 25mm, chromed finish (15µm), upholstered

1. DOSSIER:

Monocoque en tube d'acier Ø 25mm, finition chromée (15µm). Résille autoportante à vue ou rembourrée de mousse et tapissée en tissu

2. MECANISME:

Ressort basculant en aluminium poli Réglable en hauteur, finition noir

3. VERIN A GAZ:

Hauteur fixe, pivotant, finition chromé

4. PIÈTEMENT:

Piètement 4 branches en métal, Ø 720mm, finition chromé (15µm)

5. PATINS:

h.25mm Thermoplastique polimère, finition chromée (15µm)

6. ACCUDOIR:

Accoudoir fixe en tube rond d'acier, Ø 25mm, finition chromé (15µm) (tapissé)

1. RÜCKENLEHNE:

Geformtes Stahlrohr Gestell, Ø 25mm, verchromt (15µm) sichtbares tragendes Netz, mit Schwamm gepolstert und mit Stoff bezogen

2. MECHANIK:

Aluminium polierte Feder Wippmechanik, Gaslift Höhenverstellung

3. GASFEDER:

Ohne Sitzhöhenverstellung, verchromt

4. GESTELL:

4-Stern Eisen Fußkreuz, Ø720mm verchromt (15µm)

5. GLEITER:

Thermoplastische Polymergleiter, H.25mm, verchromt (15 µm)

6. ARMLEHNEN

Feste Armlehne aus Stahlrohr, Ø 25 mm, verchromt (15 µm) (Stoff Gepolstert)



Viva

design: AZ Creations

VIVA è un'innovativa poltrona direzionale. Il bracciolo cromato che corre dietro lo schienale dona alla seduta un tocco di eleganza; grazie al nuovissimo bracciolo chiuso tappezzato Viva acquista un'immagine di solidità e imponenza capace di renderla il punto focale dell'ambiente in cui è collocata. È disponibile sia in versione girevole sia con base fissa a slitta. Il meccanismo oscillante bileva con punto di rotazione avanzato e con regolatore di tensione garantisce affidabilità e comfort. Viva è adatta alle persone che amano il fascino dell'eleganza ma non vogliono rinunciare alla comodità.

VIVA is an innovative directional armchair. The chromed armrest that runs behind the backrest gives the chair a touch of elegance; thanks to its newly closed completely upholstered armrest Viva conveys an image of solidity and magnificence able to make it the focal point of the environment in which it is located. It is available in both swivel version and fixed with cantilever base. The advanced rotation pointy tilting mechanism equipped with tension regulator ensures reliability and comfort. Viva is suitable for people who love the charm of elegance but do not want to renounce to comfort.

VIVA est un fauteuil de direction innovant. L'accoudoir chromé qui passe derrière le dossier donne au fauteuil une touche d'élégance ; grâce au nouveau accoudoir fermé, entièrement tapissé Viva gagne une image de solidité et de grandeur qui en font le point focal de l'espace dans lequel il se trouve. Il est disponible soit dans la version pivotante soit dans la version d'attente en piètement luge. Le mécanisme basculant décalé avec réglage en intensité assure fiabilité et confort. Viva est apte à ceux qui aiment le charme de l'élégance et qui ne veulent pas renoncer au confort.

VIVA ist ein innovativer Büro-Sessel für Direktionsbereiche. Die verchromte Armlehne läuft hinter der Rückenlehne und verleiht dem Stuhl Eleganz; Dank die neue geschlossene und gepolsterte Armlehne, erwirbt Viva ein Solides und Stattliches Aussehen, so dass dieser Sessel der Mittelpunkt des Raumes darstellt. Er ist Verfügbar als Drehstuhl oder mit festen Freischwinger Gestell. Die Wipp-Mechanik mit vorgeschobenen Drehpunkt, ist mit Spannungsregler und zwei Hebel ausgestattet und garantiert Zuverlässigkeit und Sitzkomfort. Viva ist für Menschen geeignet die Eleganz lieben ohne auf den Komfort zu verzichten.

Viva

Armrest



Viva

Girevole, imbottita.
Schienale alto.

Swivel, upholstered.
High backrest.

Pivotant, rembourré.
Haut dossier.

Drehbar, gepolstert.
Hohe Rückenlehne.

versions



Viva
Headrest



Viva
Headrest



Viva



Viva





backrest
Headrest

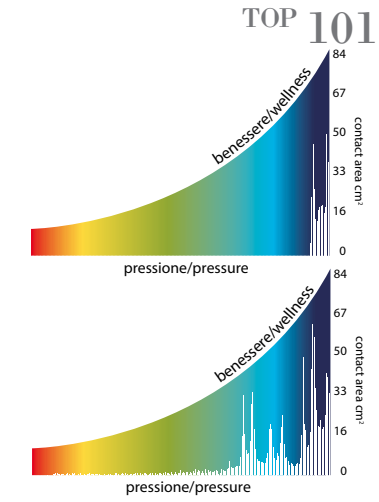
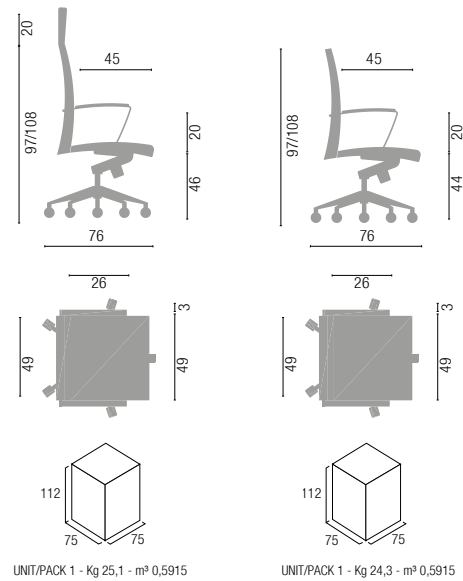

- A** Pressione sullo schienale di spalle e scapole
Shoulders and scapulas pressure on backrest
Pression des épaules et omoplates sur le dossier
Druck von der Schulter und Schulterblatt auf der Rückenlehne
- B** Pressione dell'area sacrale su supporto lombare
Sacrum pressure on lumbar support

- Pression sacrale sur le soutien lombaire
Druck im Bereich heiliger Knochen und Lendenwirbelstütze
- C** Pressione di bacino e cosce sul sedile
Hip and thigh pressure on seat
Pression des cuisses et du bassin sur l'assise
Druck im Becken und Oberschenkel auf dem Sitz

technical data

mechanism

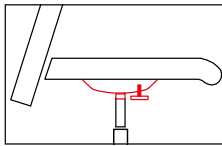

Piastra
Seat plate
Platine
Sitzplatte

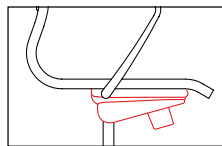

Meccanismo oscillante
Tilting mechanism
Mécanisme basculant
Wippmechanik

base



Base 5 razze in alluminio lucida.
5-spoke polished aluminium base.
Piè. 5 branches alu poli.
5-Stern Alu poliertes Fußkreuz.



Base 5 razze in ferro cromata.
5-spoke chromed iron base.
Piè. 5 branches en métal chromé.
5-Stern verchromtes Eisen Fußkreuz.

castors



options

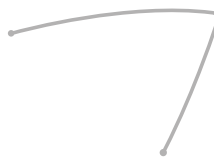

XB013 - metal arm.

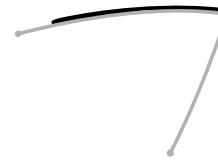

XB016 - metal arm.
uph. pad

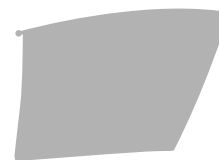

XB014 - uph. metal arm.

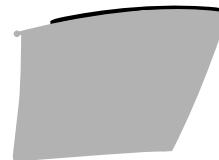

XB015 - uph. metal arm.
uph. pad



headrest
XT006

1. SCHIENALE:

Schienale in spugna schiumata a freddo con struttura portante in tubo quadro d'acciaio, 15x15mm, rivestita in tessuto

2. SEDILE:

Sedile in spugna schiumata a freddo con struttura portante in tubo tondo d'acciaio, Ø 16mm, rivestita in tessuto

3. MECCANISMO:

- Oscillante nero, comando elevazione a gas, regolazione tensione schienale, inclinazione 18°scocca in 5 posizioni con antishock
- Comando elevazione a gas, finitura nera

4. GAS:

- Regolabile in altezza, rotazione, finitura cromata
- Regolabile in altezza, rotazione, finitura cromata, molleggio

5. BASE:

- Base 5 razze in ferro, Ø 710mm, finitura cromata (15µm)
- Base 5 razze in alluminio, Ø 710mm, finitura lucida

6. RUOTE:

- Ø 65mm, gommata o autofrenanti e gommata, finitura nera.
- Ø 50mm, autofrenanti o autofrenanti e gommata, finitura cromata

7. BRACCIOLI:

Bracciolo fisso in piatto d'acciaio, 25x5mm, finitura cromata (15µm) (imbottito e rivestito in tessuto)

1. BACKREST:

Cold injected foam padded backrest steel square tube, 15x15mm structure, fabric upholstery

2. SEAT:

Cold injected foam padded seat, steel round bar Ø16mm structure, fabric upholstery

3. MECHANISM:

- Black, tilting, gas lift height adj., backrest tension adj., 18°grade with 5 locking position, and antishock
- Height adjustable, Black finish

4. GAS LIFT:

- Height adjustable, swivel, chromed finish
- Height adjustable, swivel, chromed finish, shock absorber springs

5. BASE:

- Iron 5 spoke base, Ø 710 mm chromed finish (15µm)
- Polished aluminium 5 spoke base, Ø 710 mm

6. CASTORS:

- Ø 65mm self-braking castors, or soft self-bracking. Black finish
- Ø 50 mm self-braking castors, or soft self-bracking. Chromed finish

7. ARMREST:

Steel plate fixed armrest, 25x5mm, chromed finish (15µm), padded and upholstered

1. DOSSIER:

Dossier en mousse moulée à froids avec châssis en tube d'acier carré, 15x15mm, tapissé

2. ASSISE:

Assise en mousse moulée à froids avec châssis en tube d'acier rond, Ø 16mm, tapissée

3. MECANISME:

- Basculant noir, réglage en hauteur, réglage de tension, inclinaison coque 18° en 5 positions avec système antichoc
- Réglable en hauteur, finition noir

4. VERIN A GAZ:

- Réglable en hauteur, pivotant, finition chromé
- Réglable en hauteur, pivotant, finition chromé, amortisseur

5. PIETEMENT:

- Piètement 5 branches alu poli, Ø 710mm
- Piètement 5 branches en métal, Ø 710mm, finition chromé (15µm)

6. ROULETTES:

- Roulettes Ø 65mm, gommées ou autofreinantes et gommées, finition noir
- Roulettes Ø 50mm, autofreinantes ou autofreinantes et gommées, finition chromé

7. ACCUDOIR:

Accoudoir fixe plat en acier, 25x5mm, finition chromé (15µm) (rembourré et tapissé)

1. RÜCKENLEHNE:

Kaltgeschäumten Polyurethan, mit Stoffbezug. 15x15mm Vierkantstahlrohr Schale

2. SITZ:

Ø 16mm Stahlstab schale, ausgepolstert mit kaltgeschäumten Polyurethan, mit Stoffbezug

3. MECHANIK:

- schwarze Wippmechanik, Gaslift Höhenverstellung, Rückenlehne mit Spannungsregler, 18°Schaleneigung mit 5-stufige Einstellung
- schwarze Einstellung
- Sitzhöhenverstellung

4. GASFEDER:

- Sitzhöhenverstellung, drehbar, verchromt
- Sitzhöhenverstellung, drehbar, verchromt, mit Stoßdämpfende Feder

5. GESTELL:

- 5-Stern Alu poliertes Fußkreuz, Ø 710 mm
- 5-Stern Eisen Fußkreuz, Ø710mm verchromt (15µm)

6. ROLLEN:

- Ø 65 mm gebremste, oder weiche gebremste Rollen, schwarze
- Ø 50 mm gebremste, oder weiche gebremste Rollen, verchromt

7. ARMLEHNEN

Feste Armlehne aus Flachstahl, 25x5 mm, verchromt (15 µm) (ausgepolstert mit Stoff bezogen)

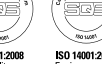



Viva
Visitor

France



Viva

Visitor

Fissa, imbottita.
Schienale medio.

Visitor, upholstered.
Medium backrest

Visiteur rembourré.
Dossier moyen.

Besucher gepolstert.
Mittlere Rückenlehne.

versions

Viva
Visitor



Viva

Visitor



TOP
collection

Viva

Visitor

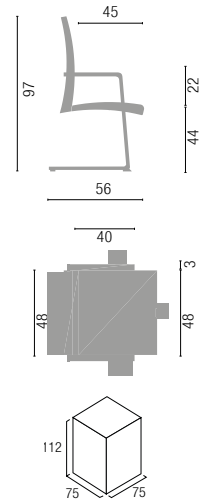

UNIT/PACK 1 - Kg 24,8 - m³ 0,5915

technical data

options



XH005 - uph. pad

base



Base a slitta con braccioli cromata.
Chromed cantilever base with arms.
Pièd. luge chromé avec acc.
Freischwinger Gestell verchromt mit Arml.

feet



1. SCHIENALE:

Schienale in spugna schiumata a freddo con struttura portante in tubo quadro d'acciaio, 15x15mm, rivestita in tessuto

2. SEDILE:

Sedile in multistrato di legno con spugna schiumata a freddo, rivestita in tessuto

3. BASE:

Base a slitta in tubo rettangolare d'acciaio, 30x15mm, finitura cromata (15µm)

4. PIEDINI:

Tappi antiribaltamento in poliamide, finitura cromata (15µm)

1. BACKREST:

Cold injected foam padded backrest steel square tube, 15x15mm structure, fabric upholstery

2. SEAT:

Plywood seat, cold injected foam padded, fabric upholstery

3. BASE:

Cantilever base, 30x15mm, rect. Steel tube, chromed finish (15µm)

4. FEET:

Polyamide anti overturning plugs, chromed finish (15µm)

1. DOSSIER:

Dossier en mousse moulée à froids avec châssis en tube d'acier carré, 15x15mm, tapissé

2. ASSISE:

Assise en multiplie de bois, rembourré de mousse moulé à froids, tapissée

5. PIÈTEMENT:

Piètement luge en tube d'acier rectangulaire, 30x15mm, finition chromé (15µm)

6. PATINS:

Tampons anti renversement en polyamide, finition chromé (15µm)

1. RÜCKENLEHNE:

Kaltgeschäumten Polyurethan, mit Stoffbezug. 15x15mm Vierkantstahlrohr Schale

2. SITZ:

Holzstiz, ausgepolstert mit Kaltgeschäumten Polyurethan, mit Stoffbezug

5. GESTELL:

Kufengestell, 30x15mm Vierkantstahlrohr, verchromt (15µm)

6. GLEITER:

Anti Unkippleiter aus Polyamid, verchromt (15µm)



EN 1335

EN 1022

D.Lgs 81

EN 1728

EN 16139

EN 9175

5 YEAR WARRANTY



Certification and guarantee of absolute product quality



IONet Certified Management System



ISO 9001:2008 Quality



ISO 14001:2004 Environmental



OHSAS 18001:2007 Safety

Forma

design: AZ Creations

FORMA è una famiglia di sedute direzionali e semi-direzionali ad alto contenuto tecnologico. Il robusto schienale in poliuretano e l'innovativo sistema di molle imbustate all'interno del sedile creano una simbiosi di comfort-eleganza molto lineare e accattivante.

FORMA è disponibile con schienale alto oppure basso; nello schienale alto è possibile applicare anche l'appoggiatesta; i braccioli possono essere fissi oppure regolabili.

FORMA is a family of executive and semi-directional high-tech chairs. The strong polyurethane backrest and the innovative single-packed spring system inserted in the seat create a very attractive symbiosis of comfort and elegance. FORMA is available with low or high backrest, in the high back version it is also possible to fix the headrest; the armrests can be fixed or adjustable.

FORMA est une famille de fauteuils de direction et semi-direction de haute technologie. Le dossier robuste en polyuréthane et le système de ressorts ensachés singulièrement dans l'assise créent une symbiose très captivante entre le confort et l'élégance. FORMA est disponible en bas ou haut dossier, sur la version haut dossier on peut également appliquer l'appui-tête ; les accoudoirs peuvent être fixes ou réglables.

FORMA ist eine Drehstuhlfamilie für Direktionsbereiche und Geschäftsleitungen mit hohem Technologischen Inhalt. Die starke Rückenlehne aus Polyurethan und das innovative Federungssystem im Sitz eingebaut erlauben eine lineare und einnehmende Symbiose zwischen Komfort und Eleganz. Verfügbar mit hohe oder niedrige Rückenlehne; auf der hohe Rücklehne kann man auch die Kopfstütze einsetzen; die Armlehne sind verstellbar oder fest.

Forma



Forma

Girevole, imbottita, molle sedile.
Schienale medio o alto.

Swivel, upholstered, seat springs.
Medium or high backrest.

Pivotant, rembourré, ressorts assise.
Moyen ou haut dossier.

Drehbar, gepolstert, Federkern im Sitz.
Mittlere oder hohe Rückenlehne.



versions



110 TOP



Forma
Headrest

TOP 111

Forma
Headrest & High



Forma

High



Forma

Medium



Forma



technical data

mechanism

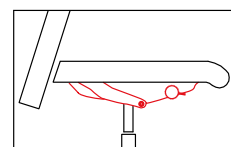

Meccanismo SynchroPlus+ con traslazione sedile
SynchroPlus+ mechanism with sliding seat device
Mécanisme SynchroPlus+ avec translation d'assise
SynchroPlus+ Mechanik mit Schiebesitz

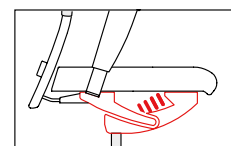

Meccanismo SynchroTeK nero con traslazione sedile, inclinazione negativa
Black SynchroTeK mechanism with sliding seat device, negative angle adj
Mécanisme SynchroTeK noir avec translation et réglage négatif d'assise
Schwarze SynchroTeK Mechanik mit Schiebe- und Sitzneigung

base



Base 5 razze in alluminio lucida
5-spoke polished aluminium base
Pièr. 5 branches alu poli
5-Stern Alu poliertes Fußkreuz

castors

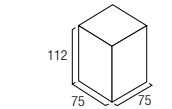
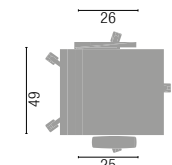
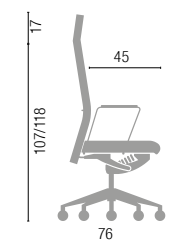
backrest
Headrest

UNIT/PACK 1 - Kg 24,05 - m³ 0,5915

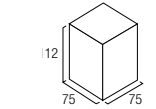
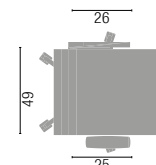
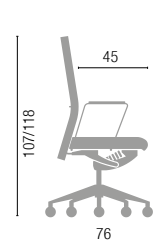
backrest
High

UNIT/PACK 1 - Kg 24,05 - m³ 0,5915

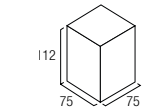
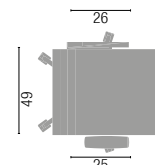
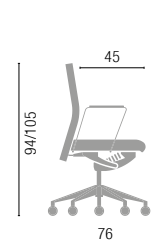
backrest
Medium

UNIT/PACK 1 - Kg 23,45 - m³ 0,5915



wellness and comfort

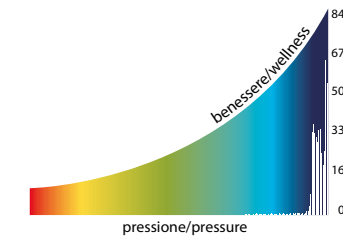

A Pressione sullo schienale di spalle e scapole
Shoulders and scapulas pressure on backrest
Pression des épaules et omoplates sur le dossier
Druck von der Schulter und Schulterblatt auf der Rückenlehne

B Pressione dell'area sacrale su supporto lombare
Sacrum pressure on lumbar support

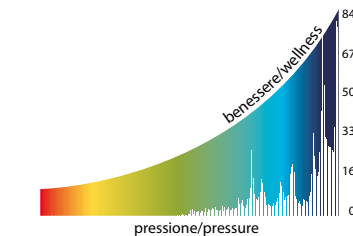

Pressione sacrale sur le soutien lombaire
Druck im Bereich heiliger Knochen und Lendenwirbelstütze

C Pressione di bacino e cosce sul sedile
Hip and thigh pressure on seat
Pression des cuisses et du bassin sur l'assise
Druck im Becken und Oberschenkel auf dem Sitz

1. SCHIENALE:

Schienale in spugna schiumata a freddo con struttura portante in tubo quadro d'acciaio, 15x15mm, rivestita in tessuto (poggiareni in poliamide integrato nello schienale)

2. SEDILE:
Sedile in polipropilene imbottito con spugna, rivestita in tessuto

3. MECCANISMO:

- SynchroTeK cromato o nero, comando elevazione a gas, regolazione tensione schienale: inclinazione 26°sch. 10,5°sed. in 5 posizioni con antishock, inclinazione negativa sed. 4,5° traslazione sed. 6cm in 5 posizioni
- SynchroPlus+, comando elevazione a gas, regolazione tensione schienale, inclinazione 20°sch. 8°sed. in 5 posizioni con antishock, traslazione sed. 6cm in 5 posizioni

4. GAS:

- Regolabile in altezza, rotazione, finitura cromata
- Regolabile in altezza, rotazione, finitura cromata, molleggio

5. BASE: Base 5 razze in alluminio, Ø 710mm, finitura lucida

6. RUOTE:

Ø 65mm, gommate o autofrenanti e gommate, finitura nera.

7. BRACCIOLI:

- Bracciolo fisso in piatto d'acciaio, 30x5mm, finitura cromata (15µm) (rivestito in tessuto)
- Bracciolo regolabile in tubo ellittico d'acciaio, 40x20mm, finitura cromata (15µm) o verniciata a polveri, con top in poliamide, finitura nera, finitura nera, o top in poliuretano morbido
- Bracciolo regolabile in 4D in tubo ovale d'acciaio, 45x25mm, finitura cromata, con top in poliuretano morbido
- Bracciolo regolabile in poliamide, finitura nera, con top in poliuretano morbido

1. BACKREST:

Cold injected foam padded backrest steel square bar 15x15mm structure, fabric upholstery (integrated polyamide lumbar support)

2. SEAT:

Polypropylene seat, foam padded, fabric upholstery

3. MECHANISM:

- Chromed or black SynchroTeK, gas lift height adj. Backrest tension adj. Backrest inclination: 26° in 5 positions with antishock; Seat inclination: 10,5°. Negative seat inclination: 4,5°. Sliding seat device 6cm in 5 positions
- SynchroPlus+, gas lift height adj. Backrest tension adj. backrest inclination 20° in 5 locking position with antishock, seat inclination 8°. Sliding seat device 6cm in 5 positions

4. GAS LIFT:

- Height adjustable, swivel, chromed finish
- Height adjustable, swivel, chromed finish, shock absorber springs

5. BASE:

- Polished aluminium 5 spoke base, Ø 710 mm

6. CASTORS:

- Ø 65mm self-braking castors, or soft self-bracking. Black finish

7. ARMREST:

- Steel plate fixed armrest, 30x5mm, chromed finish (15µm), upholstered
- Height adj. Armrest, Ellipt. Steel tube 40x20mm, chromed finish (15µm) or powder coated, polyamide pad, black finish or soft polyurethane pad.
- 4D ADJ. ARMREST, in oval steel tube 45x25mm, chromed finish, soft polyurethane pad
- Black Polyamide adj. armrest, black polyamide top or soft black polyurethane pad

1. DOSSIER:

Dossier en mousse moulée à froids avec châssis en tube d'acier carré, 15x15mm, tapissé. Soutien lombaire intégré

2. ASSISE:

Assise en polypropylène rembourrée de mousse moulée à froids, tapissée

3. MECANISME:

- SynchroTeK chromé ou noir, réglage en hauteur, réglage de tension, inclinaison dossier 26°et assise 10,5°, en 5 positions avec système antichoc, inclinaison négative assise 4,5°, profondeur d'assise 6 cm en 5 positions
- SynchroPlus+, réglage en hauteur, réglage de tension, inclinaison dossier 20°et assise 8°, en 5 positions avec système anti-choc, profondeur d'assise 6 cm en 5 positions

4. VERIN A GAZ:

- Réglable en hauteur, pivotant, finition chromé
- Réglable en hauteur, pivotant, finition chromé, amortisseur

5. PIETEMENT:

Piètement 5 branches alu poli, Ø 710mm

6. ROULETTES:

Roulettes Ø 65mm, gommées ou autofreinantes et gommées, finition noir

7. ACCUDOIR:

- Accoudoir fixe plat en acier, 30x5mm, finition chromé (15µm) (tapissé)
- Accoudoir réglable en tube d'acier elliptique, 40x20mm, finition chromé (15µm) ou verni époxy, manchette en polyamide, finition noir ou en polyuréthane souple
- Accoudoir réglable en 4D en tube ovale d'acier, 45x25mm, finition chromé, manchette en polyuréthane souple
- Accoudoir réglable en polyamide, finition noir, manchette en polyamide, finition noir ou en polyuréthane souple

1. RÜCKENLEHNE:

Kaltgeschäumten Polyurethan Rückenlehne, mit Stoffbezug, 15x15mm Vierkant Stahlrohr Schale (Integrierte ausgepolsterte Polyamid Lumbalstütze mit Stoffbezug)

2. SITZ:

Polypropylen Sitz, ausgepolstert mit kaltgeschäumten Polyurethan, mit Stoffbezug

3. MECHANIK:

- SynchroTeK verchromt oder schwarz, Gaslift Höhenverstellung, Rückenlehne mit Spannungsregler, 26°Rückenlehneigung, 10,5°Sitzneigung, negative Sitzneigung 4,5°, 5-stufige Einstellung mit Antishock, 6 cm Sitztiefenverstellung mit 5 Positionen
- SynchroPlus+, Gaslift Höhenverstellung, Rückenlehne mit Spannungsregler, 20°Rückenlehneigung, 8°Sitzneigung, 5-stufige Einstellung mit Antishock, 6 cm Sitztiefenverstellung mit 5 Positionen

4. GASFEDER:

- Sitzhöhenverstellung, drehbar, verchromt
- Sitzhöhenverstellung, drehbar, verchromt, mit Stoßdämpfende Feder

5. GESTELL:

5-Stern Alu poliertes Fußkreuz, Ø 710 mm

6. ROLLEN:

Ø 65 mm gebremste, oder weiche gebremste Rollen, schwarze



EN 1335

EN 1022

D.Lgs 81

EN 1728

EN 16139

EN 9175

5 YEAR WARRANTY

CE

ISO 9001:2008

ISO 14001:2004

ISO 45001:2018

ISO 18001:2007

SAFETY

SAFETY

SAFETY

SAFETY

SAFETY

SAFETY

SAFETY

SAFETY

SAFETY

SAFETY

SAFETY

SAFETY

SAFETY

SAFETY

SAFETY

SAFETY

SAFETY

SAFETY

SAFETY

SAFETY

SAFETY

SAFETY

SAFETY

SAFETY

SAFETY

SAFETY

SAFETY

SAFETY

SAFETY

SAFETY

SAFETY

SAFETY

SAFETY

SAFETY

SAFETY

SAFETY

SAFETY

SAFETY

SAFETY

Forma

options

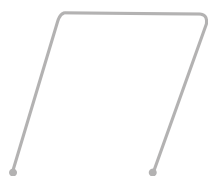

XB001 - metal arm.



XB002 - metal arm.
uph. pad

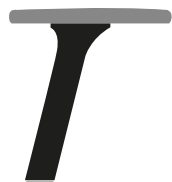

XB024 - chromed
4D soft pad

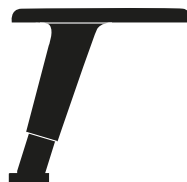

XB020 - 2D
XB021 - 3D

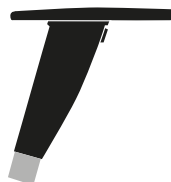

XB018 - chromed 2D
XB082 - chromed 3D

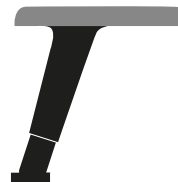

XB022 - 2D soft pad
XB023 - 3D soft pad

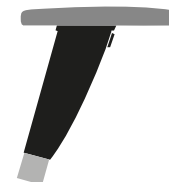

XB025 - chromed
2D soft pad
XB084 - chromed
3D soft pad



headrest
XT004

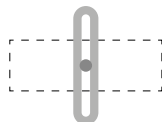

lumbar support
XR002 - high backrest
XR003 - medium backrest

Forma
Visitor



Forma
Visitor

TOP
collection

Forma

Visitor

technical data

options

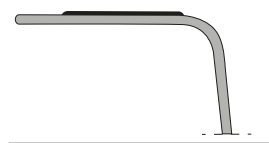

XH006 - uph. pad



4-legs

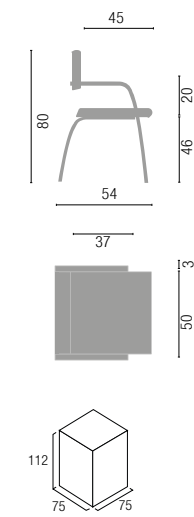

UNIT/PACK 1 - Kg 13,45 - m³ 0,5915

bench

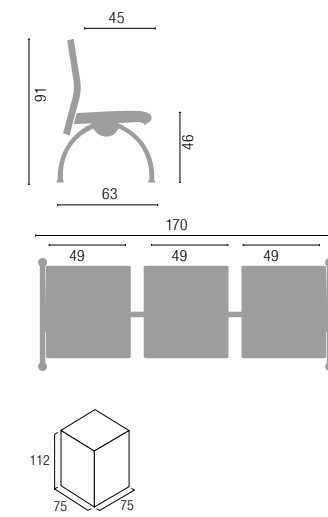

UNIT/PACK 1 - Kg 40 - m³ 0,5915

base

base 4 gambe con braccioli cromata
4-legs chromed base with arms
pièd. 4 pieds chromé avec acc.
4-Fuß Gestell verchromt mit Arml.Trave 3P
3 seats bench version
Poutre 3 places
3 Sitzträger

feet



1. SCHIENALE:

- Schienale in multistrato di legno, imbottito con spugna, rivestito in tessuto
- Schienale in spugna con struttura portante in tubo quadro d'acciaio, 15x15mm, rivestita in tessuto

2. SEDILE:

- Sedile per trave in polipropilene imbottito con spugna, rivestita in tessuto
- Sedile in multistrato di legno con spugna schiumata a freddo, rivestita in tessuto

3. BASE:

- Base 4 gambe in tubo rettangolare d'acciaio, 30x15mm, fin. cromata (15µm)
- Trave in tubo rettangolare d'acciaio, 60x30mm, finitura cromata (15µm) con gambe in tubo tondo d'acciaio, Ø30mm, finitura cromata

4. PIEDINI:

- Tappi in polipropilene, finitura nera

1. BACKREST:

- Plywood backrest, foam padded and fabric upholstery.
- Foam padded backrest, 15x15 mm square steel tube structure, fabric upholstered.

2. SEAT:

- Polypropylene seat, foam padded, fabric upholstery
- Plywood seat, cold injected foam padded, fabric upholstery

3. BASE:

- 4 legs base, 30x15mm rect. Steel tube, chromed finish (15µm)
- Rect. Steel tube bar 60x30mm, chromed finish (15µm) with steel tube legs Ø30mm, chromed finish

4. FEET:

- Polypropylene plugs, black finish

1. DOSSIER:

- Dossier en multiplie de bois, rembourré de mousse moulée à froids, tapissé
- Dossier en mousse moulée à froids avec châssis en tube d'acier carré, 15x15mm, tapissée

2. ASSISE:

- Assise en polypropylène rembourrée de mousse moulée à froids, tapissée
- Assise en multiplie de bois, rembourré de mousse moulée à froids, tapissés

5. PIÈTEMENT:

- Piètement 4 pieds en tube d'acier rectangulaire, 30x15mm, finition chromé (15µm)
- Poutre en tube d'acier rectangulaire, 60x30mm, finition chromé (15µm) avec pieds en tube d'acier, Ø30mm, finition chromé

6. PATINS:

- Tampons en polypropylène, finition noir

1. RÜCKENLEHNE:

- Holzrückenlehne, ausgepolstert mit kaltgeschäumten Polyurethan, mit Stoffbezug
- Kaltgeschäumten Polyurethan, mit Stoffbezug. 15x15mm Vierkantstahlrohr Schale

2. SITZ:

- Polypropylen Sitz, ausgepolstert mit kaltgeschäumten Polyurethan, mit Stoffbezug
- Holzstuhl, ausgepolstert mit Kaltgeschäumten Polyurethan, mit Stoffbezug

5. GESTELL:

- 4-Fuß Gestell, 30x15mm Vierkantstahlrohr verchromt (15µm)
- Rechteckige Stahlrohrbalken, 60x30 mm, verchromt (15 µm) mit Stahlrohrbeine, Ø 30 mm, verchromt

6. GLEITER:

- Polypropylen Gleiter - on Polyamid



Forma

Visitor

Fissa, imbottita, struttura in metallo.
Schienale medio.Visitor, upholstered, metal structure.
Medium backrestVisiteur, rembourré, structure en métal.
Dossier moyen.Besucher, gepolstert, Metallgestell.
Mittlere Rückenlehne.

versions

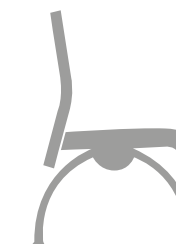
Forma
VisitorForma
Bench

64,2%

EN
1335EN
1022D.Lgs
81EN
1728EN
16139UNI
EN91755
YEAR
WARRANTY

AttivaC

design: Ambostudio

ATTIVA è una famiglia di sedute direzionali ed operative molto innovative e di alto livello qualitativo. Le finiture cromate lucide, la rete elastica dello schienale e l'innovativo sistema di molle protette all'interno del sedile creano una simbiosi di comfort ed eleganza. Il design è molto accattivante, si caratterizza per le sue linee forti e decise. È disponibile con due tipologie di schienale alto oppure basso, e due tipologie di braccioli.

ATTIVA is a family of very innovative directional office chairs and high standard. The polished chrome finish, the elastic mesh backrest and the innovative spring system protected inside the seat create a symbiosis of comfort and elegance. The design is very attractive, characterized by its strong and decisive lines. It's provided with high or low backrest, and two types of armrests.

ATTIVA est une famille de fauteuils opératifs et de direction de haut niveau et design. Les finitions chromées brillantes, la maille élastique du dossier et le système de ressorts "protégés" à l'intérieur de l'assise créent une symbiose de confort et élégance. Le design est captivant, caractérisé par des lignes fortes et attractives. Attiva est disponible avec dossier haut ou bas, et avec deux types d'accoudoirs.

ATTIVA ist eine innovative und hochwertige Drehstuhlfamilie geeignet im Direktionsbereich und Sekretariat. Die verchromte und glänzende Feinbearbeitungen, das elastische Netz der Rücklehne und das innovative Federungssystem im Sitz eingebaut erlauben eine lineare und einnehmende Symbiose zwischen Komfort und Eleganz. Das Design ist sehr attraktiv und kennzeichnet sich durch starke und klare Linien. Verfügbar mit hohe oder niedrige Rücklehne und mit zwei verschiedene Armlehnen.



AttivaC

MOVING



AttivaC

Girevole, schienale in rete,
traverso "C", molle sedile.
Schienale medio o alto.

Swivel, "C" bar, mesh
backrest, seat springs.
Medium or high backrest.

Pivotant, traverse "C",
dossier en résille, ressorts assise.
Moyen ou haut dossier.

Drehbar, Querstange "C", Netz
Rückenlehne, Federkern im Sitz.
Mittlere oder hohe Rückenlehne.

versions

AttivaC
Headrest



AttivaC
High



AttivaC
Medium



126 TOP

AttivaC
Headrest



TOP 127

AttivaC
Headrest



AttivaC
High



AttivaC
High



AttivaC
High



AttivaC
High





Attiva
Medium

Poland



AttivaC

AttivaC
Medium



AttivaC
Medium





technical data

mechanism

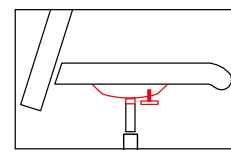

Piastra
Seat plate
Platine
Sitzplatte

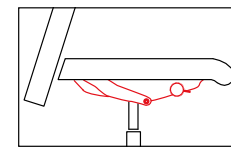

Meccanismo SynchroPlus+ con traslazione sedile
SynchroPlus+ mechanism with sliding seat device
Mécanisme SynchroPlus+ avec translation d'assise
SynchroPlus+ Mechanik mit Schiebesitz

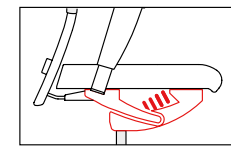

Meccanismo SynchroTeK nero
con traslazione sedile, inclinazione negativa
Black SynchroTeK mechanism
with sliding seat device, negative angle adj
Mécanisme SynchroTeK noir
avec translation et réglage négatif d'assise
Schwarze SynchroTeK Mechanik
mit Schiebe- und Sitzneigung

base



Base 5 razze in alluminio lucida
5-spoke polished aluminium base
Pièr. 5 branches alu poli
5-Stern Alu poliertes Fußkreuz



Base 5 razze in ferro cromata
5-spoke chromed iron base
Pièr. 5 branches en métal chromé
5-Stern verchromtes Eisen Fußkreuz



Base a 4 razze in alluminio lucida
Polished aluminium 4 spoke base
Piètement 4 branches alu poli
Alu poliertes 4-Fußkreuz

castors/feet

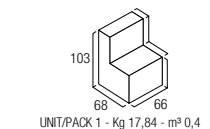
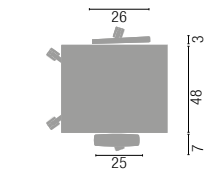
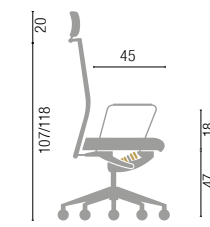
backrest
Headrest

UNIT/PAK 1 - Kg 17,84 - m³ 0,4

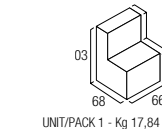
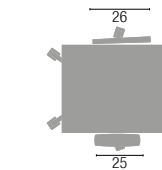
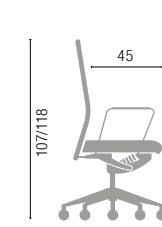
backrest
High

UNIT/PAK 1 - Kg 17,84 - m³ 0,4

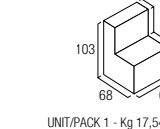
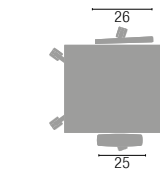
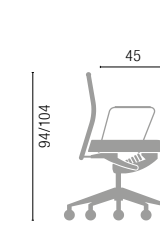
backrest
Medium

UNIT/PAK 1 - Kg 17,54 - m³ 0,4



wellness and comfort

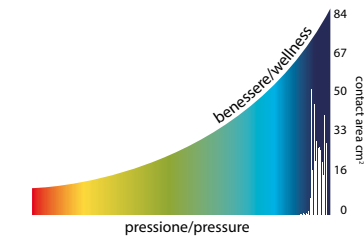

A Pressione sullo schienale di spalle e scapole
Shoulders and scapulas pressure on backrest
Pression des épaules et omoplates sur le dossier
Druck von der Schulter und Schulterblatt auf der Rückenlehne

B Pressione dell'area sacrale su supporto lombare
Sacrum pressure on lumbar support

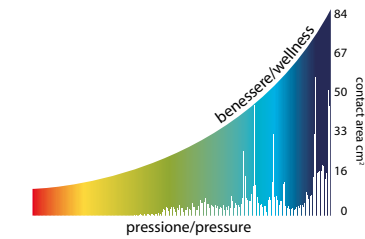

C Pressione di bacino e cosce sul sedile
Hip and thigh pressure on seat
Pression des cuisses et du bassin sur l'assise
Druck im Becken und Oberschenkel auf dem Sitz

1. SCHIENALE:

Schienale in tubo sagomato d'acciaio, Ø 25mm, finitura cromata rivestita (15µm) in rete o imbottita con spugna e rivestita in tessuto

2. SEDILE:

Sedile in polipropilene imbottito con spugna schiumata a freddo, rivestita in tessuto

3. MECCANISMO:

- SynchroTeK cromato o nero, comando elevazione a gas, regolazione tensione schienale: inclinazione 26°sch. 10,5°sed. in 5 posizioni con antishock, inclinazione negativa sed. 4,5° traslazione sed. 6cm in 5 posizioni
- SynchroPlus+, comando elevazione a gas, regolazione tensione schienale, inclinazione 20°sch. 8°sed. in 5 posizioni con antishock, traslazione sed. 6cm in 5 posizioni
- Comando elevazione a gas, finitura nera

4. GAS:

- Regolabile in altezza, rotazione, finitura cromata
- Regolabile in altezza, rotazione, finitura cromata, molleggio
- Altezza fissa, ritorno automatico, finitura cromata

5. BASE:

- Base 5 razze in alluminio, Ø 710mm, finitura lucida
- Base 5 razze in ferro, Ø 710mm, finitura cromata (15µm)
- Base 4 razze in alluminio, Ø 630mm, finitura lucida

6. RUOTE/PIEDINI:

- Ø 65mm, gommato o autofrenanti e gommato, finitura nera.
- Ruote Ø 50mm, autofrenanti o autofrenanti e gommato, finitura cromata
- Piedini in polimero termoplastico, h. 68mm, finitura cromata (15µm)
- Piedini in polimero termoplastico, h. 25mm, finitura cromata (15µm)

7. BRACCIOLI:

- Bracciolo fisso in piatto d'acciaio, 30x5mm, finitura cromata (15µm) (rivestito in tessuto)
- Bracciolo regolabile in tubo ellittico d'acciaio, 40x20mm, finitura cromata (15µm) o verniciata a polveri, con top in poliuretano morbido
- Bracciolo regolabile in 4D in tubo ovale d'acciaio, 45x25mm, finitura cromata, con top in poliuretano morbido
- Bracciolo regolabile in poliamide, finitura nera, con top in poliamide, finitura nera, o top in poliuretano morbido

1. BACKREST:

Ø25mm shaped steel tube backrest, chromed finish (15µm), mesh upholstered or foam padded and fabric upholstery

2. SEAT:

Polypropylene seat, cold injected foam padded, fabric upholstery

3. MECHANISM:

- Chromed or black SynchroTeK, gas lift height adj. Backrest tension adj. Backrest inclination: 26° in 5 positions with antishock; Seat inclination: 10,5°. Negative seat inclination: 4,5°. Sliding seat device 6cm in 5 positions
- SynchroPlus+, gas lift height adj. Backrest tension adj. backrest inclination 20° in 5 locking position with antishock, seat inclination 8°. Sliding seat device 6cm in 5 positions

4. GAS LIFT:

- Height adjustable, swivel, chromed finish
- Height adjustable, swivel, chromed finish, shock absorber springs
- Not height adjustable, memory return cylinder, chromed finish

5. BASE:

- Polished aluminium 5 spoke base, Ø 710 mm
- Iron 5 spoke base, Ø 710 mm chromed finish (15µm)
- Polished aluminium 4 spoke base, Ø 630 mm

6. CASTORS/FEET:

- Ø 65mm self-braking castors, or soft self-braking. Black finish
- Ø 50 mm self-braking castors, or soft self-braking. Chromed finish
- h. 68mm Thermoplastic polymer gliders chromed finish (15µm)
- h. 25mm Thermoplastic polymer gliders chromed finish (15µm)

7. ARMREST:

- Steel plate fixed armrest, 30x5mm, chromed finish (15µm), upholstered
- Height adj. Armrest, Ellipt. Steel tube 40x20mm, chromed finish (15µm) or powder coated, polyamide pad, black finish or soft polyurethane pad.
- 4D ADJ. ARMREST, in oval steel tube 45x25mm, chromed finish, soft polyurethane pad
- Black Polyamide adj. armrest, black polyamide top or soft black polyurethane pad

1. DOSSIER:

Dossier en tube d'acier formé, Ø 25mm, finition chromé (15µm), revêtu en résille ou rembourrée de mousse et tapissée

2. ASSISE:

Assise en polypropylène rembourrée de mousse moulée à froids, tapissée

3. MECANISME:

- SynchroTeK chromé ou noir, réglage en hauteur, réglage de tension, inclinaison dossier 26° et assise 10,5°, en 5 positions avec système antichoc, inclinaison négative assise 4,5°, profondeur d'assise 6 cm en 5 positions
- Réglable en hauteur, finition noir
- SynchroPlus+, réglage en hauteur, réglage de tension, inclinaison dossier 20° et assise 8°, en 5 positions avec système anti-choc, profondeur d'assise 6 cm en 5 positions

4. VERIN A GAS:

- Réglable en hauteur, pivotant, finition chromé
- Réglable en hauteur, pivotant, finition chromé, amortisseur
- Hauteur fixe, retour automatique, finition chromé

5. PIÈTEMENT:

- Piètement 5 branches alu poli, Ø 710mm
- Piètement 5 branches en métal, Ø 710mm, finition chromé (15µm)
- Piètement 4 branches alu poli, Ø 630mm

6. ROULETTES/PATINS:

- Roulettes Ø 65mm, gommées ou autofreinantes et gommées, finition noir
- Roulettes Ø 50mm, autofreinantes ou autofreinantes et gommées, finition chromé
- Patins en polymère thermoplastique, h. 68mm, finition chromée (15µm)
- Patins polymère thermoplastique, h. 25mm, finition chromée (15µm)

7. ACCUDOIR:

- Accoudoir fixe plat en acier, 30x5mm, finition chromé (15µm) (tapissé)
- Accoudoir réglable en tube d'acier elliptique, 40x20mm, finition chromé (15µm) ou verni époxy, manchette en polyamide, finition noir ou en polyuréthane souple
- Accoudoir réglable en 4D en tube ovale d'acier, 45x25mm, finition chromé, manchette en polyuréthane souple
- Accoudoir réglable en polyamide, finition noir, manchette en polyamide, finition noir ou en polyuréthane souple

1. RÜCKENLEHNE:

Ø25mm Geformte Stahlrohr Rückenlehne-verchromt (15µm), Netz gepolstert oder kaltgeschäumten Polyurethan mit Stoffbezug

2. SITZ:

Polypropylen Sitz, ausgepolstert mit kaltgeschäumten Polyurethan, mit Stoffbezug

3. MECHANIK:

- SynchroTeK verchromt oder schwarz, Gaslift Höhenverstellung, Rückenlehne mit Spannungsregler, 26° Rückenlehneineigung, 10,5° Sitzneigung, negative Sitzneigung 4,5°, 5-stufige Einstellung mit Antishock, 6 cm Sitztiefenverstellung mit 5 Positionen
- Schwarze Sitzhöhenverstellung
- SynchroPlus+, Gaslift Höhenverstellung, Rückenlehne mit Spannungsregler, 20° Rückenlehneineigung, 8° Sitzneigung, 5-stufige Einstellung mit Antishock, 6 cm Sitztiefenverstellung mit 5 Positionen

4. GASFEDER:

- Piètenverstellung, drehbar, verchromt
- Sitzhöhenverstellung, drehbar, verchromt, mit Stoßdämpfende Feder
- Rückholmechanik ohne Sitzhöhenverstellung, verchromt

5. GESTELL:

- 5-Stern Alu poliertes Fußkreuz, Ø 710 mm
- 5-Stern Eisen Fußkreuz, Ø 710mm verchromt (15µm)
- 4-Stern Alu poliertes Fußkreuz, Ø 630 mm

6. ROLLEN/GLEITER:

- Ø 65 mm gebremste, oder weiche gebremste Rollen, schwarze gebremste Rollen, verchromt
- Thermoplastische Polymergleiter, H. 68 mm, verchromt (15µm)
- Thermoplastische Polymergleiter, H. 25mm, verchromt (15µm)

7. ARMLEHNEN

- Feste Armlehne aus Flachstahl 30x5 mm, verchromt (15µm) (Stoff gepolstert)
- Verstellbare Armlehne aus Ellipt. Stahlrohr, 40x20mm, verchromt (15µm) oder pulverbeschichtet, schwarze Polyamid Armauflage oder weichen Polyurethan
- 4D verstellbare Armlehne aus ovales Stahlrohr, 45x25mm, verchromt (15µm) schwarze Polyamid weiche Armauflage
- Verstellbare schwarze Polyamid Armlehne mit Polyamid Armauflage oder mit weiche Polyurethan Armauflage



EN 1335

EN 1022

D.Lgs 81

EN 1728

EN 16139

EN 9175

5 YEAR WARRANTY

CE



ID 1111209619



AttivaC

options

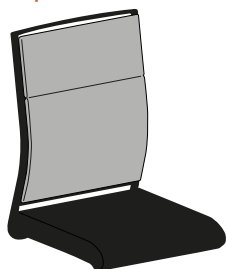

XC012 - high cushion

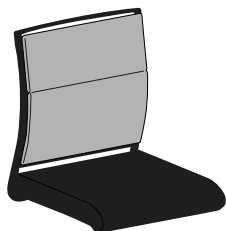

XC013 - medium cushion

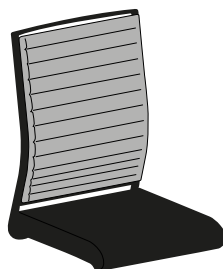

XC020 - high cushion

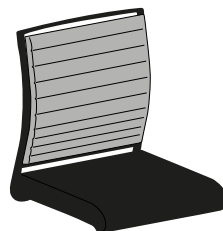

XC021 - medium cushion

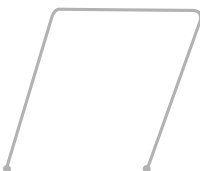

XB001 - metal arm.



XB002 - metal arm.
uph. pad

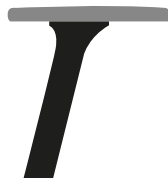

XB024 - chromed
4D soft pad

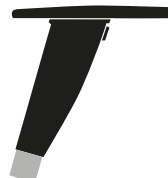

XB082 - chromed 3D

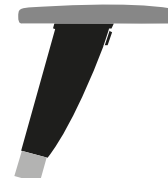

XB084 - chromed
3D soft pad

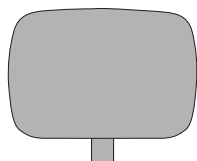

headrest
XT001



lumbar support
XR001 - beige
XR006 - black

Crono

design: AZ Creations



CRONO è una famiglia di sedute direzionali e semi-direzionali personalizzabile in ogni dettaglio. È una seduta che trasmette un'immagine di solidità e comfort allo stesso tempo, vincitrice del primo premio COMFORT SEATING 2011 nella sua categoria. Nella versione più accessoriata è provvista di schienale imbottito, poggiatesta e braccioli regolabili multidirezionali. La speciale manopola sul retro dello schienale permette una facile regolazione di quest'ultimo in modo da adattare l'altezza del supporto lombare alle specifiche esigenze.

CRONO is a family of executive and semi-directional chairs that can be customized in each detail. It is a seating that conveys an image of strength and comfort at the same time, winner of the first prize COMFORT SEATING 2011 in its category. The fully equipped version with upholstered backrest, headrest and multi-adjustable armrests, to the minimalist version with mesh backrest, all characterized by clean and essential lines. The special handle on the back allows easy adjustment of the lumbar support according to the height of the end user.

CRONO est une famille de fauteuils de direction et semi-direction personnalisable dans chaque détail. C'est un siège qui transmet une image de robustesse et de confort au même temps ; il a remporté le premier prix COMFORT SEATING 2011 dans sa catégorie. Dans la version plus complète il est équipé de dossier rembourré, appuie-tête et accoudoirs multifonctions. La poignée sur le dossier permet un réglage facile de ce dernier afin de régler la hauteur du support lombaire selon les besoins de l'utilisateur.

CRONO ist eine Stuhlfamilie für Direktionsbereiche und sonstige Sekretariatsarbeiten, die in jedem Detail kundenspezifisch angepasst werden kann. Es handelt sich um einen Stuhl, der gleichzeitig ein solides und komfortables Aussehen überträgt. Crono wurde „COMFORT SEATING“ Preissieger in seiner Kategorie im Jahre 2011. Die meist ausgestattete Version ist mit gepolsterter Rückenlehne, verstellbare Kopfstütze und verstellbare Armlehnen. Der besondere Handgriff auf der Rückseite der Rücklehne ermöglicht eine einfache Höhenverstellung der Rückenlehne um die Lumbalstütze anzupassen.

Crono



Crono

Girevole, imbottita, schienale regolabile in altezza, supporto lombare.

Swivel, upholstered, adj. backrest, lumbar support.

Pivotant, rembourré, dossier régl. en hauteur, soutien lombaire.

Drehbar, gepolstert, höhenverst. Rückenl., Lumbalstütze.

versions

Crono
Headrest



Crono



Crono

Headrest



Crono

Headrest



Crono

Headrest



Crono

Headrest



Crono



Crono



TOP
collection

Crono

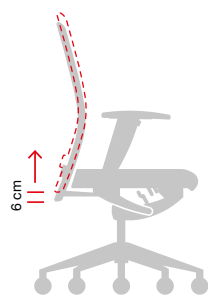

Schienale regolabile in altezza
Height adjustable backrest
Dossier réglable en hauteur
Höhenverst. schwarz

backrest Headrest

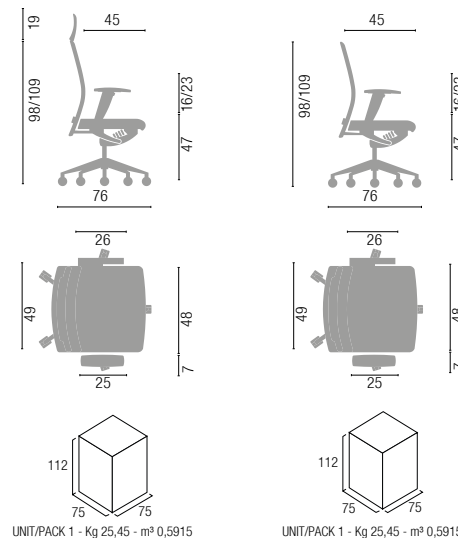

technical data

mechanism

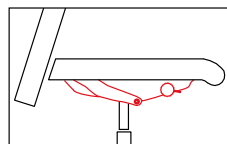

Meccanismo SynchroPlus+ con traslazione sedile
SynchroPlus+ mechanism with sliding seat device
Mécanisme SynchroPlus+ avec translation d'assise
SynchroPlus+ Mechanik mit Schiebesitz

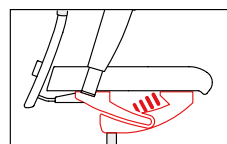

Meccanismo SynchroTeK nero con traslazione sedile, inclinazione negativa
Black SynchroTeK mechanism with sliding seat device, negative angle adj.
Mécanisme SynchroTeK noir avec translation et réglage négatif d'assise
Schwarze SynchroTeK Mechanik mit Schiebe- und Sitzneigung

base



Base 5 razze in alluminio lucida
5-spoke polished aluminium base
Piè: 5 branches alu poli
5-Stern Alu poliertes Fußkreuz



base 5 razze poliamide nera
5-spoke black polyamide base
piè: 5 branches polyamide noir
5-Stern schwarzes Polyamid Fußkreuz

castors



options

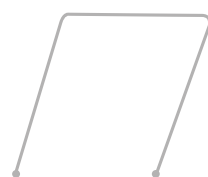

XB001 - metal arm.



XB002 - metal arm.
uph. pad



XB024 - chromed
4D soft pad



XB082 - chromed 3D



XB084 - chromed
3D soft pad



headrest
XT002



XD001 - seat with
springs

Crono

**1. SCHIENALE:**

Schienale regolabile in altezza (6cm) in spugna schiumata a freddo con struttura portante in tubo tondo d'acciaio, Ø 20mm, rivestita in tessuto

2. SEDILE:

Sedile in polipropilene imbottito con spugna schiumata a freddo, rivestita in tessuto

3. MECCANISMO:

SynchroPlus+, comando elevazione a gas, regolazione tensione schienale, inclinazione 20°sch. 8°sed. in 5 posizioni con antishock, traslazione sed. 6cm in 5 posizioni.

SynchroTeK cromato o nero, comando elevazione a gas, regolazione tensione schienale: inclinazione 26°sch.

10.5°sed. in 5 posizioni con antishock, inclinazione negativa sed. 4,5° traslazione sed. 6cm in 5 posizioni

4. GAS:

Regolabile in altezza, rotazione, finitura cromata

Regolabile in altezza, rotazione, finitura nera

Regolabile in altezza, rotazione, finitura cromata, molleggio

5. BASE:

5 razze in alluminio, Ø 710mm, finitura lucida.

Base 5 razze in poliamide con carica di fibra di vetro, Ø 680mm, finitura nero

6. RUOTE:

Ø 65mm, gommate o autofrenanti e gommate, finitura nera.

Ø 50mm, autofrenanti o autofrenanti e gommate, finitura nera

Piedini in polimero termoplastico, h. 68mm, finitura cromata (15µm)

Piedini in poliamide, h. 61mm, finitura nera

7. BRACCIOLI:

Bracciolo regolabile in tubo ellittico d'acciaio, 40x20mm, finitura cromata (15µm) o verniciata a polveri, con top in poliamide, finitura nera, o top in poliuretano morbido

Bracciolo regolabile in 4D in tubo ovale d'acciaio, 45x25mm, finitura cromata, con top in poliuretano morbido

Bracciolo fisso in piatto d'acciaio, 30x5mm, finitura cromata (15µm) (rivestito in tessuto)

1. BACKREST:

Height adjustable backrest (6cm) Cold injected foam padding monocoque, Ø 20mm steel tube structure, fabric upholstery

2. SEAT: Polypropylene seat, cold injected foam padded, fabric upholstery

3. MECHANISM:

Chromed or black SynchroTeK, gas lift height adj. Backrest tension adj. Backrest inclination: 26° in 5 positions with antishock; Seat inclination: 10.5°.

Negative seat inclination: 4.5°. Sliding seat device 6cm in 5 positions

SynchroPlus+, gas lift height adj. Backrest tension adj. backrest inclination 20° in 5 locking position with antishock, seat inclination 8°.

Sliding seat device 6cm in 5 positions

4. GAS LIFT:

Height adjustable, swivel, chromed finish

Height adjustable, swivel, Black finish

Height adjustable, swivel, chromed finish, shock absorber springs

5. BASE:

Polished aluminium 5 spoke base, Ø 710 mm

Fiberglass reinforced polyamide 5 spoke base, Ø 680 mm, black finish

6. CASTORS:

Ø 65mm self-braking castors, or soft self-bracking. Black finish

Ø 50 mm self-braking castors, or soft self-bracking. Black finish

h. 68mm Thermoplastic polymer gliders chromed finish (15µm)

h. 61 mm polyamide glides, black finish

7. ARMREST:

Height adj. Armrest, Ellipt. Steel tube 40x20mm, chromed finish (15µm) or powder coated, polyamide pad, black finish or soft polyuretane pad.

4D ADJ. ARMREST, in oval steel tube 45x25mm, chromed finish, soft polyuretane pad

teel plate fixed armrest, 30x5mm, chromed finish (15µm), upholstered

welfare and comfort

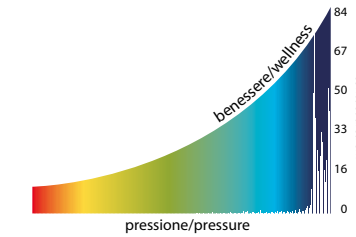

A Pressione sullo schienale di spalle e scapole
Shoulders and scapulas pressure on backrest
Pression des épaules et omoplates sur le dossier
Druck von der Schulter und Schulterblatt auf der Rückenlehne

B Pressione dell'area sacrale su supporto lombare
Sacrum pressure on lumbar support

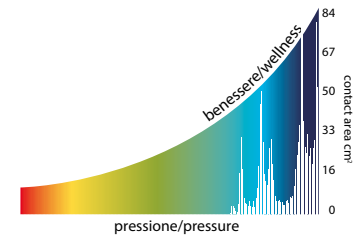

Pression sacrale sur le soutien lombaire
Druck im Bereich heiliger Knochen und Lendenwirbelstütze

C Pressione di bacino e cosce sul sedile
Hip and thigh pressure on seat
Pression des cuisses et du bassin sur l'assise
Druck im Becken und Oberschenkel auf dem Sitz



ID 1111209675



TOP
collection

Giada

design: AZ Creations

GIADA è una collezione di sedute tecnologiche direzionali e semi-direzionali. Il robusto schienale in poliuretano e il sedile sagomato creano un'immagine maestosa, ma allo stesso tempo capace di adattarsi a diversi tipi di ambiente. È disponibile con schienale basso oppure alto e il meccanismo SynchroPlus+.

GIADA is a collection of technological executive chairs. The solid polyurethane backrest and the ergonomical shaped seat create an image of majesty, but it is also able to adapt to different environments. It is available with low or high backrest, the SynchroPlus+ mechanism.

GIADA est une collection de fauteuils technologiques de direction et semi-direction. Le robuste dossier en polyuréthane et l'assise ergonomique créent une image majestueuse et autant capable de s'adapter à différents environnements. Il est disponible avec dossier bas ou haut et équipé de mécanisme SynchroPlus+.

GIADA ist eine technologische Stuhlfamilie für Direktionsbereiche und die Geschäftsleitungen. Die starke Rücklehne aus kaltgeschäumten Polyurethan und die ergonomische Sitzfläche wirken Majestätisch. Gleichzeitig aber zu verschiedenen Bereiche geeignet. Verfügbar mit hohe oder niedrige Rücklehne und SynchroPlus+ Mechanik.

TOP 155



Giada



Giada

Girevole, imbottita.
Schienale medio o alto.

Swivel, upholstered.
Medium or high backrest.

Pivotant, rembourré.
Moyen ou haut dossier.

Drehbar, gepolstert.
Mittlere oder hohe Rückenlehne.



versions

Giada
Headrest

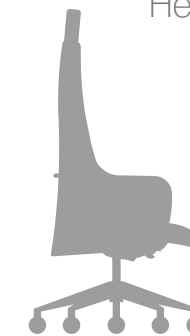

Giada
High



Giada
Medium



158 TOP



Giada
Medium

TOP 159



Giada
Medium

Giada
High



TOP 161

TOP
collection

Giada

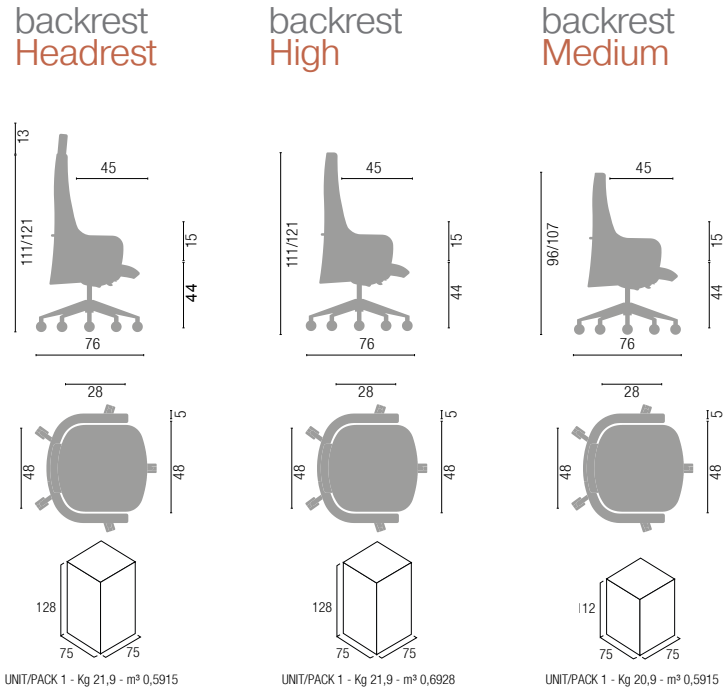

technical data

mechanism

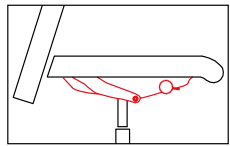

Meccanismo SynchroPlus+
SynchroPlus+ mechanism
Mécanisme SynchroPlus+
SynchroPlus+ Mechanik

base



Base 5 razze in alluminio lucida
5-spoke polished aluminium base
Piët. 5 branches alu poli
5-Stern Alu poliertes Fußkreuz



Base 5 razze in ferro cromata
5-spoke chromed iron base
Piët. 5 branches en métal chromé
5-Stern verchromtes Eisen Fußkreuz

castors



options

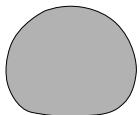

headrest
XT005

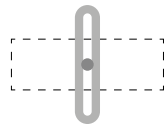

lumbar support
XR004 - high backrest
XR005 - medium backrest

Giada



A Pressione sullo schienale di spalle e scapole
Shoulders and scapulas pressure on backrest
Pression des épaules et omoplates sur le dossier
Druck von der Schulter und Schulterblatt auf der Rückenlehne

B Pressione dell'area sacrale su supporto lombare
Sacrum pressure on lumbar support

C Pressione di bacino e cosce sul sedile
Hip and thigh pressure on seat
Pression des cuisses et du bassin sur l'assise
Druck im Becken und Oberschenkel auf dem Sitz

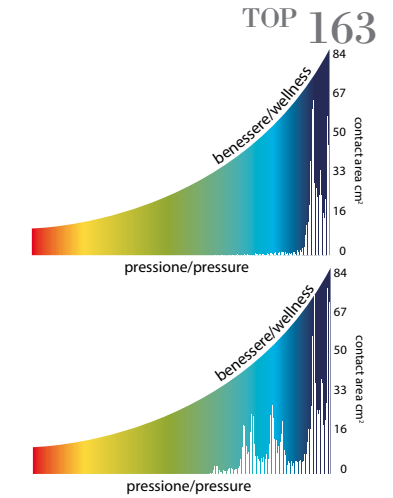

1. SCHIENALE:

Schienale in spugna schiumata a freddo con struttura portante in tubo tondo d'acciaio, Ø 16mm, rivestita in tessuto (poggiareni in poliamide integrato nello schienale)

2. SEDILE:

Sedile in polipropilene imbottito con spugna schiumata a freddo, rivestita in tessuto

3. MECCANISMO:

- SynchroPlus+, comando elevazione a gas, regolazione tensione schienale, inclinazione 20°sch. 8°sed. in 5 posizioni con antishock, traslazione sed. 6cm in 5 posizioni.

4. GAS:

- Regolabile in altezza, rotazione, finitura cromata, molleggio

5. BASE:

- 5 razze in alluminio, Ø 710mm, finitura lucida.
- 5 razze in ferro, Ø 710mm, finitura cromata (15µm).

6. RUOTE:

- Ø 65mm, gommata o autofrenanti e gommata, finitura nera.
- Ø 50mm, autofrenanti o autofrenanti e gommata, finitura cromata

1. BACKREST:

Ø25mm shaped steel tube backrest, chromed finish (15µm), mesh upholstered or foam padded and fabric upholstery (padded polyamide lumbar support, fabric upholstery)

2. SEAT:

Polypropylene seat, cold injected foam padded, fabric upholstery

3. MECHANISM:

- SynchroPlus+, gas lift height adj. Backrest tension adj. backrest inclination 20° in 5 locking position with antishock, seat inclination 8°. Sliding seat device 6cm in 5 positions

4. GAS LIFT:

- Height adjustable, swivel, chromed finish, shock absorber springs

5. BASE:

- Polished aluminium 5 spoke base, Ø 710 mm
- Iron 5 spoke base, Ø 710 mm chromed finish (15µm)

6. CASTORS:

- Ø 65mm self-braking castors, or soft self-braking. Black finish
- Ø 50 mm self-braking castors, or soft self-braking. Chromed finish

1. DOSSIER:

Dossier en mousse moulée à froids avec châssis en tube d'acier rond, Ø 16mm, tapissé. Soutien lombaire intégré

2. ASSISE:

Assise en polypropylène rembourrée de mousse moulée à froids, tapissée

3. MECANISME:

- SynchroPlus+, réglage en hauteur, réglage de tension, inclinaison dossier 20° et assise 8°, en 5 positions avec système anti-choc, profondeur d'assise 6 cm en 5 positions

4. VERIN A GAZ:

- Réglable en hauteur, pivotant, finition chromé, amortisseur

5. PIETEMENT:

- Piètement 5 branches alu poli, Ø 710mm
- Piètement 5 branches en métal, Ø 710mm, finition chromé (15µm)

6. ROULETTES:

- Roulettes Ø 65mm, gommées ou autofreinantes et gommées, finition noir
- Roulettes Ø 50mm, autofreinantes ou autofreinantes et gommées, finition chromé

1. RÜCKENLEHNE:

Kaltgeschäumten Polyurethan, mit Stoffbezug. Ø 16mm Stahlrohrschale (Integrierte ausgepolsterte Polyamid Lumbarstütze mit Stoffbezug)

2. SITZ:

Polypropylen Sitz, ausgepolstert mit Kaltgeschäumten Polyurethan, mit Stoffbezug

3. MECHANIK:

- SynchroPlus+, Gaslift Höhenverstellung, Rückenlehne mit Spannungsregler, 20° Rückenlehneigung, 8° Sitzneigung, 5-stufige Einstellung mit Antishock, 6 cm Sitztiefenverstellung mit 5 Positionen

4. GASFEDER:

- Sitzhöhenverstellung, drehbar, verchromt, mit Stoßdämpfende Feder

5. GESTELL:

- 5-Stern Alu poliertes Fußkreuz, Ø 710 mm
- 5-Stern Eisen Fußkreuz, Ø 710mm verchromt (15µm)

6. ROLLEN:

- Ø 65 mm gebremste, oder weiche gebremste Rollen, schwarze
- Ø 50 mm gebremste, oder weiche gebremste Rollen, verchromt



Aurelia

design: AZ Creations

AURELIA è una famiglia di poltrone direzionali. Maestosa nel nome, importante nella figura: linee pulite e minuziosa nei dettagli, è una seduta che non lascia nulla al caso. Le caratteristiche principali di questa linea sono la monoscocca realizzata in poliuretano espanso; la forma solida, le finiture cromate e le particolari cuciture centrali le danno un valore aggiunto. La serie AURELIA è disponibile con schienale alto oppure basso e girevole oppure fissa su base a slitta.

AURELIA is a family of executive armchairs. Majestic in the name, important in the shape: with clean lines and meticulous attention to details, this chair does not leave anything to chance. The main features of this line are the monocoque made of polyurethane foam, the solid form, the chrome finish and the central stitching details which give it an added value. AURELIA collection is available with low or high backrest, swivel or fixed version on a cantilever base.

AURELIA est une famille de fauteuils de direction. Majestueuse dans son nom, importante dans sa forme : les lignes épurées et les détails minutieux ; c'est un fauteuil qui ne laisse rien au hasard. Les principales caractéristiques de cette collection sont le monocoque en mousse de polyuréthane, la forme solide, les finitions chromées et les spéciales piqûres centrales qui lui donnent une valeur ajoutée. La série AURELIA est disponible en dossier bas ou haut, en version pivotante ou fixe luge.

AURELIA A ist eine klassische Stuhlfamilie für den Direktionsbereich. Ein Majestätischen Namen mit einer wichtige Figur. Die Saubere Linien und die Liebe zu den Details die nichts dem Zufall überlassen. Die wichtigste Merkmale dieses Modell sind; eine einzige Sitzschale aus kaltgeschämten Polyurethan, eine Solide Form, verchromte Feinbearbeitungen und besondere Nähte, auch sichtbare, bieten einen gewissen Mehrwert an. Die Aurelia Stuhlfamilie ist in folgende Version zu haben; drehbar mit hohe oder mittlere Rückenlehne, oder mit Freischwinger Gestell.





Aurelia

Girevole, scocca in poliuretano, struttura in metallo. Schienale medio o alto.

Swivel, polyuretane shell, metal structure. Medium or high backrest.

Pivotant, coque en polyuréthane, structure en métal. Moyen ou haut dossier.

Drehbar, Polyurethanschale, Metallgestell. Mittlere oder hohe Rückenlehne.



versions

Aurelia
High



Aurelia
Medium



Aurelia
Ducale - High



Aurelia
Imperiale, Ducale, Regale - High

Aurelia
Ducale - Medium



Aurelia
Imperiale - Medium



TOP
collection

Aurelia

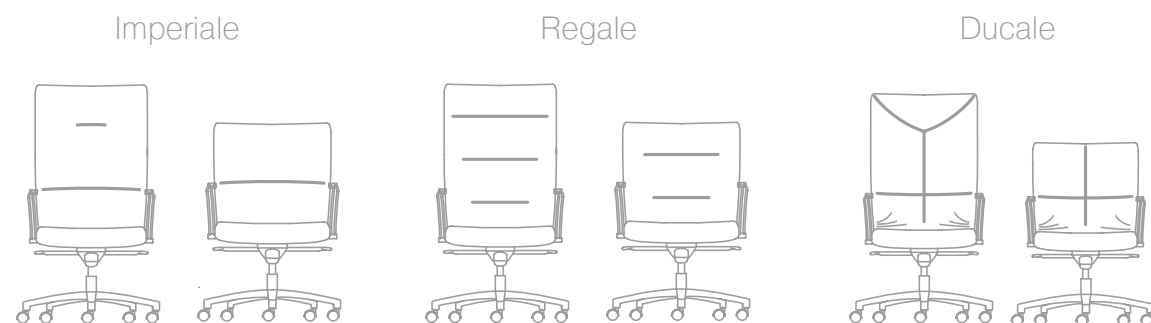

technical data

mechanism

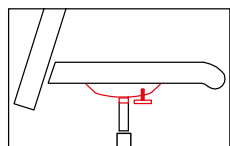

Piastra
Seat plate
Platine
Sitzplatte

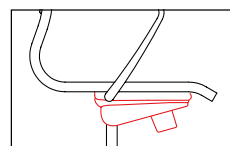

Meccanismo oscillante
Tilting mechanism
Mécanisme basculant
Wippmechanik

base



Base 5 razze in alluminio lucida
5-spoke polished aluminium base
Pièd. 5 branches alu poli
5-Stern Alu poliertes Fußkreuz

castors

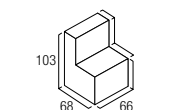
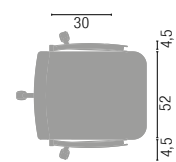
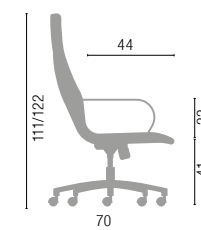
backrest
High

UNIT/PACK 1 - Kg 16,14 - m³ 0,4

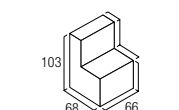
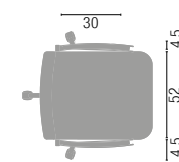
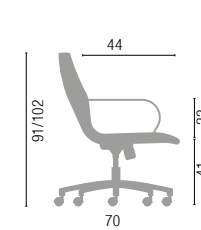
backrest
Medium

UNIT/PACK 1 - Kg 15,34 - m³ 0,4

**1. SCHIENALE:**

Monoscocca in spugna schiumata a freddo con struttura portante in tubo tondo d'acciaio, Ø 20mm, rivestita in tessuto

2. MECCANISMO:

- Oscillante nero, comando elevazione a gas, regolazione tensione schienale
- Comando elevazione a gas, finitura nera

3. GAS:

Regolabile in altezza, rotazione, finitura cromata

4. BASE:

5 razze in alluminio, Ø 710mm, finitura lucida.

5. RUOTE:

Ø 50mm, autofrenanti o autofrenanti e gommate, finitura nera

6. BRACCIOLO:

Bracciolo fisso in tondo d'acciaio, Ø 12mm, finitura cromata (15µm) con inserto in poliuretano morbido (rivestito in tessuto)

1. BACKREST:

Cold injected foam padding monocoque, Ø 20mm steel tube structure, fabric upholstery

2. MECHANISM:

- Black tilting, gas lift height adj. Backrest tension adjustment.
- Height adjustable, Black finish

3. GAS LIFT:

Height adjustable, swivel, chromed finish

4. BASE:

Polished aluminium 5 spoke base, Ø 710 mm

5. CASTORS:

Ø 50 mm self-braking castors, or soft self-bracking. Black or Chromed finish

6. ARMREST:

Steel round bar fixed armrest, Ø 12mm, - chromed finish (15µm) soft polyurethane insert (upholstered)

1. DOSSIER:

Monocoque en mousse moulée à froids avec châssis en tube d'acier rond, Ø 20mm, tapissée

2. MECANISME:

- Basculant noir, réglage en hauteur, réglage de tension
- Réglable en hauteur, finition noir

3. VERIN A GAZ:

Réglable en hauteur, pivotant, finition chromé

4. PIETEMENT:

Piètement 5 branches alu poli, Ø 710mm

5. ROULETTES:

Roulettes Ø 50mm, autofreinantes ou autofreinantes et gommées, finition noir

6. ACCOUDOIR:

Accoudoir fixe en tige d'acier, Ø 12mm, finition chromé (15µm) avec manchette en polyuréthane souple (tapissé)

1. RÜCKENLEHNE:

Kaltgeschäumten Polyurethan Schale mit Stoffbezug. Ø20mm Stahlrohrschale

2. MECHANIK:

- Schwarze Wippmechanik, Gaslift Höhenverstellung, Rückenlehne Spannungsregler
- Schwarze Sitzhöhenverstellung

3. GASFEDER:

Sitzhöhenverstellung, drehbar, verchromt

4. GESTELL:

5-Stern Alu poliertes Fußkreuz, Ø 710 mm

5. ROLLEN:

Ø 50 mm gebremste, oder weiche gebremste Rollen, schwarz

6. ARMLEHNE:

feste Armlehne aus Stahlstab Ø 12mm, verchromt (15µm), weiche Polyurethan Armauflage (Stoff Gepolstert)

options



XR067 - metal arm. black polyurethane pad
XR068 - metal arm. uph. pad



Certification and guarantee of absolute product quality

ICNet Certified Management System

ISO 9001:2008 Quality

ISO 14001:2004 Environmental

OHSAS 18001:2007 Safety



Aurelia

Ducale - Visitor



Aurelia

Visitor

Fissa, scocca in poliuretano,
struttura in metallo.

Visitor, polyuretane shell, metal
structure.

Visiteur, coque en polyurethane,
structure en metal.

Drehbar, Polyurethanschale,
Metallgestell.

versions

Aurelia
Visitor



Aurelia

Regale, Ducale - Visitor



TOP
collection

Aurelia

Visitor

Imperiale

Regale

Ducale

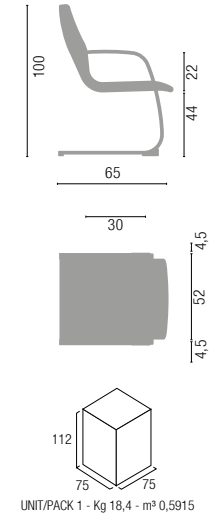
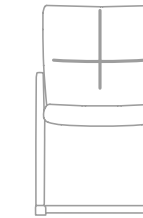
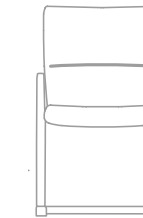

technical data

options



XH007 - uph. pad

base



Base a slitta cromata con braccioli
Chromed cantilever base with arms
Pièt. luge chromé avec accoudoirs
Freischwinger Gestell verch. mit Armf.

feet



SCHIENALE E SEDILE:

Monoscocca in spugna schiumata a freddo con struttura portante in tubo tondo d'acciaio, Ø 16mm, rivestita in tessuto

BASE:

Base a slitta in tubo rettangolare d'acciaio, 40x20mm, finitura cromata (15µm)

PIEDINI:

Tappi antiribaltamento in poliamide, finitura nera

BACKREST AND SEAT:

Cold injected foam padding monocoque, Ø 16mm steel tube structure, fabric upholstery

BASE:

Cantilever base, 40x20mm, rect. Steel tube, chromed finish (15µm)

FEET:

Polyamide anti overturning plugs, black finish

DOSSIER ET ASSISE:

Monocoque en mousse moulée à froids avec châssis en tube d'acier rond, Ø 16mm, tapissée

PIÈTEMENT:

Piètement luge en tube d'acier rectangulaire, 40x20mm, finition chromé (15µm)

PATINS:

Tampons anti renversement en polyamide, finition noir

RÜCKENLEHNE, SITZ:

Kaltgeschäumten Polyurethan Schale mit Stoffbezug. Ø20mm Stahlrohrschale

GESTELL:

Kufengestell, 40x20mm Vierkantstahlrohr, verchromt (15µm)

GLEITER:

Schwarze Polyamid antirollgleiter



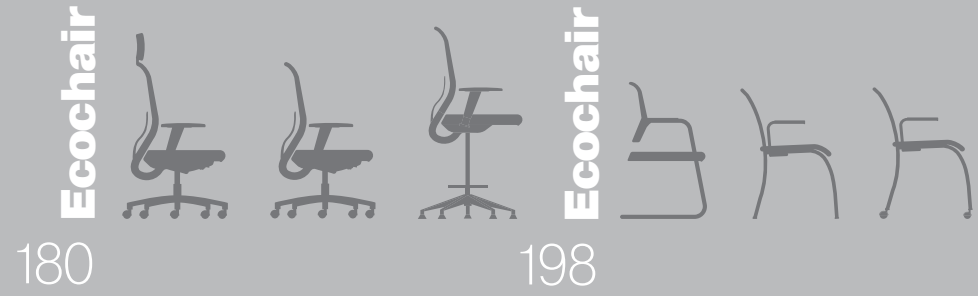

OPERATIVE
collection

Ecochair

design: AZ Creations

eco
ECOCHAIR
PATENT

ECOCHAIR è una famiglia di sedute operative all'avanguardia per tecnologia ed ergonomia. Questa seduta rientra inoltre nella tipologia A per quanto riguarda l'aspetto ergonomico e garantisce quindi un comfort ottimale ad ogni tipo di persona; grazie a materiali ecosostenibili ECO è amica dell'ambiente, è infatti riciclabile al 98,5%.

ECOCHAIR is a family of office chairs at the cutting edge of technology and ergonomics. This seating is also in type A with regard to ergonomics and this ensures optimum comfort for all types of people; thanks to its eco-friendly materials ECO is recyclable at 98.5%.

ECOCHAIR est une famille de sièges de bureau à l'avant-garde pour technologie et ergonomie. Ce siège fait également partie de la typologie A pour ce qui concerne l'ergonomie et ça garantit un confort optimal pour tout type de personnes ; grâce à ses matériaux respectueux de l'environnement ECOCHAIR est écologique et recyclable au 98.5%.

ECOCHAIR ist eine Stuhlfamilie welche zum Sekretariat geeignet ist für Technologie und Ergonomie. Diese Stuhlfamilie gehört durch sein ergonomisches Aussehen zu der Typologie A und garantiert einen optimalen Komfort für jeden Mensch. Dank der Verwendung von umweltfreundlichen Material ist ECOCHAIR zu 98,5% recycelbar.



Ecochair



Ecochair

Girevole, schienale in rete,
supporto lombare regolabile.

Swivel, mesh backrest, adj.
lumbar support.

Pivotant, dossier en
résille, soutien lombaire régl.

Drehbar, Netz Rückenlehne,
verstellbare Lumbalstütze.



versions



Ecochair

Headrest



Ecochair

Headrest



Ecochair

Headrest



Ecochair

Ecochair



Ecochair



Ecochair



Ecochair



Ecochair

Stool



Ecochair

Stool



Ecochair



technical data

mechanism

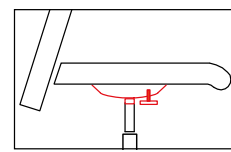

Piastra
Seat plate
Platine
Sitzplatte

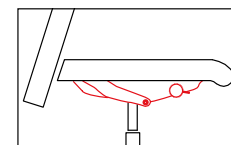

Meccanismo SynchroPlus+ con
traslazione sedile
SynchroPlus+ mechanism with sliding
seat device
SynchroPlus+ avec translation d'assise
SynchroPlus+ Mechanik mit Schiebesitz

base



Base 5 razze design poliamide nera
5-spoke black polyamide design base
Piët. design 5 branches polyam. noir
5-Stern schwarzes Polyamid Design Fußkreuz



Base 5 razze design poliamide nera o bianca
5-spoke black or white polyamide design base
Piët. design 5 branches polyam. noir ou blanc
5-Stern schwarzes oder weisses Polyamid Design Fußkreuz



Base 5 razze in alluminio lucida
5-spoke polished aluminium base
Piët. 5 branches alu poli
5-Stern Alu poliertes Fußkreuz

castors/feet



backrest Headrest

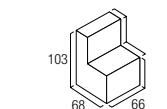
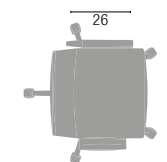
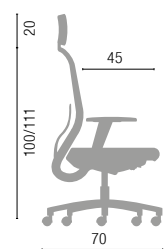

UNIT/PACK 1 - Kg 14,24 - m³ 0,4

backrest

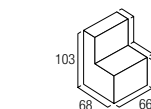
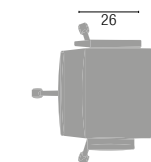
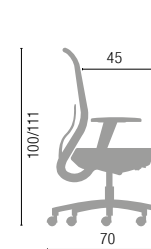

UNIT/PACK 1 - Kg 14,24 - m³ 0,4

stool

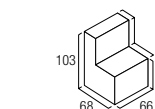
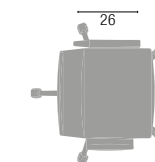

UNIT/PACK 1 - Kg 12,94 - m³ 0,4



Ecochair

1. SCHIENALE:

Schienale in poliamide con carica di fibra di vetro, finitura nera, rivestito in rete, con poggiatesta integrato

2. SEDILE:

Sedile in polipropilene imbottito con spugna schiumata a freddo, rivestita in tessuto

3. MECCANISMO:

- Comando elevazione a gas, finitura nera
- SynchroPlus+, comando elevazione a gas, regolazione tensione schienale, inclinazione 20° sch. 8° sed. in 5 posizioni con antishock, traslazione sed. 6cm in 5 posizioni

4. GAS:

- Regolabile in altezza, rotazione, finitura cromata
- Regolabile in altezza, rotazione, finitura nera
- Regolabile in altezza, rotazione, finitura cromata, sgabello

5. BASE:

- Base 5 razze in poliamide con carica di fibra di vetro, Ø 700mm, finitura nero
- Base 5 razze in alluminio, Ø 700mm, finitura lucida
- Base 5 razze in poliamide con carica di fibra di vetro, Ø 680mm, finitura nero

6. RUOTE/PIEDINI:

- Ruote Ø 50mm, autofrenanti o gommate, finitura nera
- Piedini in polimero termoplastico, h. 68mm, finitura cromata (15µm)
- Piedini in poliamide, h. 61mm, finitura nera

7. BRACCIOLE:

- Bracciolo regolabile in altezza in tubo ellittico d'acciaio, 40x20mm, finitura cromata (15µm) verniciata a polveri, con top in poliamide, finitura nera (tavoletta in polipropilene)
- Bracciolo regolabile in tubo ellittico d'acciaio, 40x20mm, finitura cromata (15µm) o verniciata a polveri, con top in poliamide, finitura nera, o top in poliuretano morbido
- Bracciolo fisso in piatto d'acciaio, 30x5mm, finitura cromata (15µm)
- Bracciolo fisso in tubo tondo d'acciaio, Ø 16mm, finitura cromata (15µm) o verniciata a polveri, con top in poliamide, finitura nera
- Braccioli fissi poliamide

1. BACKREST:

Fiberglass reinforced polyamide backrest, black finish, upholstered in mesh, integrated lumbar support

2. SEAT:

Polypropylene seat, cold injected foam padded, fabric upholstery

3. MECHANISM:

- Height adjustable, Black finish
- SynchroPlus+, gas lift height adj. Backrest tension adj. backrest inclination 20° in 5 locking position with antishock, seat inclination 8°.
- Sliding seat device 6cm in 5 positions

4. GAS LIFT:

- Height adjustable, swivel, chromed finish
- Height adjustable, swivel, Black finish
- Stool version height adjustable, swivel, chromed finish

5. BASE:

- Fiberglass reinforced polyamide 5 spoke base, Ø 700 mm, black finish
- Polished aluminium 5 spoke base, Ø 700 mm
- Fiberglass reinforced polyamide 5 spoke base, Ø 680 mm, black finish

6. CASTORS/FEET:

- Ø 50 mm self-braking castors, or soft self-bracking. Black finish
- h. 68mm Thermoplastic polimer gliders chromed finish (15µm)
- h. 61 mm polyamide glides, black finish

7. ARMREST:

- Height adj. Armrest, Ellipt. Steel tube 40x20mm, chromed finish (15µm) or powder coated, polyamide pad, black finish (writing tablet in polypropylene)
- Height adj. Armrest, Ellipt. Steel tube 40x20mm, chromed finish (15µm) or powder coated, polyamide pad, black finish or soft polyurethane pad.
- 4D ADJ. ARMREST, in oval steel tube 45x25mm, chromed finish, soft polyurethane pad
- Steel plate fixed armrest, 30x5mm, chromed finish (15µm), upholstered
- Accoudoir fixe plat
- Fixed armrest, round steel tube, Ø16mm, chromed finish (15µm), or powder coated, polyamide top pad, black finish
- Fixed polyamide armrests

1. DOSSIER:

Dossier en polyamide renforcé en fibre de verre, finition noir, en résille, avec soutien lombaire intégré

2. ASSISE:

Assise en polypropylène rembourrée de mousse moulée à froids, tapissée

3. MECANISME:

- Réglable en hauteur, finition noir
- SynchroPlus+, réglage en hauteur, réglage de tension, inclinaison dossier 20° et assise 8°, en 5 positions avec système anti-choq, profondeur d'assise 6 cm en 5 positions

4. VERIN A GAZ:

- Réglable en hauteur, pivotant, finition chromé
- Réglable en hauteur, pivotant, finition noir
- Réglable en hauteur, pivotant, finition chromé, tabouret

5. PIETEMENT:

- Piètement 5 branches en polyamide renforcé en fibre de verre, Ø 700mm, finition noir
- Piètement 5 branches alu poli, Ø 700mm
- Piètement 5 branches en polyamide renforcé en fibre de verre, Ø 680mm, finition noir

6. ROULETTES/PATINS:

- Roulettes Ø 50mm, autofreinantes ou autofreinantes et gommées, finition noir
- Patins en polymère thermoplastique, h. 68mm, finition chromée (15µm)
- Patins en polyamide, h. 61mm, finition noir

7. ACCUDOIR:

- Accoudoir réglable en hauteur en tube d'acier elliptique, 40x20mm, finition chromé (15µm) ou verni époxy, manchette en polyamide, finition noir
- Accoudoir réglable en tube d'acier elliptique, 40x20mm, finition chromé (15µm) ou verni époxy, manchette en polyamide, finition noir ou en polyuréthane souple
- Accoudoir réglable en 4D en tube ovale d'acier, 45x25mm, finition chromé, manchette en polyuréthane souple
- Accoudoir fixe plat en acier, 30x5mm, finition chromé (15µm) (tapissé)
- Accoudoir fixe en tube rond d'acier, Ø 16mm, finition chromé (15µm) ou verni époxy, manchette en polyamide, finition noir
- Accoudoirs fixes polyamide

1. RÜCKENLEHNE:

Schwarze glasfaserverstärktpolyamid Netz Rückenlehne, gestellintegriert stahlrohr, mit integriert lumbalstütze

2. SITZ:

Polypropylen Sitz, ausgepolstert mit Kaltgeschäumten Polyurethan, mit Stoffbezug

3. MECHANIK:

- schwarze Sitzhöhenverstellung
- SynchroPlus+, Gaslift Höhenverstellung, Rückenlehne mit Spannungsregler, 20° Rückenlehneigung, 8° Sitzneigung, 5-stufige Einstellung mit Antishock, 6 cm Sitztiefenverstellung mit 5 Positionen

4. GASFEDER:

- Sitzhöhenverstellung, drehbar, verchromt
- Sitzhöhenverstellung, drehbar, schwarz
- Hocker Sitzhöhenverstellung, drehbar, verchromt

5. GESTELL:

- 5-sterne glasfaserverstärktpolyamid Fußkreuz, Ø 700 mm, schwarz
- 5-Stern Alu poliertes Fußkreuz, Ø 700 mm
- 5-Stern schwarzes glasfaserverstärktes Polyamid Fußkreuz, Ø 680 mm

6. ROLLEN/GLEITER:

- Ø 50 mm gebremste, oder weiche gebremste Rollen, schwarz
- Thermoplastische Polymergleiter, H. 68 mm, verchromt (15 µm)
- Polyamidgleiter, H. 61 mm, schwarz

7. ARMLEHNEN

- Höhenverstellbare Armlehne aus Ellipt. Stahlrohr, 40x20 mm, verchromt (15 µm) oder pulverbeschichtet, schwarze Polyamid Armauflage (Ablageplatte aus Polypropylen)
- Verstellbare Armlehne aus Ellipt. Stahlrohr, 40x20mm, verchromt (15µm) oder pulverbeschichtet, schwarze Polyamid Armauflage oder weichen Polyurethan
- 4D verstellbare Armlehne aus Ellipt. Stahlrohr, 45x25mm, verchromt (15µm) schwarze Polyamid weiche Armaufgabe
- Feste Armlehne aus Flachstahl 30x5 mm, verchromt (15 µm) (Stoff Gepolstert)
- Feste Armlehne aus Stahlrohr, Ø 16 mm, verchromt (15 µm) oder pulverbeschichtet, schwarze Polyamid Armaufgabe
- Ringarmlehnen aus Polyamid



Ecochair

options

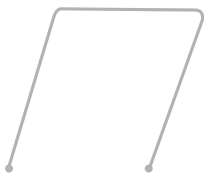

XB001 - metal arm.

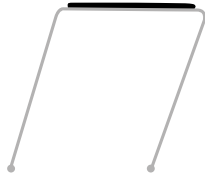

XB002 - metal arm.
uph. pad

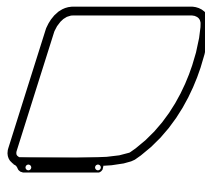

XB019 - fixed polyamide

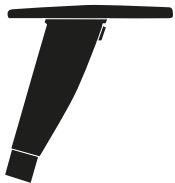

XB046 - height adj.

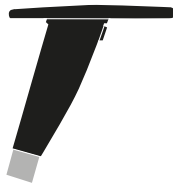

XB017 - chromed
height adj.



XB024 - chromed
4D soft pad

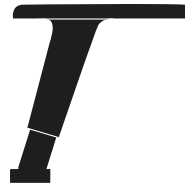

XB020 - 2D
XB021 - 3D



XB018 - chromed 2D
XB082 - chromed 3D

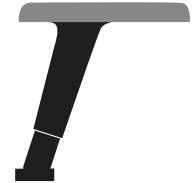

XB022 - 2D soft pad
XB023 - 3D soft pad

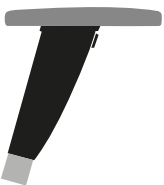

XB025 - chromed
2D soft pad
XB084 - chromed
3D soft pad

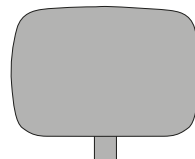

headrest
XT007



XD001 - seat with
springs



XP001
footrest ring
for high gas version only

Ecochair

Cantilever



Ecochair

Fissa, schienale in poliamide, struttura in metallo.

Visitor, polyamide shell, metal structure.

Visiteur, dossier en polyamide, structure en métal.

Besucher, Polyamid rückenlehne, metallgestell.



versions

Ecochair
Cantilever



Ecochair
4-legs



Ecochair
4-legs castors



Ecochair

Cantilever



Ecochair
Cantilever

Ecochair

4-legs



Ecochair

4-legs





Ecochair

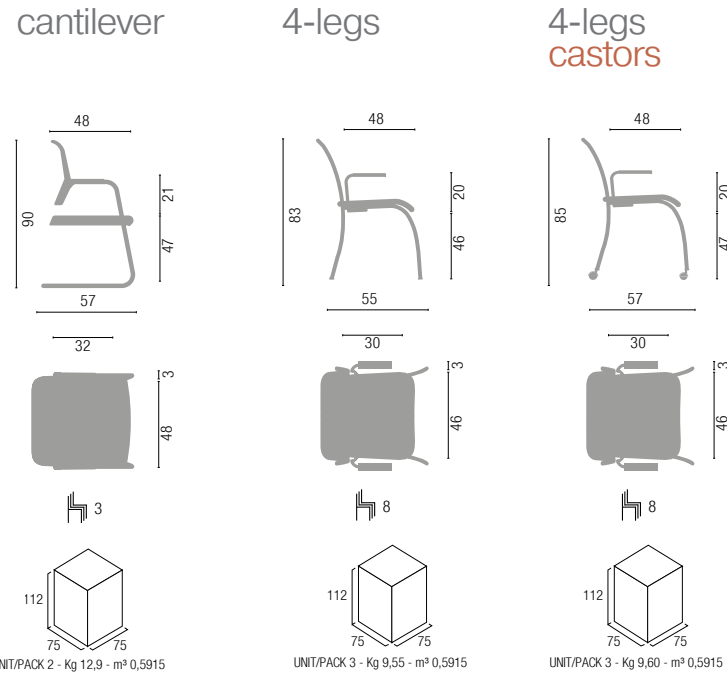

Ecochair



technical data

seat

Sedile rotondo
Round seat
Assise arrondie
Sitz rund

Sedile squadrato
Square seat
Assise carrée
Sitz eckig

options

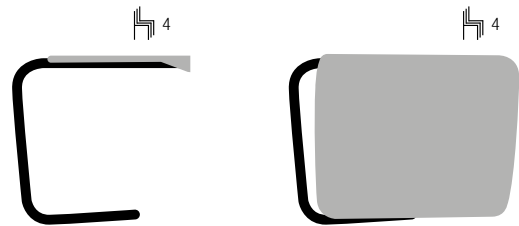

XB043 - grey
XB044 - chromed
XB045 - black

XS003 - writing tablet

base



Base a slitta cromata con braccioli
Chromed cantilever base with arms
Pièt. luge chromé avec accoudoirs
Freischwinger Gestell verch. mit Arml.



Base 4 gambe cromata, vern. grigia o nera
4-legs chromed, grey or black painted base
Pièt. 4 pieds chromé, verni gris ou noir
4-Fuß Gestell verchromt, grau oder schwarz pulverb.



Base 4 gambe con ruote cromata, vern. grigia o nera
4-legs chromed, grey or black painted base, on castors
Pièt. 4 pieds chromé, verni gris ou noir, sur roulettes
4-Fuß Gestell verchromt, mit Rollen, grau oder schwarz pulverb.

feet/castors



1. SCHIENALE:

Schienale in poliamide con carica di fibra di vetro, finitura nera, o schienale in tubo d'acciaio integrato alla base, rivestito in rete

2. SEDILE:

- Sedile in multistrato di legno con spugna, rivestita in tessuto
- Sedile in polipropilene imbottito con spugna, rivestita in tessuto

3. BASE:

- Base a slitta in tubo d'acciaio Ø 25mm, finitura cromata (15µm) o verniciata a polveri
- Base 4 gambe in tubo d'acciaio Ø 22mm, finitura cromata (15µm) o verniciata a polveri

4. RUOTE/PIEDINI:

- Ruote Ø 50mm, autofrenanti o autofrenanti e gommate, finitura nera
- Tappi antiribaltamento in poliamide, finitura nera
- Tappi in polipropilene, finitura nera

1. BACKREST:

Fiberglass reinforced polyamide backrest, black finish. Base integrated steel tube backrest, mesh upholstered

2. SEAT:

- Plywood seat, foam padded, fabric upholstery
- Polypropylene seat, foam padded, fabric upholstery

3. BASE:

- Cantilever base, Ø 25mm steel tube, chromed finish (15µm) or powder coated
- 4 Legs base, Ø 22 mm steel tube, chromed finish (15µm) or powder coated

4. CASTORS/FEET:

- Ø 50 mm self-braking castors, or soft self-bracking. Black finish
- Polyamide anti overturning plugs, black finish
- h.61 mm steel and polyamide glides, black finish
- polypropylene plugs, black finish

1. DOSSIER:

Dossier en polyamide renforcé en fibre de verre, finition noir, en résille

2. ASSISE:

- Assise en multiplie de bois, rembourrée de mousse, tapissée
- Assise en polypropylène rembourrée de mousse, tapissée

3. PIÈTEMENT:

- Piètement luge en tube d'acier Ø 25mm, finition chromé (15µm) ou verni époxy
- Piètement 4 pieds en tube d'acier Ø 22mm, finition chromé (15µm) ou verni époxy

4. ROULETTES/PATINS:

- Roulettes Ø 50mm, autofreinantes ou autofreinantes et gommées, finition noir
- Tampons anti renversement en polyamide noir
- Patin en acier et polyamide, h.61mm, finition noir
- tampons en polypropylène, finition noir

1. RÜCKENLEHNE:

Schwarze glasfaserverstärktpolyamid Netz Rückenlehne, mit Integriert lumbalstütze

2. SITZ:

- Holzstiz, ausgepolstert mit Polyurethanschaum, mit Stoffbezug
- Polypropylen Sitz, ausgepolstert mit Polyurethanschaum, mit Stoffbezug

5. GESTELL:

- Freischwinger Gestell, Ø 25mm Stahlrohr verchromt (15µm) oder pulverbeschichtet
- 4-Fuß Gestell, Ø 22 mm Stahlrohr verchromt (15µm) oder pulverbeschichtet

6. ROLLEN/GLEITER:

- Ø 50 mm gebremste, oder weiche gebremste Rollen, schwarz
- Anti Unkippleiter aus Polyamid, schwarz
- h.61 mm Stahl und schwarze Polyamid Gleiter
- polyamid gleiter, schwarz



Dama

design: AZ Creations

L'apparente semplicità di DAMA è in realtà una declinazione del concetto di eleganza. Dietro a questa famiglia di sedute c'è un percorso progettuale che ha portato alla realizzazione di un oggetto con il senso della misura, senza tempo, pensato e realizzato per chi ricerca qualcosa di mai superato. Proposta nelle due versioni, Rete e Imbottita, la seduta è declinabile in infinite combinazioni, a seconda delle necessità e degli spazi di destinazione.

DAMA's apparent simplicity is actually a declination of the concept of elegance. Behind this line of seats there is a planning process that led to the creation of an object with a sense of proportion, timeless, designed and built for those looking for something never exceeded. Proposed in both versions, Mesh and Upholstered, the seat is declinable in infinite combinations, depending on the needs and the spaces of destination.

La simplicité apparente de DAMA est de fait une déclinaison du concept d'élégance. Derrière cette famille de sièges, il y a un parcours conceptuel qui a conduit à la réalisation d'un objet avec le sens de la mesure, intemporel, pensé et réalisé pour ceux qui cherchent quelque chose qui n'a jamais été dépassée. Proposé dans deux versions, résille et rembourrée, le siège est declinable en combinaisons infinies, en fonction des besoins et des espaces de destination.

Die scheinbare Einfachheit von DAMA ist in der Tat eine Abzweigung des Begriffs zu der Eleganz. Hinter dieser Stuhlfamilie steckt einen Entwicklungsprozess der zur Realisierung im Sinn von zeitlose Produkte gedacht wurde. In zwei Varianten angeboten, mit Netz oder gepolsterte Rückenlehne, ist dieser Stuhl mit umfangreiche Kombinationen zu haben je nach Bedürfnis von verschiedenen gezielte Räume.



Dama

High



Dama

Girevole, imbottita o rete, supporto lombare regolabile. Schienale medio o alto.

Swivel, upholstered or mesh, adj. lumbar support. Medium or high backrest.

Pivotant, rembourré ou résille, soutien lombaire régl. Moyen ou haut dossier.

Drehbar, Gepolstert oder Netz, verstellbare Lumbalstütze. Mittlere oder hohe Rückenlehne.

versions



Dama

High



Dama

Headrest

Dama

Adjustable headrest



Dama

Headrest



Dama

Mesh



Dama
High & Medium

Dama
Medium



Dama



technical data

mechanism

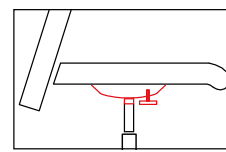

Piastra
Seat plate
Platine
Sitzplatte

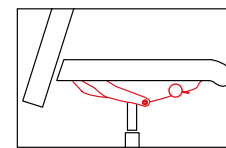

Meccanismo SynchroPlus+ con
traslazione sedile
SynchroPlus+ mechanism with sliding
seat device
SynchroPlus+ avec translation d'assise
SynchroPlus+ Mechanik mit Schiebesitz

base



Base 5 razze poliamide nera
5-spoke black polyamide base
Piët. 5 branches polyam. noir
5-Stern schwarzes Polyamid Fußkreuz



Base 5 razze in alluminio lucida
5-spoke polished aluminium base
Piët. 5 branches alu poli
5-Stern Alu poliertes Fußkreuz

castors



backrest Headrest

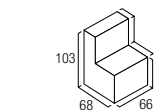
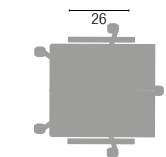
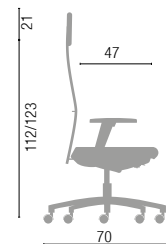

UNIT/PAK 1 - Kg 16,44 - m³ 0,4

backrest High

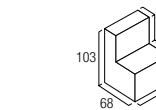
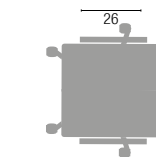
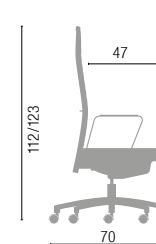

UNIT/PAK 1 - Kg 16,44 - m³ 0,4

backrest Medium

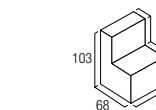
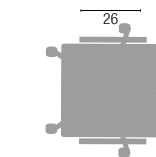
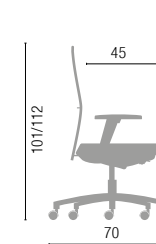

UNIT/PAK 1 - Kg 15,74 - m³ 0,4



Dama

1. SCHIENALE:

Schienale in tubo ovale d'acciaio, 30x15mm, finitura verniciata a polveri, rivestita in rete o tessuto

2. SEDILE:

Sedile in polipropilene imbottito con spugna schiumata a freddo, rivestita in tessuto

3. MECCANISMO:

- Comando elevazione a gas, finitura nera
- SynchroPlus+, comando elevazione a gas, regolazione tensione schienale, inclinazione 20°sch. 8°sed. in 5 posizioni con antishock, traslazione sed. 6cm in 5 posizioni
- Comando elevazione a gas, finitura nera

4. GAS:

- Regolabile in altezza, rotazione, finitura cromata
- Regolabile in altezza, rotazione, finitura nera

5. BASE:

- Base 5 razze in alluminio, Ø 700mm, finitura lucida
- Base 5 razze in poliamide con carica di fibra di vetro, Ø 680mm, finitura nero

6. RUOTE:

Ruote Ø 50mm, autofrenanti o autofrenanti e gommata, finitura nera

7. BRACCIOLI:

- Bracciolo regolabile in poliamide, finitura nera, con top in poliamide, finitura nera, o top in poliuretano morbido
- Bracciolo regolabile in tubo ellittico d'acciaio, 40x20mm, finitura cromata (15µm) o verniciata a polveri, con top in poliamide, finitura nera, o top in poliuretano morbido
- Bracciolo regolabile in 4D in tubo ovale d'acciaio, 45x25mm, finitura cromata, con top in poliuretano morbido
- Bracciolo fisso in piatto d'acciaio, 30x5mm, finitura cromata (15µm) (rivestito in tessuto)
- Braccioli fissi poliamide

1. BACKREST:

Oval steel tube 30x15mm backrest, powder coated, upholstered in mesh or fabric.

2. SEAT:

Polypropylene seat, cold injected foam padded, fabric upholstery

3. MECHANISM:

- Height adjustable, Black finish
- SynchroPlus+, gas lift height adj. Backrest tension adj. backrest inclination 20° in 5 locking position with antishock, seat inclination 8°. Sliding seat device 6cm in 5 positions

4. GAS LIFT:

- Height adjustable, swivel, chromed finish
- Height adjustable, swivel, Black finish

5. BASE:

- Polished aluminium 5 spoke base, Ø 700 mm
- Fiberglass reinforced polyamide 5 spoke base, Ø 680 mm, black finish

6. CASTORS:

Ø 50 mm self-braking castors, or soft self-bracking. Black finish

7. ARMREST:

- Black Polyamide adj. armrest, black polyamide top or soft black polyuretane pad
- Height adj. Armrest, Ellipt. Steel tube 40x20mm, chromed finish (15µm) or powder coated, polyamide pad, black finish or soft polyuretane pad.
- 4D ADJ. ARMREST, in oval steel tube 45x25mm, chromed finish, soft polyuretane pad
- steel plate fixed armrest, 30x5mm, chromed finish (15µm), upholstered
- Fixed polyamide armrests

1. DOSSIER:

Dossier en tube d'acier ovale, 30x15mm, finition verni époxy, en résille ou tapissé

2. ASSISE:

Assise en polypropylène rembourrée de mousse moulée à froids, tapissée

3. MECANISME:

- Réglable en hauteur, finition noir
- SynchroPlus+, réglage en hauteur, réglage de tension, inclinaison dossier 20° et assise 8°, en 5 positions avec système anti-choc, profondeur d'assise 6 cm en 5 positions

4. VERIN A GAZ:

- Réglable en hauteur, pivotant, finition chromé
- Réglable en hauteur, pivotant, finition noir

5. PIETEMENT:

- Piètement 5 branches alu poli, Ø 700mm
- Piètement 5 branches en polyamide renforcé en fibre de verre, Ø 680mm, finition noir

6. ROULETTES:

Roulettes Ø 50mm, autofreinantes ou autofreinantes et gommées, finition noir

7. ACCUDOIR:

- Accoudoir réglable en polyamide, finition noir, manchette en polyamide, finition noir ou en polyuréthane souple
- Accoudoir réglable en tube d'acier elliptique, 40x20mm, finition chromé (15µm) ou verni époxy, manchette en polyamide, finition noir ou en polyuréthane souple
- Accoudoir réglable en 4D en tube ovale d'acier, 45x25mm, finition chromé, manchette en polyuréthane souple
- Accoudoir fixe plat en acier, 30x5mm, finition chromé (15µm) (tapissé)
- Accoudoirs fixes polyamide

1. RÜCKENLEHNE:

Ovalstahlrohr 30x15mm Rückenlehne, pulverbeschichtet, Netz gepolstert oder Stoffbezug.

2. SITZ:

Polypropylen Sitz, ausgepolstert mit kaltgeschäumten Polyurethan, mit Stoffbezug

3. MECHANIK:

- schwarze Sitzhöhenverstellung
- SynchroPlus+, Gaslift Höhenverstellung, Rückenlehne mit Spannungsregler, 20° Rückenlehneigung, 8° Sitzneigung, 5-stufige Einstellung mit Antishock, 6 cm Sitztiefenverstellung mit 5 Positionen

4. GASFEDER:

- Sitzhöhenverstellung, drehbar, verchromt
- Sitzhöhenverstellung, drehbar, schwarz

5. GESTELL:

- 5-Stern Alu poliertes Fußkreuz, Ø 700 mm
- 5-Stern schwarzes glasfaserverstärktes Polyamid Fußkreuz, Ø 680 mm

6. ROLLEN:

Ø 50 mm gebremste, oder weiche gebremste Rollen, schwarz



EN 13335

D.Lgs 81

EN 16139

EN 1728

5 YEAR WARRANTY

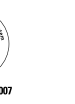

Certification and guarantee of absolute product quality

ISO 9001:2008 Quality

ISO 14001:2004 Environmental

OHSAS 18001:2007 Safety

Dama

options

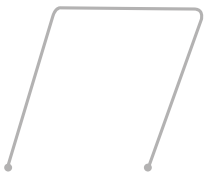

XB001 - metal arm.

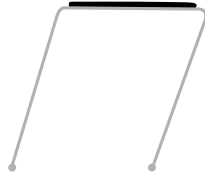

XB002 - metal arm.
uph. pad

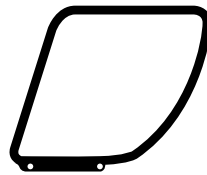

XB019 - fixed polyamide

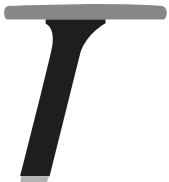

XB024 - chromed
4D soft pad

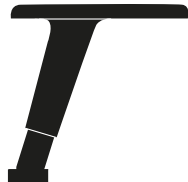

XB020 - 2D
XB021 - 3D

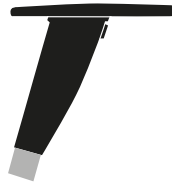

XB082 - chromed 3D

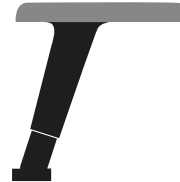

XB022 - 2D soft pad
XB023 - 3D soft pad



XB084 - chromed
3D soft pad



headrest
XT003

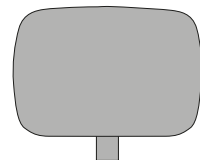

headrest
XT011



XD004 - seat with springs

Dama

4-legs



Dama

Fissa, imbottita o rete,
struttura in metallo.

Visitor, upholstered or mesh,
metal structure.

Visiteur, rembourré ou résille,
structure en métal.

Besucher, gepolstert oder netz,
metallgestell.



versions

Dama
Cantilever

Dama
4-legs





Dama
4-legs



Dama
Cantilever & 4-legs

Dama

Cantilever



OPERATIVE
collection

Dama



technical data

options

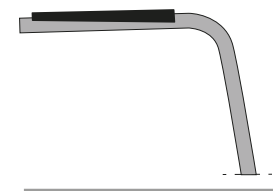

XH009 - black polyamide pad
XH010 - uph. polyamide pad

1. SCHIENALE:

Schienale in tubo d'acciaio Ø 20mm, rivestito in rete o in tessuto

2. SEDILE:

Sedile in multistrato di legno con spugna, rivestita in tessuto

3. BASE:

- Base 4 gambe in tubo d'acciaio Ø 20mm, finitura cromata (15µm)
- Base a slitta in tubo d'acciaio Ø 25mm, finitura cromata (15µm)

4. PIEDINI:

- Tappi antiribaltamento in poliamide, finitura nera
- Tappi in polipropilene, finitura nera

1. BACKREST:

Ø20mm steel tube backrest, upholstered in fabric or Mesh

2. SEAT:

Plywood seat, foam padded, fabric upholstery

3. BASE:

- Cantilever base, Ø 25mm steel tube, chromed finish (15µm)
- 4 legs base, Ø20 mm steel tube, chromed finish (15µm)

4. FEET:

- Polyamide anti overturning plugs, black finish
- Polypropylene plugs, black finish

1. DOSSIER:

Dossier en tube d'acier Ø 20 mm, en résille ou tapissé

2. ASSISE:

Assise en multiplie de bois, rembourrée de mousse, tapissée

3. PIÈTEMENT:

- Piètement luge en tube d'acier Ø 25mm, finition chromé (15µm)
- Piètement 4 pieds en tube d'acier Ø 20mm, finition chromé (15µm)

4. PATINS:

- Patins anti renversement en polyamide, finition noir
- Patins en polypropylène, finition noir

cantilever

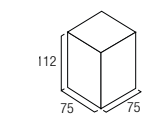
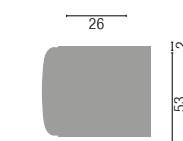
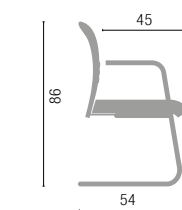

UNIT/PACK 1 - Kg 13,84 - m³ 0,5915

OPERATIVE 227

4-legs

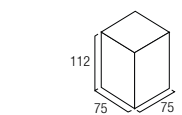
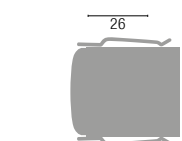
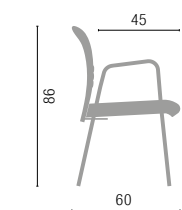

UNIT/PACK 2 - Kg 13,85 - m³ 0,5915

base



Base a slitta cromata con braccioli
Chromed cantilever base with arms
Pièt. luge chromé avec accoudoirs
Freischwinger Gestell verch. mit Armf.



Base 4 gambe con braccioli cromata
4-legs chromed base with arms
Pièt. 4 pieds chromé avec acc.
4-Fuß Gestell verchromt mit Armf.

feet



EN 1335

D.Lgs 81

EN 16139

EN 1728

5 YEAR WARRANTY



OPERATIVE
collection

Flexa

design: AZ Creations

FLEXA è il nuovo traguardo delle sedute operative: estremamente confortevole, flessibile alle esigenze, colorata e divertente. Si adatta a spazi operativi moderni e creativi, senza rinunciare, nelle versioni black&white, all'eleganza che contraddistingue la Moving. Il supporto a forma di Y bianco o nero è realizzato con tecnopolimero ad alta resistenza meccanica e lo schienale disponibile in 7 colori è polipropilene in co-polimero ad alto modulo.

Flexa is the new goal of the task chairs: extremely comfortable, flexible to your needs, colourful and funny. It can be used in operative modern areas without losing the distinguished elegance of a MOVING product in its black&white versions.

The Y shaped spine support in white or black colour is made of engineering polymer with high mechanic resistance while the backrest is available in 7 colours and it's made of polypropylene copolymer high modulus.

FLEXA est la ligne d'arrivée des sièges opératifs : extrêmement confortable, flexible, coloré et sympa. Il s'adapte à des espaces de travail modernes et créatifs, sans renoncer, dans les versions black&white, à l'élégance qui distingue les produits Moving. Le soutien du dossier en forme de Y blanc ou noir est réalisé en polymère technique à haute résistance mécanique tandis que le dossier, disponible en 7 couleurs, est en copolymère à haut module.

FLEXA ist ein neues erreichtes Ziel in den Bürodrehstühlen. Sehr komfortabel, flexibel auf die Bedürfnisse, farbig und lustig. Dieses Modell ist geeignet für moderne und kreative Räume; die Version black&white präsentiert Eleganz typisch von Moving. Die Y-geformte Halterung, weiß oder schwarz, ist aus Technopolymer Kunststoff mit hoher mechanische Widerstandsfähigkeit. Die Rückenlehne welche in 7 Farben verfügbar ist, ist aus Polypropylen Hochmodul-Co-Polymer.





Piece by Piece

Flexa



Flexa

Girevole, schienale in copolimero, sostegno y in polimero tecnico, supporto lombare reg. Supporto bianco o nero.

Swivel, copolimer backrest, Y shaped support in tecnopolimer, adj. Lumbar support. White or black support.

Pivotant, dossier en copolymère, soutiene en forme de polymère technique, soutien lombaire régl. Soutien blanc, soutien noir.

Drehbar, Polyp.-Copolymer Rückenlehne, Techno-Polymer Y geformte Rückenlehnehalter, verstellbare Lumbalstütze. Weiße Rückenlehnstütze, schwarze Rückenlehnstütze.

versions





Moving freedom

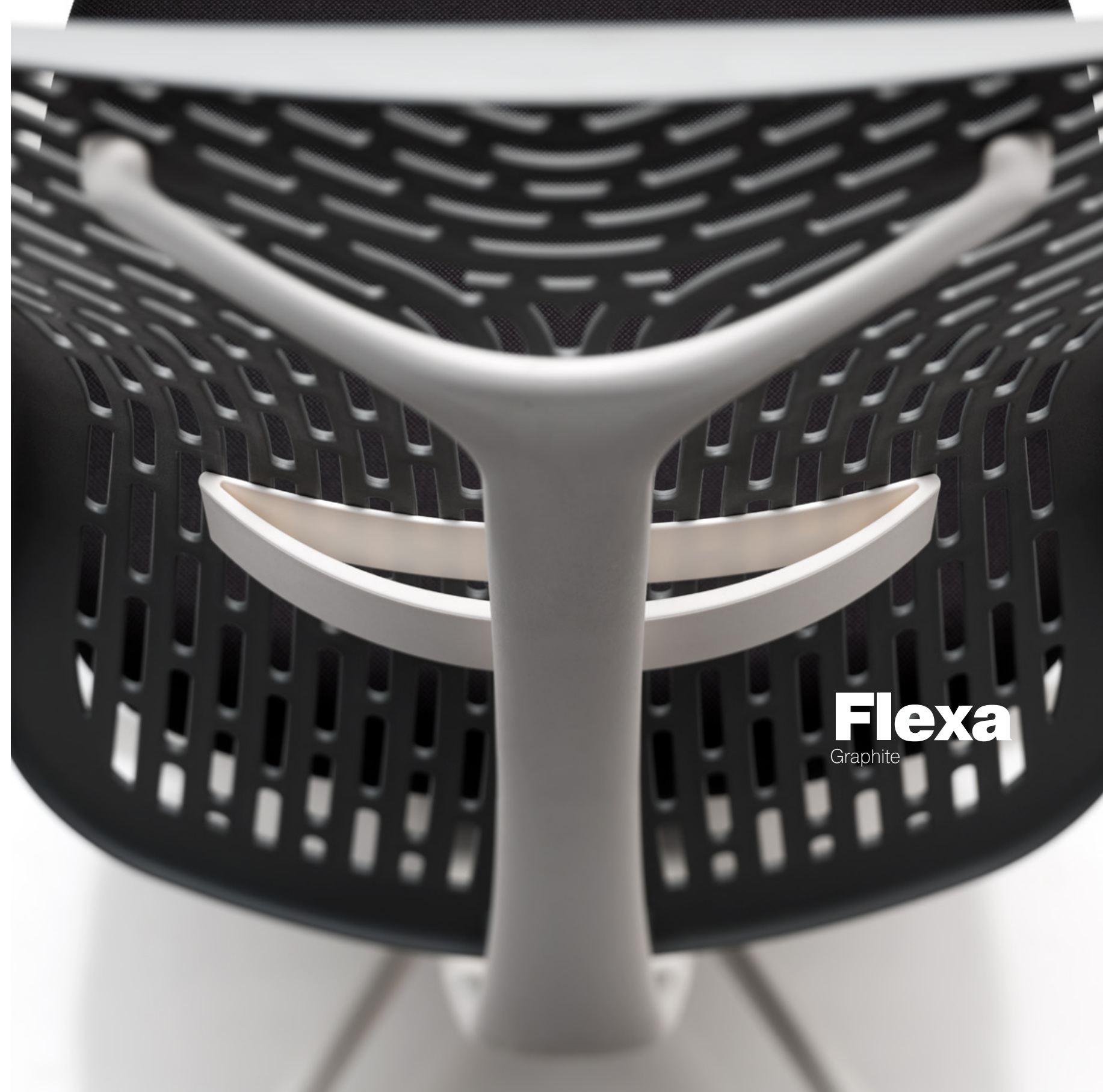

Flexa
Graphite



Flexa
Anis



Flexa
Apricot



Flexa
Graphite

Flexa
Mint



Flexa

Upholstered



Flexa

Upholstered





technical data

mechanism

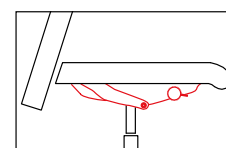

Meccanismo SynchronPlus+ con traslazione sedile
SynchroPlus+ mechanism with sliding seat device
 SynchroPlus+ avec translation d'assise
SynchroPlus+ Mechanik mit Schiebesitz

base



Base 5 razze poliamide nera
5-spoke black polyamide base
 Pièt. 5 branches polyam. noir
 5-Stern schwarzes Polyamid Fußkreuz



Base 5 razze design poliamide nera o bianca
5-spoke black or white polyamide design base
 Pièt. design 5 branches polyam. noir ou blanc
 5-Stern schwarzes oder weisses Polyamid Design Fußkreuz



Base 5 razze in alluminio lucida
5-spoke polished aluminium base
 Pièt. 5 branches alu poli
 5-Stern Alu poliertes Fußkreuz

castors

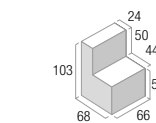
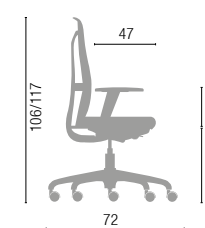
backrest
Medium

UNIT/PACK 1 - Kg 14,24 - m³ 0,4

1. SCHIENALE:

Schienale in polipropilene ad alto modulo, a vista, o imbottita con spugna rivestita in tessuto, con supporto a forma di Y in poliamide con carica di fibra vetro, finitura nera o bianca, con supporto lombare integrato

2. SEDILE:

Sedile in polipropilene imbottito con spugna schiumata a freddo, rivestita in tessuto

3. MECCANISMO:

SynchroPlus+, comando elevazione a gas, regolazione tensione schienale, inclinazione 20°sch. 8°sed. in 5 posizioni con antishock, traslazione sed. 6cm in 5 posizioni

4. GAS:

- Regolabile in altezza, rotazione, finitura cromata
- Regolabile in altezza, rotazione, finitura nera

5. BASE:

- Base 5 razze in poliamide con carica di fibra di vetro, Ø 700mm, finitura nero
- Base 5 razze in alluminio, Ø 700mm, finitura lucida
- Base 5 razze in poliamide con carica di fibra di vetro, Ø 680mm, finitura nero

6. RUOTE:

Ruote Ø 50mm, autofrenanti o autofrenanti e gommate, finitura nera

7. BRACCIOLI:

- Bracciolo regolabile in poliamide, finitura nera, con top in poliamide, finitura nera, o top in poliuretano morbido

- Bracciolo regolabile in poliamide, finitura nera, o top in poliuretano morbido

- Bracciolo regolabile in tubo ellittico d'acciaio, 40x20mm, finitura cromata (15µm) o verniciata a polveri, con top in poliamide, finitura nera

- Bracciolo regolabile in 4D in tubo ovale d'acciaio, 45x25mm, finitura cromata, con top in poliuretano morbido

1. BACKREST:

High modules Polypropylene backrest, optionally foam padded and fabric upholstery. Fiberglass reinforced polyamide Y shaped support. Black or white finishes, integrated lumbar support.

2. SEAT:

polypropylene seat, cold injected foam padded, fabric upholstery

3. MECHANISM:

SynchroPlus+, gas lift height adj. Backrest tension adj. backrest inclination 20° in 5 locking position with antishock, seat inclination 8°. Sliding seat device 6cm in 5 positions

4. GAS LIFT:

- Height adjustable, swivel, chromed finish
- Height adjustable, swivel, Black finish

5. BASE:

- Fiberglass reinforced polyamide 5 spoke base, Ø 700 mm, black finish
- Polished aluminium 5 spoke base, Ø 700 mm
- Fiberglass reinforced polyamide 5 spoke base, Ø 680 mm, black finish

6. CASTORS:

Ø 50 mm self-braking castors, or soft self-braking. Black finish

7. ARMREST:

- Black Polyamide adj.armrest, black polyamide top or soft black polyuretane pad

- White Polyamide adj.armrest, black polyamide top or soft black polyuretane pad

- Adj. Armrest, ellipt. Steel tube 40x20, chromed finish (15µm) or powder coated. Black polyamide pad.

- 4D ADJ. ARMREST, in oval steel tube 45x25mm, chromed finish, soft polyuretane pad

- Adj. Armrest, ellipt. Steel tube 40x20, chromed finish (15µm) or powder coated. Black polyamide pad.

- 4D ADJ. ARMREST, in oval steel tube 45x25mm, chromed finish, soft polyuretane pad

- Adj. Armrest, ellipt. Steel tube 40x20, chromed finish (15µm) or powder coated. Black polyamide pad.

- 4D ADJ. ARMREST, in oval steel tube 45x25mm, chromed finish, soft polyuretane pad

- Adj. Armrest, ellipt. Steel tube 40x20, chromed finish (15µm) or powder coated. Black polyamide pad.

- 4D ADJ. ARMREST, in oval steel tube 45x25mm, chromed finish, soft polyuretane pad

- Adj. Armrest, ellipt. Steel tube 40x20, chromed finish (15µm) or powder coated. Black polyamide pad.

- 4D ADJ. ARMREST, in oval steel tube 45x25mm, chromed finish, soft polyuretane pad

- Adj. Armrest, ellipt. Steel tube 40x20, chromed finish (15µm) or powder coated. Black polyamide pad.

- 4D ADJ. ARMREST, in oval steel tube 45x25mm, chromed finish, soft polyuretane pad

- Adj. Armrest, ellipt. Steel tube 40x20, chromed finish (15µm) or powder coated. Black polyamide pad.

- 4D ADJ. ARMREST, in oval steel tube 45x25mm, chromed finish, soft polyuretane pad

- Adj. Armrest, ellipt. Steel tube 40x20, chromed finish (15µm) or powder coated. Black polyamide pad.

- 4D ADJ. ARMREST, in oval steel tube 45x25mm, chromed finish, soft polyuretane pad

- Adj. Armrest, ellipt. Steel tube 40x20, chromed finish (15µm) or powder coated. Black polyamide pad.

- 4D ADJ. ARMREST, in oval steel tube 45x25mm, chromed finish, soft polyuretane pad

1. DOSSIER:

Dossier en polypropylène haute module, à vue ou rembourré de mousse et tapissé, avec soutien en forme de Y en polyamide renforcé en fibre de verre, finition blanc ou noir, avec soutien lombaire intégré

2. ASSISE:

Assise en polypropylène rembourrée de mousse moulée à froids, tapissée

3. MECANISME:

SynchroPlus+, réglage en hauteur, réglage de tension, inclinaison dossier 20°et assise 8°, en 5 positions avec système anti-choc, profondeur d'assise 6 cm en 5 positions

4. VERIN A GAZ:

- Réglable en hauteur, pivotant, finition chromé
- Réglable en hauteur, pivotant, finition noir

5. PIETEMENT:

- Piètement 5 branches en polyamide renforcé en fibre de verre, Ø 700mm, finition noir

- Piètement 5 branches alu poli, Ø 700mm

- Piètement 5 branches en polyamide renforcé en fibre de verre, Ø 680mm, finition noir

- Piètement 5 branches en polyamide renforcé en fibre de verre, Ø 700mm, finition noir

- Piètement 5 branches en polyamide renforcé en fibre de verre, Ø 680mm, finition noir

- Piètement 5 branches en polyamide renforcé en fibre de verre, Ø 700mm, finition noir

- Piètement 5 branches en polyamide renforcé en fibre de verre, Ø 680mm, finition noir

- Piètement 5 branches en polyamide renforcé en fibre de verre, Ø 700mm, finition noir

- Piètement 5 branches en polyamide renforcé en fibre de verre, Ø 680mm, finition noir

- Piètement 5 branches en polyamide renforcé en fibre de verre, Ø 700mm, finition noir

- Piètement 5 branches en polyamide renforcé en fibre de verre, Ø 680mm, finition noir

- Piètement 5 branches en polyamide renforcé en fibre de verre, Ø 700mm, finition noir

- Piètement 5 branches en polyamide renforcé en fibre de verre, Ø 680mm, finition noir

6. ROULETTES:

Roulettes Ø 50mm, autofrenantes ou autofrenantes et gommées, finition noir

7. ACCUDOIR:

- Accoudoir réglable en polyamide, finition noir, manchette en polyamide, finition noir ou en polyuréthane souple

- Accoudoir réglable en polyamide, finition blanc, manchette en polyamide, finition noir ou en polyuréthane souple

- Accoudoir réglable en tube d'acier elliptique, 40x20mm, finition chromé (15µm) ou verni époxy, manchette en polyamide, finition noir

- Accoudoir réglable en 4D en tube ovale d'acier, 45x25mm, finition chromé, manchette en polyuréthane souple

- Accoudoir réglable en 4D en tube ovale d'acier, 45x25mm, finition chromé, manchette en polyuréthane souple

- Accoudoir réglable en 4D en tube ovale d'acier, 45x25mm, finition chromé, manchette en polyuréthane souple

- Accoudoir réglable en 4D en tube ovale d'acier, 45x25mm, finition chromé, manchette en polyuréthane souple

- Accoudoir réglable en 4D en tube ovale d'acier, 45x25mm, finition chromé, manchette en polyuréthane souple

- Accoudoir réglable en 4D en tube ovale d'acier, 45x25mm, finition chromé, manchette en polyuréthane souple

- Accoudoir réglable en 4D en tube ovale d'acier, 45x25mm, finition chromé, manchette en polyuréthane souple

- Accoudoir réglable en 4D en tube ovale d'acier, 45x25mm, finition chromé, manchette en polyuréthane souple

- Accoudoir réglable en 4D en tube ovale d'acier, 45x25mm, finition chromé, manchette en polyuréthane souple

- Accoudoir réglable en 4D en tube ovale d'acier, 45x25mm, finition chromé, manchette en polyuréthane souple

- Accoudoir réglable en 4D en tube ovale d'acier, 45x25mm, finition chromé, manchette en polyuréthane souple

- Accoudoir réglable en 4D en tube ovale d'acier, 45x25mm, finition chromé, manchette en polyuréthane souple

- Accoudoir réglable en 4D en tube ovale d'acier, 45x25mm, finition chromé, manchette en polyuréthane souple

- Accoudoir réglable en 4D en tube ovale d'acier, 45x25mm, finition chromé, manchette en polyuréthane souple

- Accoudoir réglable en 4D en tube ovale d'acier, 45x25mm, finition chromé, manchette en polyuréthane souple

- Accoudoir réglable en 4D en tube ovale d'acier, 45x25mm, finition chromé, manchette en polyuréthane souple

- Accoudoir réglable en 4D en tube ovale d'acier, 45x25mm, finition chromé, manchette en polyuréthane souple

1. RÜCKENLEHNE:

Rückenlehne aus Polypropylen mit hohem Elastizität Modul, alternativ ausgepolstert mit Schwamm und Stoffbezug. Y geformte Rückenlehnenhalter aus glasfaserverstärkten Polypropylen mit integrierte Lumbalstütze schwarz oder weiss.

2. SITZ:

Polypropylen Sitz, ausgepolstert mit kaltgeschäumten Polyurethan, mit Stoffbezug

3. MECHANIK:

SynchroPlus+, Gaslift Höhenverstellung, Rückenlehne mit Spannungsregler, 20° Rückenlehneigung, 8° Sitzneigung, 5-stufige Einstellung mit Antishock, 6 cm Sitztiefenverstellung mit 5 Positionen

4. GASFEDER:

- Sitzhöhenverstellung, drehbar, verchromt
- Sitzhöhenverstellung, drehbar, schwarz

5. GESTELL:

- 5-stern glasfaserverstärktpolyamid Fußkreuz, Ø 700 mm, schwarz

- 5-Stern Alu poliertes Fußkreuz, Ø 700 mm

- 5-Stern schwarzes glasfaserverstärktes Polyamid Fußkreuz, Ø 680 mm

- 5-Stern schwarzes glasfaserverstärktes Polyamid Fußkreuz, Ø 680 mm

- 5-Stern schwarzes glasfaserverstärktes Polyamid Fußkreuz, Ø 680 mm

- 5-Stern schwarzes glasfaserverstärktes Polyamid Fußkreuz, Ø 680 mm

- 5-Stern schwarzes glasfaserverstärktes Polyamid Fußkreuz, Ø 680 mm

- 5-Stern schwarzes glasfaserverstärktes Polyamid Fußkreuz, Ø 680 mm

- 5-Stern schwarzes glasfaserverstärktes Polyamid Fußkreuz, Ø 680 mm

- 5-Stern schwarzes glasfaserverstärktes Polyamid Fußkreuz, Ø 680 mm

- 5-Stern schwarzes glasfaserverstärktes Polyamid Fußkreuz, Ø 680 mm

- 5-Stern schwarzes glasfaserverstärktes Polyamid Fußkreuz, Ø 680 mm



Flexa

options

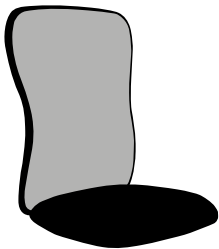

XC018 - upholstered
backrest

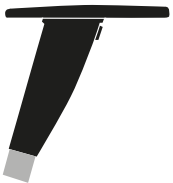

XB018 - chromed 2D

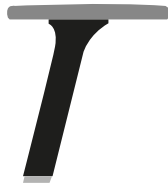

XB024 - chromed
4D soft pad

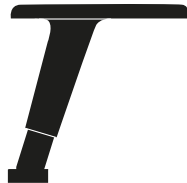

XB020 - 2D
XB021 - 3D

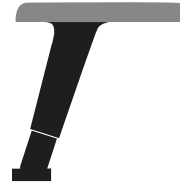

XB022 - 2D soft pad
XB023 - 3D soft pad

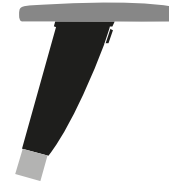

XB025 - chromed
2D soft pad
XB084 - chromed
3D soft pad

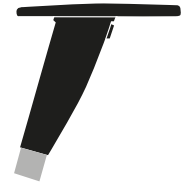

XB082 - chromed 3D

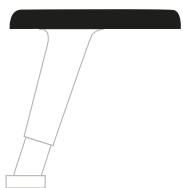

XB077 - white 2D
XB078 - white 3D

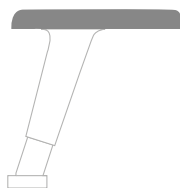

XB079 - white 2D
soft pad
XB080 - white 3D
soft pad



Flexa
Cantilever



Flexa

Fissa, schienale in copolimero, struttura in metallo.

Visitor, copolimer shell, metal structure.

Visiteur, dossier en copolymère, structure en métal.

Besucher, polyp.-copolymer rückenlehne, metallgestell.

versions

Flexa
Cantilever



Flexa
4-legs



Flexa
4-legs castors

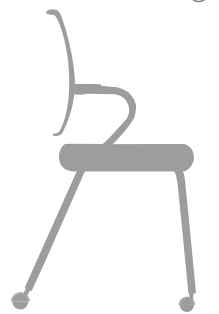



Flexa
Cantilever



Flexa
Cantilever



Flexa

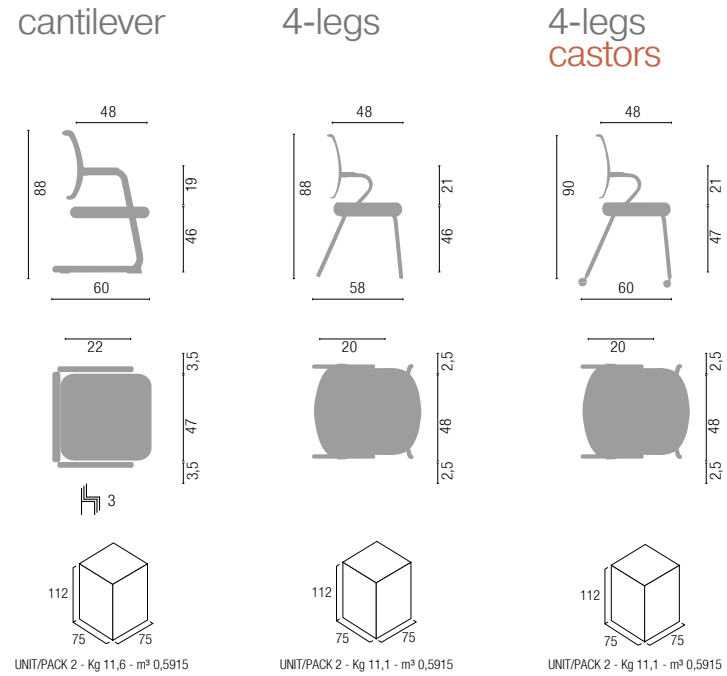

technical data

seat

sedile rotondo
round seat
assise arrondie
Sitz rund

base



feet/castors



options

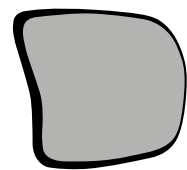

XC019 - upholstered backrest



Base 4 gambe con ruote cromata, vern. bianca o nera
4-legs chromed, white or black painted base, on castors
Pièd. 4 pieds chromé, verni blanc ou noir, sur roulettes
4-Fuß Gestell verchromt, mit Rollen, weiss oder schwarz pulverb

1. SCHIENALE:

Schienale in poliamide con carica di fibra di vetro, finitura nera, o schienale in tubo d'acciaio integrato alla base, rivestito in rete

2. SEDILE:

Sedile in polipropilene imbottito con spugna, rivestita in tessuto

3. BASE:

- Base a slitta in tubo d'acciaio Ø 25mm, finitura cromata (15µm) o verniciata a polveri
- Base 4 gambe in tubo d'acciaio Ø 25mm, finitura cromata (15µm) o verniciata a polveri

4. RUOTE/PIEDINI:

- Ruote Ø 50mm, autofrenanti o autofrenanti, finitura nera
- Tappi antiribaltamento in poliamide, finitura nera
- Tappi in polipropilene, finitura nera

1. BACKREST:

Fiberglass reinforced polyamide backrest, black finish. Base integrated steel tube backrest, mesh upholstered

2. SEAT:

Polypropylene seat, foam padded, fabric upholstery

3. BASE:

- Cantilever base, Ø 25mm steel tube, chromed finish (15µm) or powder coated
- 4 Legs base, Ø 25 mm steel tube, chromed finish (15µm) or powder coated

4. CASTORS/FEET:

- Ø 50 mm self-braking castors, or soft self-bracking. Black finish
- Polyamide anti overturning plugs, black finish
- polypropylene plugs, black finish

1. DOSSIER:

Dossier en polyamide renforcé en fibre de verre, finition noir, en résille

2. ASSISE:

Assise en polypropylène rembourrée de mousse, tapissée

3. PIÈTEMENT:

- Piètement luge en tube d'acier Ø 25mm, finition chromé (15µm) ou verni époxy
- Piètement 4 pieds en tube d'acier Ø 25mm, finition chromé (15µm) ou verni époxy

4. ROULETTES/PATINS:

- Roulettes Ø 50mm, autofreinantes ou autofreinantes et gommées, finition noir
- Patins anti renversement en polyamide noir
- Patins en polypropylène, finition noir

1. RÜCKENLEHNE:

Schwarze glasfaserverstärktpolyamid Netz Rückenlehne, mit Integriert lumbalstütze

2. SITZ:

Polypropylen Sitz, ausgepolstert mit Polyurethanschäum, mit Stoffbezug

3. GESTELL:

- Freischwinger Gestell, Ø 25mm Stahlrohr verchromt (15µm) oder pulverbeschichtet
- 4-Fuß Gestell, Ø 25 mm Stahlrohr verchromt (15µm) oder pulverbeschichtet

4. ROLLEN/GLEITER:

- Ø 50 mm gebremste, oder weiche gebremste Rollen, schwarz
- Anti Unkippleiter aus Polyamid, schwarz
- polyamid gleiter, schwarz



ID 1111210200

Saturno

design: AZ Creations

Saturno è una seduta d'eccezione, che si pone ad un livello elevato nella scala delle operative. L'imbottitura in poliuretano schiumato a freddo regala vero comfort, e lo schienale regolabile in altezza dà supporto lombare e ergonomia. Saturno è disponibile con base in poliamide design, base alluminio e base in poliamide standard; dispone di poggiatesta e appendiabiti, oltre che una vasta gamma di braccioli regolabili.

Saturno is an outstanding seat, at the high level of operative chairs. The cold injected foam padding provide real comfort feeling, the height adj backrest assure ergonomicity and lumbar support. Can be provided with Polyamide design base, polished aluminium base or standard polyamide. As option, could be provided with headrest and coat hanger, and a wide range of adj. armrest.

Saturno est un siège d'exception, qui se place à haut niveau parmi les sièges opératifs. Le rembourrage en mousse moulé à froids fournit un vrai confort ainsi que le dossier réglable en hauteur permet un soutien lombaire ergonomique. Saturno est disponible avec piètement en polyamide « design », piètement alu poli et piètement en polyamide standard ; Comme option, il est disponible l'appui-tête et le porte-manteau et plusieurs accoudoirs réglables.

Saturno ist eine außergewöhnliche Stuhlfamilie die sich in einer gehobenen Ebene unter den Arbeitsdrehstühle darstellt. Die Polsterung aus kaltgeschäumten Polyurethan Schaum ist ein richtiger Komfort mit seiner höhenverstellbare Rückenlehne und Lumbalstütze. Saturno ist mit verschiedenen Fußkreuze zu haben; Polyamid standard oder Polyamid Design und Alu poliert; verschiedene Armlehnen und auf Wunsch Kopfstütze und Kleiderbügel.



Saturno



Saturno

Girevole, imbottita, schienale regolabile in altezza.

Swivel, upholstered, adj. backrest.

Pivotant, rembourré, dossier régl. en hauteur.

Drehbar, gepolstert, höhenverst. Rückenlehne.



versions

Saturno
Headrest



Saturno



Saturno



Saturno

Headrest



Saturno

Saturno





Saturno

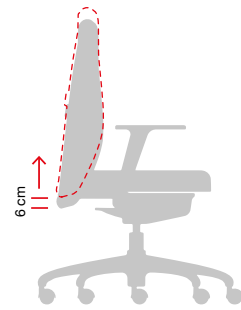

Schienale regolabile in altezza
Height adjustable backrest
Dossier réglable en hauteur
Höhenverst. schwarz

technical data

mechanism

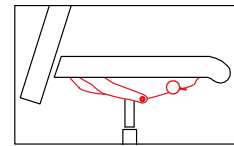

Meccanismo SynchroPlus+ con traslazione sedile
SynchroPlus+ mechanism with sliding seat device
SynchroPlus+ avec translation d'assise
SynchroPlus+ Mechanik mit Schiebesitz

options

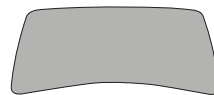

headrest
XT009

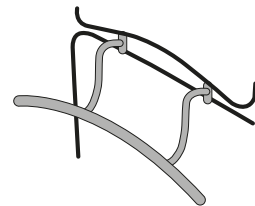

XV001 - grey
XV002 - chromed
XV003 - black

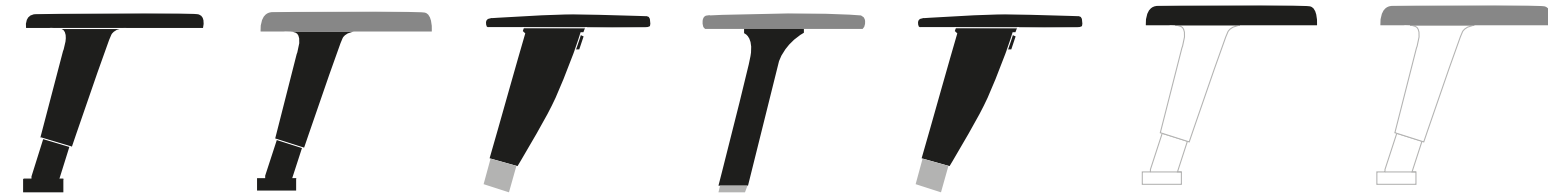

XB020 - 2D
XB021 - 3D

XB022 - 2D soft pad
XB023 - 3D soft pad

XB018 - chromed 2D

XB024 - chromed 4D soft pad

XB082 - chromed 3D

XB077 - white 2D
XB078 - white 3D

XB079 - white 2D soft pad
XB080 - white 3D soft pad

base



Base 5 razze design poliamide nera
5-spoke black polyamide design base
Pièr. design 5 branches polyam. noir
5-Stern schwarzes Polyamid Design Fußkreuz



Base 5 razze in alluminio lucida
5-spoke polished aluminium base
Pièr. 5 branches alu poli
5-Stern Alu poliertes Fußkreuz



Base 5 razze design poliamide nera o bianca
5-spoke black or white polyamide design base
Pièr. design 5 branches polyam. noir ou blanc
5-Stern schwarzes oder weisses Polyamid Design Fußkreuz

castors



backrest Headrest

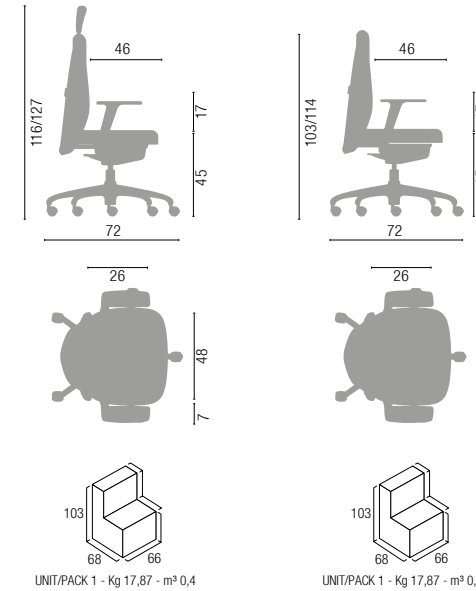

1. SCHIENALE:

Schienale regolabile in altezza (6 cm) in polipropilene, finitura nera, imbottito con spugna schiumata a freddo rivestita in tessuto, con supporto in tubo rettangolare d'acciaio, 60x20mm, finitura verniciata a polveri

2. SEDILE:

Sedile in polipropilene imbottito con spugna schiumata a freddo, rivestita in tessuto

3. MECCANISMO:

SynchroPlus+, comando elevazione a gas, regolazione tensione schienale, inclinazione 20°sch. 8°sed. in 5 posizioni con antishock, traslazione sed. 6cm in 5 posizioni

4. GAS:

- Regolabile in altezza, rotazione, finitura cromata
- Regolabile in altezza, rotazione, finitura nera

5. BASE:

- Base 5 razze in poliamide con carica di fibra di vetro, Ø 700mm, finitura nero
- Base 5 razze in alluminio, Ø 700mm, finitura lucida
- Base 5 razze in poliamide con carica di fibra di vetro, Ø 680mm, finitura nero

6. RUOTE:

Ruote Ø 50mm, autofrenanti o autofrenanti e gommate, finitura nera

7. BRACCIOLI:

- Bracciolo regolabile in poliamide, finitura nera, con top in poliamide, finitura nera, o top in poliuretano morbido
- Bracciolo regolabile in tubo ellittico d'acciaio, 40x20mm, finitura cromata (15µm) o verniciata a polveri, con top in poliamide, finitura nera
- Bracciolo regolabile in 4D in tubo ovale d'acciaio, 45x25mm, finitura cromata, con top in poliuretano morbido

1. BACKREST:

Polypropylene height adjustable backrest (6cm) black finish, cold injected foam padded, fabric upholstery. Rect. Steel tube 60x20mm support, powder coated

2. SEAT:

Polypropylene seat, cold injected foam padded, fabric upholstery

3. MECHANISM:

SynchroPlus+, gas lift height adj. Backrest tension adj. backrest inclination 20° in 5 locking position with antishock, seat inclination 8°. Sliding seat device 6cm in 5 positions

4. GAS LIFT:

- Height adjustable, swivel, chromed finish
- Height adjustable, swivel, Black finish

5. BASE:

- Fiberglass reinforced polyamide 5 spoke base, Ø 700 mm, black finish
- Polished aluminium 5 spoke base, Ø 700 mm
- Fiberglass reinforced polyamide 5 spoke base, Ø 680 mm, black finish

6. CASTORS:

Ø 50 mm self-braking castors, or soft self-braking. Black finish

7. ARMREST:

- Black Polyamide adj. armrest, black polyamide top or soft black polyuretane pad
- Adj. Armrest, ellipt. Steel tube 40x20, chromed finish (15µm) or powder coated. Black polyamide pad.
- 4D ADJ. ARMREST, in oval steel tube 45x25mm, chromed finish, soft polyuretane pad

1. DOSSIER:

Dossier réglable en hauteur (6cm) en polypropylène, finition noir, rembourré de mousse moulée à froids et tapissé, avec soutien en tube d'acier rectangulaire, 60x20mm, finition verni époxy

2. ASSISE:

Assise en polypropylène rembourrée de mousse moulée à froids, tapissée

3. MECANISME:

SynchroPlus+, réglage en hauteur, réglage de tension, inclinaison dossier 20°et assise 8°, en 5 positions avec système anti-choc, profondeur d'assise 6 cm en 5 positions

4. VERIN A GAZ:

- Réglable en hauteur, pivotant, finition chromé
- Réglable en hauteur, pivotant, finition noir

5. PIETEMENT:

- Piètement 5 branches en polyamide renforcé en fibre de verre, Ø 700mm, finition noir
- Piètement 5 branches alu poli, Ø 700mm
- Piètement 5 branches en polyamide renforcé en fibre de verre, Ø 680mm, finition noir

6. ROULETTES:

Roulettes Ø 50mm, autofreinantes ou autofreinantes et gommées, finition noir

7. ACCUDOIR:

- Accoudoir réglable en polyamide, finition noir, manchette en polyamide, finition noir ou en polyuréthane souple
- Accoudoir réglable en tube d'acier elliptique, 40x20mm, finition chromé (15µm) ou verni époxy, manchette en polyamide, finition noir
- Accoudoir réglable en 4D en tube ovale d'acier, 45x25mm, finition chromé, manchette en polyuréthane souple



1. RÜCKENLEHNE:

(6cm) höhenverst. schwarz Polypropylen Rückenlehne, kaltgeschäumten Polyurethan, mit Stoffbezug, Vierkantstahlrohrstütze 60x20mm, pulverbeschichtet

2. SITZ:

Polypropylen Sitz, ausgepolstert mit kaltgeschäumten Polyurethan, mit Stoffbezug

3. MECHANIK:

SynchroPlus+, Gaslift Höhenverstellung, Rückenlehne mit Spannungsregler, 20° Rückenlehneigung, 8° Sitzneigung, 5-stufige Einstellung mit Antishock, 6 cm Sitztiefeverstellung mit 5 Positionen

4. GASFEDER:

- Sitzhöhenverstellung, drehbar, verchromt
- Sitzhöhenverstellung, drehbar, schwarz

5. GESTELL:

- 5-stern glasfaserverstärktpolyamid Fußkreuz, Ø 700 mm, schwarz
- 5-Stern Alu poliertes Fußkreuz, Ø 700 mm
- 5-Stern schwarzes glasfaserverstärktes Polyamid Fußkreuz, Ø 680 mm

6. ROLLEN:

Ø 50 mm gebremste, oder weiche gebremste Rollen, schwarz

7. ARMLEHNEN:

- Verstellbare schwarze Polyamid Armlehne mit Polyamid Armauflage oder mit weiche Polyurethan Armauflage
- Verstellbare Armlehne aus Ellipt. Stahlrohr, 40x20mm, verchromt (15µm) oder pulverbeschichtet, schwarze Polyamid Armauflage
- 4D verstellbare Armlehne aus ovals Stahlrohr, 45x25mm, verchromt (15µm) schwarze Polyamid weiche Armauflage

OPE
RAT
IVE
collection

R&G

design: Ambostudio

MUSEO
NAZIONALE
SCIENZA
E TECNOLOGIA
LEONARDO
DA VINCI

ROMEO & GIULIETTA è una grande famiglia di sedute all'avanguardia per il comfort, e si contraddistingue per la sua forma decisamente originale; oltre alla versione girevole e fissa Romeo & Giuletta viene proposta anche su trave per sale cinema o sale conferenza. Sono disponibili braccioli fissi oppure regolabili, appoggiatesta e appendiabiti. Per le sue innovative caratteristiche ergonomiche, la sedia è stata esposta al Museo Nazionale della Scienza e Tecnologia di Milano.

ROMEO & GIULIETTA is a big family of office chairs at the cutting edge of comfort, and it is distinguished by its very original shape; in addition to the swivel and fixed version, Romeo & Giuletta is also available on bench for cinema halls or conference rooms. There are fixed or adjustable armrests, headrests and coat hangers. For its innovative ergonomic features, the chair was exposed to the National Museum of Science and Technology in Milan.

ROMEO & GIULIETTA est une grande famille de fauteuils de bureau à l'avant-garde pour le confort et elle se distingue pour sa forme très originale ; en plus de la version fixe et pivotante, Romeo & Giuletta est proposée aussi en version poutre pour salles de cinéma ou conférence. Comme option on peut choisir la tête, le porte-manteau, et des accoudoirs fixes ou réglables. Pour ses caractéristiques ergonomiques innovantes, la chaise a été exposée au Musée national des sciences et de la technologie de Milan.

ROMEO & GIULIETTA ist eine große Bürostuhlfamilie mit Vorsprung für seinen Komfort. Dieser Stuhl kennzeichnet sich durch seine sehr besondere Form. Romeo & Giuletta wird nicht nur Drehbar oder mit festen Gestell angeboten, sondern auch mit Bank Sitzträger für Kinosäle und Konferenzräume. Verfügbar mit feste oder verstellbare Armlehnen, und auf Wunsch mit Kopfstütze und Kleiderbügel. Für seine innovativen und ergonomischen Merkmale wurde der Stuhl im Nationalmuseum für Wissenschaft und Technologie in Mailand ausgestellt.



R&G



R&G

Girevole, imbottita, schienale regolabile in altezza. Schienale medio o alto.

Swivel, upholstered, adj. backrest. Medium or high backrest.

Pivotant, rembourré, dossier régl. en hauteur. Moyen ou haut dossier.

Drehbar, gepolstert, höhenverst. Rückenlehne. Mittlere oder hohe Rückenlehne.

versions

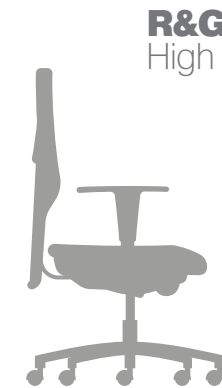

R&G
Headrest



R&G
Headrest



R&G
Medium



R&G
Medium





R&G

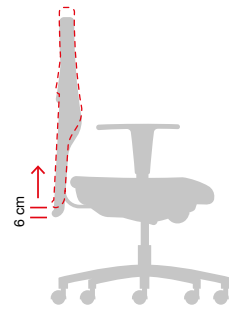

Schienale regolabile in altezza
Height adjustable backrest
Dossier réglable en hauteur
Höhenverst. schwarz

technical data

mechanism

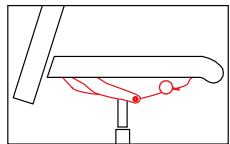

Meccanismo SynchroPlus+ con traslazione sedile
SynchroPlus+ mechanism with sliding seat device
SynchroPlus+ avec translation d'assise
SynchroPlus+ Mechanik mit Schiebesitz

options

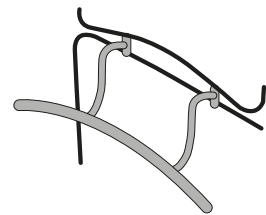
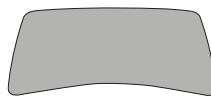

headrest
XT009

XV001 - grey
XV002 - chromed
XV003 - black

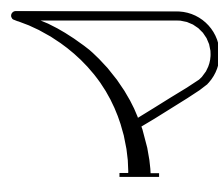

XB048 - fixed polyamide

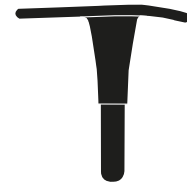

XB049 - height adj.

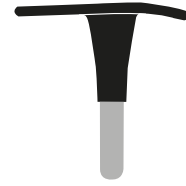

XB072 - chromed height adj.



XB020 - 2D
XB021 - 3D

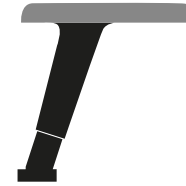

XB022 - 2D soft pad
XB023 - 3D soft pad

base



Base 5 razze poliamide nera
5-spoke black polyamide base
Pièr. 5 branches polyam. noir
5-Stern schwarzes Polyamid Fußkreuz



Base 5 razze in alluminio lucida
5-spoke polished aluminium base
Pièr. 5 branches alu poli
5-Stern Alu poliertes Fußkreuz

castors



backrest
Headrest

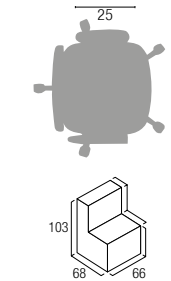
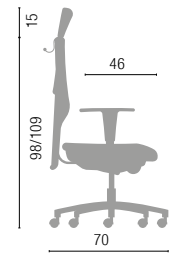

UNIT/PACK 1 - Kg 16,39 - m³ 0,4

backrest
High

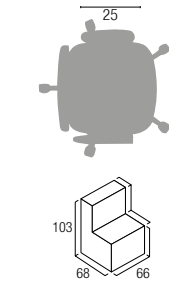
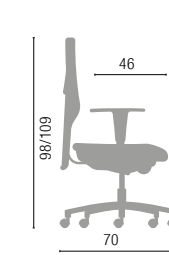

UNIT/PACK 1 - Kg 16,39 - m³ 0,4

backrest
Medium

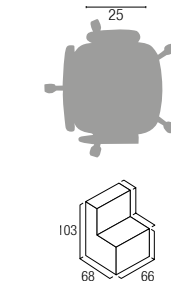
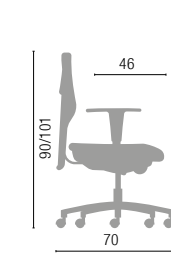

UNIT/PACK 1 - Kg 16,24 - m³ 0,4



1. SCHIENALE:

Schienale regolabile in altezza (6 cm) in polipropilene, finitura nera, imbottito con spugna schiumata a freddo rivestita in tessuto, con supporto in tubo rettangolare d'acciaio, 60x20mm, fin. verniciata a polveri

2. SEDILE:

Sedile in polipropilene imbottito con spugna schiumata a freddo, rivestita in tessuto

3. MECCANISMO:

SynchroPlus+, comando elevazione a gas, regolazione tensione schienale, inclinazione 20°sch. 8°sed. in 5 posizioni con antishock, traslazione sed. 6cm in 5 posizioni

4. GAS:

- Regol. in altezza, rotazione, fin. cromata
- Regol. in altezza, rotazione, finitura nera

5. BASE:

- Base 5 razze in alluminio, Ø 700mm, finitura lucida
- Base 5 razze in poliamide con carica di fibra di vetro, Ø 680mm, finitura nero

6. RUOTE:

Ruote Ø 50mm, autofrenanti o autofrenanti e gommate, finitura nera

7. BRACCIOLI:

- Bracciolo regolabile in poliamide, fin. nera, con top in poliamide, finitura nera, o top in poliuretano morbido
- Bracciolo fisso in poliamide, fin. nera
- Bracciolo regolabile in tubo ellittico d'acciaio, 40x20mm, finitura cromata (15µm) o verniciata a polveri, con top in poliamide, finitura nera

1. BACKREST:

Polypropylene height adjustable backrest (6cm), black finish, cold injected foam padded, fabric upholstery. Rect. Steel tube 60x20mm support, powder coated

2. SEAT:

Polypropylene seat, cold injected foam padded, fabric upholstery

3. MECHANISM:

SynchroPlus+, gas lift height adj. Backrest tension adj. backrest inclination 20° in 5 locking position with antishock, seat inclination 8°. Sliding seat device 6cm in 5 positions

4. GAS LIFT:

- Height adjustable, swivel, chromed finish
- Height adjustable, swivel, Black finish

5. BASE:

- Polished aluminium 5 spoke base, Ø 700 mm
- Fiberglass reinforced polyamide 5 spoke base .Ø 680 mm, black finish

6. CASTORS:

Ø 50 mm self-braking castors, or soft self-braking. Black finish

7. ARMREST:

- Black Polyamide adj.armrest, black polyamide top or soft black polyuretane pad
- Fixed black polyamide arms
- Adj. Armrest, ellipt. Steel tube 40x20, chromed finish (15µm) or powder coated. Black polyamide pad.

1. DOSSIER:

Dossier réglable en hauteur (6cm) en polypropylène, finition noir, rembourré de mousse moulée à froids et tapissé, avec soutien en tube d'acier rectangulaire, 60x20mm, finition verni époxy

2. ASSISE:

Assise en polypropylène rembourrée de mousse moulée à froids, tapissée

3. MECANISME:

SynchroPlus+, réglage en hauteur, réglage de tension, inclinaison dossier 20°et assise 8°, en 5 positions avec système anti-choc, profondeur d'assise 6 cm en 5 positions

4. VERIN A GAZ:

- Réglable en hauteur, pivotant, finition chromé
- Réglable en hauteur, pivotant, finition noir

5. PIÈTEMENT:

- Piètement 5 branches alu poli, Ø 700mm
- Piètement 5 branches en polyamide renforcé en fibre de verre, Ø 680mm, finition noir

6. ROULETTES:

Roulettes Ø 50mm, autofreinantes ou autofreinantes et gommées, finition noir

7. ACCUDOIR:

- Accoudoir réglable en polyamide, finition noir, manchette en polyamide, finition noir ou en polyuréthane souple
- Accoudoir fixe en polyamide, finition noir
- Accoudoir réglable en tube d'acier elliptique, 40x20mm, finition chromé (15µm) ou verni époxy, manchette en polyamide, finition noir

1. RÜCKENLEHNE:

(6cm) höhenverst. schwarz Polypropylen Rückenlehne, kaltgeschäumten Polyurethan, mit Stoffbezug, Vierkantstahlrohrstütze 60x20mm, pulverbeschichtet

2. SITZ:

Polypropylen Sitz, ausgepolstert mit kaltgeschäumten Polyurethan, mit Stoffbezug

3. MECHANIK:

SynchroPlus+, Gaslift Höhenverstellung, Rückenlehne mit Spannungsregler, 20°Rückenlehneigung, 8°Sitzneigung, 5-stufige Einstellung mit Antishock, 6 cm Sitztiefeverstellung mit 5 Positionen

4. GASFEDER:

- Sitzhöhenverstellung, drehbar, verchromt
- Sitzhöhenverstellung, drehbar, schwarz

5. GESTELL:

- 5-Stern Alu poliertes Fußkreuz, Ø 700 mm
- 5-Stern schwarzes glasfaserverstärktes Polyamid Fußkreuz, Ø 680 mm

6. ROLLEN:

Ø 50 mm gebremste, oder weiche gebremste Rollen, schwarz

7. ARMLEHNEN:

- Verstellbare schwarze Polyamid Armlehne mit Polyamid Armauflage oder mit weiche
- Polyurethan Armauflage
- Schwarze, feste Polyamid Armlehne
- Feste Armlehne, Ellipt. Stahlrohr, 40x20mm, verchromt (15µm) oder pulverbeschichtet, schwarze Polyamid Armauflage



R&G

Cinema

Balompie

**R&G**

Fissa, imbottita, struttura in metallo.
Schienale medio.

Visitor, upholstered, metal structure.
Medium backrest.

Visiteur, rembourré, structure en
métal. Moyen dossier.

Besucher, gepolstert, Metallgestell.
Mittlere Rückenlehne.

versions

R&G
Visitor**R&G**
Cinema



visitor

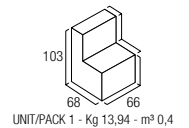
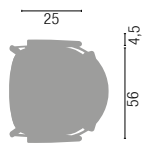
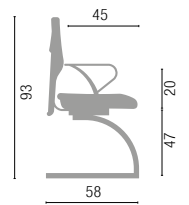

UNIT/PACK 1 - Kg 13,94 - m³ 0,4

technical data

option

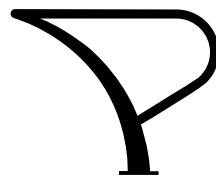

XB048 - fixed polyamide



Base a slitta cromata
Chromed cantilever base
Piètl. luge cromé
Freischwinger Gestell verchromt

base



Base a slitta vern. nera
Black painted cantilever base
Piètl. luge verni noir
Freischwinger Gestell schwarz lackiert

feet



1. SCHIENALE:
Schienale in polipropilene, finitura nera, imbottito con spugna schiumata a freddo rivestita in tessuto, con supporto in tubo rettangolare d'acciaio, 60x20mm, finitura verniciata a polveri

2. SEDILE:
Sedile in polipropilene imbottito con spugna schiumata a freddo, rivestita in tessuto

3. BASE:
Base a slitta in tubo rettangolare d'acciaio, 30x15mm, finitura cromata (15µm) .finitura cromata o nera

4. PIEDINI:
Tappi in polipropilene, finitura nera

1. BACKREST:
Polypropylene backrest, black finish, cold injected foam padded, fabric upholstery. Rect. Steel tube 60x20mm support, powder coated

2. SEAT:
Polypropylene seat, cold injected foam padded, fabric upholstery

3. BASE:
Cantilever base, 30x15mm, rect. Steel tube, chromed finish (15µm) chromed or black finish

4. FEET:
Polypropylene plugs, black finish

1. DOSSIER:
Dossier en polypropylène, finition noir, rembourré de mousse moulée à froids et tapissé, avec soutien en tube d'acier rectangulaire, 60x20mm, finition verni époxy

2. ASSISE:
Assise en polypropylène rembourrée de mousse moulée à froids, tapissée

3. PIÈTEMENT:
Piètement luge en tube d'acier rectangulaire, 30x15mm, finition chromé (15µm) finition chromé ou noir

4. PATINS:
Tampons en polypropylène, finition noir

1. RÜCKENLEHNE:
Polypropylen Rückenlehne, schwarz kaltgeschäumten Polyurethan, mit Stoffbezug, Vierkantstahlrohrstütze 60x20mm, pulverbeschichtet

2. SITZ:
Polypropylen Sitz, ausgepolstert mit kaltgeschäumten Polyurethan, mit Stoffbezug

3. GESTELL:
Freishwinger Gestell, 30x15 mm Vierkantstahlrohr, verchromt (15µm) verchromt oder schwarz

4. GLEITER:
Gleiter, schwarz oder weiss



cinema

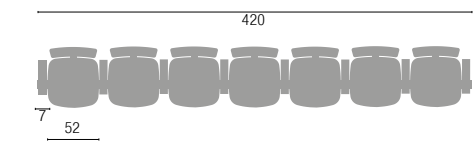
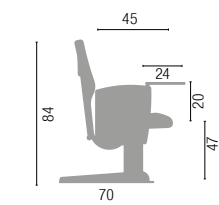

technical data

options

Vedi Listino
See Pricelist
Voir Tarif
Pricelist gesehen

base

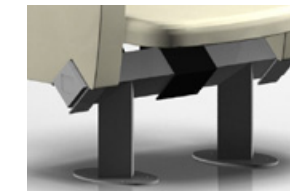

Trave ancorata vern. nera
Black painted bench fixed on floor
Poutre fixe vernie noire
Träger mit Bodenbefestigung schwarz lackiert

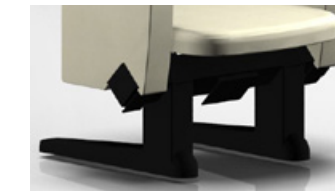

Trave mobile vern. nera
Free standing bench
Poutre amovible vernie noire
Träger-unbefestigt schwarz lackiert

1. SCHIENALE:
Trave 2-7 posti con schienale in polipropilene, finitura nera, imbottito con spugna schiumata a freddo rivestita in tessuto, con supporto in tubo rettangolare d'acciaio, 60x20mm, finitura verniciata a polveri

2. SEDILE:
Sedile per trave in polipropilene imbottito con spugna schiumata a freddo, rivestita in tessuto

3. MECCANISMO:
• Aggancio fisso per trave, nessuna regolazione
• Meccanismo "Sala cinema" per trave, ribaltamento del sedile

4. BASE:
Struttura trave in tubo quadro d'acciaio, 40x40mm, finitura verniciata a polveri, con gambe in poliuretano morbido con struttura portante in acciaio

1. BACKREST:
2/7 seats bench, polypropylene backrest, black finish, cold injected foam padded, fabric upholstery. Rect. Steel tube 60x20mm support, powder coated

2. SEAT:
Polypropylene bench seat, cold injected foam padded, fabric upholstery

3. MECHANISM:
• *Bench fixed seat, no regulations*
• *Bench "cinema" seat tilting mechanism*

4. BASE:
Bench structure, 40x40mm rect. Steel tube, powder coated, soft polyurethane legs with internal steel structure

1. DOSSIER:
Poutre 2-7 places avec dossier en polypropylène, finition noir, rembourré de mousse moulée à froids et tapissé, avec soutien en tube d'acier rectangulaire, 60x20mm, finition verni époxy

2. ASSISE:
Assise en polypropylène rembourrée de mousse moulée à froids, tapissée

3. MECANISME:
• Assise fixe pour poutre, sans réglage
• Mécanisme "Cinéma" pour poutre, assise rabattable

4. PIÈTEMENT:
Poutre en tube d'acier carré, 40x40mm, finition verni époxy, piètement en polyuréthane souple avec structure portante en acier

1. RÜCKENLEHNE:
2/7 Sitzbank, Polypropylen Rückenlehne, Träger schwarz, kaltgeschäumten Polyurethan, mit Stoffbezug, Vierkantstahlrohrstütze 60x20mm, pulverbeschichtet

2. SITZ:
Polypropylen Sitz, ausgepolstert mit kaltgeschäumten Polyurethan, mit Stoffbezug

3. MECHANIK:
• *Festen Hacken zu Sitzbank, keine Regulierung*
• *"Kino" Sitzbank, Klappmechanik*

4. GESTELL:
Quadrat Stahlbalken, 40x40 mm, pulverbeschichtet, weiche Polyurethan Füße mit Stahlinlage



Ultra

design: AZ Creations

z è una famiglia di sedute operative adatte ad un utilizzo giornaliero continuativo; è una seduta che evoca una sensazione di leggerezza e semplicità, ma robustezza allo stesso tempo. È disponibile in versione con base e telaio cromato oppure con base in poliamide nero e telaio verniciato nero, adattabile perciò a diverse esigenze di arredamento. È possibile applicare braccioli regolabili; la versione attesa con base quattro gambe può essere dotata di agganci e di tavoletta.

ULTRA is a family of task office chairs suitable for continuous daily use; it is a chair that evokes a feeling of lightness and simplicity, but strength at the same time. It is available with chromed base and frame, or with black nylon base and black painted frame, therefore adapting to various requirements of furniture. It is possible to apply adjustable arms, the visitor version with 4-leg base can be equipped with linking device and writing tablet.

ULTRA est une famille de sièges opératifs aptes à un usage quotidien continu ; c'est un siège qui évoque une sensation de légèreté et simplicité et au même temps de robustesse. Ultra est disponible avec structure et piètement chromés, ou piètement en polyamide noir et structure époxy noir, ce qui lui permet de s'adapter à plusieurs exigences d'ameublement. C'est possible d'appliquer des accoudoirs réglables ; la version attente 4 pieds peut être équipée de système d'accrochage et tablette écriteire.

ULTRA ist eine Stuhlfamilie für einen täglichen dauerhaften Einsatz. Es handelt sich um einen Stuhl welcher Leichtigkeit und Einfachheit beschwört, aber gleichzeitig auch Stärke. Verfügbar mit verchromten Rahmengerüst der Rückenlehne mit Alu Fußkreuz, oder mit schwarzem Polyamid Fußkreuz und schwarze pulverbeschichtete Rahmengerüst der Rückenlehne welche sich für jede Anforderungen der Einrichtungen eignet. Es ist möglich verschiedene verstellbare Armlehnen anzuwenden. Der 4-Fu Besucherstuhl kann mit Verbindungssystem und Schreibplatte ausgestattet werden.



Ultra



Ultra

Girevole, schienale in rete, supporto lombare regolabile. Schienale nero o cromato.

Swivel, mesh backrest, adj. lumbar support. Black or chromed backrest.

Pivotant, dossier en resille, soutien lombaire régl. Dossier noir ou chrome.

Drehbar, Netz Rückenlehne, verstellbare Lumbalstütze. Rückenlehne schwarze oder verchromt.

versions



Ultra



Ultra



Ultra



Ultra



OPE
RATIVE
collection

Ultra



technical data

mechanism

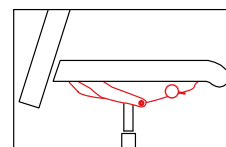

Meccanismo SynchroPlus+ con traslazione sedile
SynchroPlus+ mechanism with sliding seat device
SynchroPlus+ avec translation d'assise
SynchroPlus+ Mechanik mit Schiebesitz

base



Base 5 razze poliamide nera
5-spoke black polyamide base
Piè. 5 branches polyam. noir
5-Stern schwarzes Polyamid Fußkreuz



Base 5 razze in alluminio lucida
5-spoke polished aluminium base
Piè. 5 branches alu poli
5-Stern Alu poliertes Fußkreuz

castors

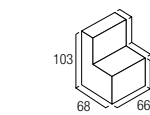
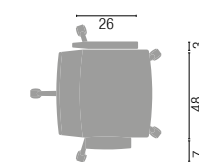
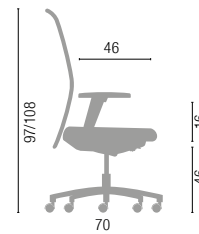

UNIT/PACK 1 - Kg 15,59 - m³ 0,4

1. SCHIENALE:

Schienale in tubo tondo d'acciaio, Ø 20mm, finitura cromata (15µm) o verniciata a polveri, rivestito in rete (poggiareni in poliamide imbottito e rivestito in tessuto)

2. SEDILE:

Sedile in polipropilene imbottito con spugna schiumata a freddo, rivestita in tessuto

3. MECCANISMO:

SynchroPlus+, comando elevazione a gas, regolazione tensione schienale, inclinazione 20° sch. 8° sed. in 5 posizioni con antishock, traslazione sed. 6cm in 5 posizioni

4. GAS:

- Regolabile in altezza, rotazione, finitura cromata
- Regolabile in altezza, rotazione, finitura nera

5. BASE:

- Base 5 razze in alluminio, Ø 700mm, finitura lucida
- Base 5 razze in poliamide con carica di fibra di vetro, Ø 680mm, finitura nero

6. RUOTE:

Ruote Ø 50mm, autofrenanti o autofrenanti e gommate, finitura nera

7. BRACCIOLI:

- Bracciolo regolabile in poliamide, finitura nera, con top in poliamide, finitura nera, o top in poliuretano morbido
- Bracciolo regolabile in 4D in tubo ovale d'acciaio, 45x25mm, finitura cromata, con top in poliuretano morbido

- Bracciolo regolabile in altezza in tubo ellittico d'acciaio, 40x20mm, finitura cromata (15µm) verniciata a polveri, con top in poliamide, finitura nera (tavoletta in polipropilene)

- Bracciolo regolabile in tubo ellittico d'acciaio, 40x20mm, finitura cromata (15µm) o verniciata a polveri, con top in poliamide, finitura nera, o top in poliuretano morbido

1. BACKREST:

Mesh backrest, Ø 20m steel tube structure, Chromed Finish (15µm) or powder coated, (polyamide lumbar support padded and upholstered)

2. SEAT:

polypropylene seat, cold injected foam padded, fabric upholstery

3. MECHANISM:

SynchroPlus+, gas lift height adj. Backrest tension adj. backrest inclination 20° in 5 locking position with antishock, seat inclination 8°. Sliding seat device 6cm in 5 positions

4. GAS LIFT:

- Height adjustable, swivel, chromed finish
- Height adjustable, swivel, Black finish

5. BASE:

- Polished aluminium 5 spoke base, Ø 700 mm
- Fiberglass reinforced polyamide 5 spoke base, Ø 680 mm, black finish

6. CASTORS:

Ø 50 mm self-braking castors, or soft self-bracking. Black finish



7. ARMREST:

- Black Polyamide adj. armrest, black polyamide top or soft black polyurethane pad
- 4D ADJ. ARMREST, in oval steel tube 45x25mm, chromed finish, soft polyurethane pad
- Height adj. Armrest, Ellipt. Steel tube 40x20mm, chromed finish (15µm) or powder coated, polyamide pad, black finish (writing tablet in polypropylene)
- Height adj. Armrest, Ellipt. Steel tube 40x20mm, chromed finish (15µm) or powder coated, polyamide pad, black finish or soft polyurethane pad.

1. DOSSIER:

Dossier en tube d'acier rond, Ø 20mm, finition chromé (15µm) ou verni époxy, revêtu en résille (soutien lombaire en polyamide rembourré et tapissé)

2. ASSISE:

Assise en polypropylène rembourrée de mousse moulée à froids, tapissée

3. MECANISME:

SynchroPlus+, réglage en hauteur, réglage de tension, inclinaison dossier 20° et assise 8°, en 5 positions avec système anti-choc, profondeur d'assise 6 cm en 5 positions

4. VERIN A GAZ:

- Réglable en hauteur, pivotant, finition chromé
- Réglable en hauteur, pivotant, finition noir

5. PIÈTEMENT:

- Piètement 5 branches alu poli, Ø 700mm
- Piètement 5 branches en polyamide renforcé en fibre de verre, Ø 680mm, finition noir

6. ROULETTES:

Roulettes Ø 50mm, autofreinantes ou autofreinantes et gommées, finition noir

7. ACCUDOIR:

- Accoudoir réglable en polyamide, finition noir, manchette en polyamide, finition noir ou en polyuréthane souple
- Accoudoir réglable en 4D en tube ovale d'acier, 45x25mm, finition chromé, manchette en polyuréthane souple
- Accoudoir réglable en hauteur en tube d'acier elliptique, 40x20mm, finition chromé (15µm) ou verni époxy, manchette en polyamide, finition noir
- Accoudoir réglable en tube d'acier elliptique, 40x20mm, finition chromé (15µm) ou verni époxy, manchette en polyamide, finition noir ou en polyuréthane souple

1. RÜCKENLEHNE:

Netz Rückenlehne, Ø20 Stahlrohrrahmen, verchromt (15µm) oder pulverbeschichtet. (ausgepolstert Polyamid Lumbalstütze mit Stoffbezug)

2. SITZ:

Polypropylen Sitz, ausgepolstert mit kaltgeschäumten Polyurethan, mit Stoffbezug

3. MECHANIK:

SynchroPlus+, Gaslift Höhenverstellung, Rückenlehne mit Spannungsregler, 20° Rückenlehneigung, 8° Sitzneigung, 5-stufige Einstellung mit Antishock, 6 cm Sitztiefenverstellung mit 5 Positionen

4. GASFEDER:

- Sitzhöhenverstellung, drehbar, verchromt
- Sitzhöhenverstellung, drehbar, schwarz

5. GESTELL:

- 5-Stern Alu poliertes Fußkreuz, Ø 700 mm
- 5-Stern schwarzes glasfaserverstärktes Polyamid Fußkreuz, Ø 680 mm

6. ROLLEN:

Ø 50 mm gebremste, oder weiche gebremste Rollen, schwarz

7. ARMLEHNEN:

- Verstellbare schwarze Polyamid Armlehne mit Polyamid Armauflage oder mit weiche Polyurethan Armauflage
- 4D verstellbare Armlehne aus ovales Stahlrohr, 45x25mm, verchromt (15µm) schwarze Polyamid weiche Armaufgabe
- Höhenverstellbare Armlehne aus Ellipt. Stahlrohr, 40x20 mm, verchromt (15µm) oder pulverbeschichtet, schwarze Polyamid Armaufgabe (Ablageplatte aus Polypropylen)
- Verstellbare Armlehne aus Ellipt. Stahlrohr, 40x20mm, verchromt (15µm) oder pulverbeschichtet, schwarze Polyamid Armaufgabe oder weichen Polyurethan



EN 1335

TIP A XL

D.Lgs 81

EN 16139

1 IM

EN 9175

5 YEAR WARRANTY



Ultra

options

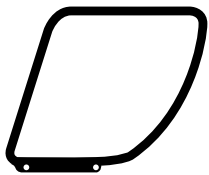

XB019 - fixed
polyamide



XB018 - chromed 2D

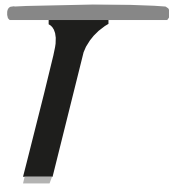

XB024 - chromed
4D soft pad

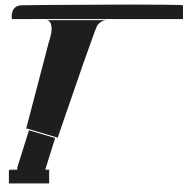

XB020 - 2D
XB021 - 3D

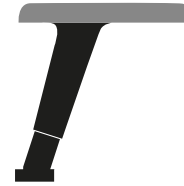

XB022 - 2D soft pad
XB023 - 3D soft pad

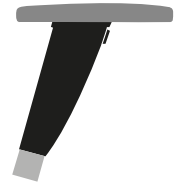

XB025 - chromed
2D soft pad
XB084 - chromed
3D soft pad

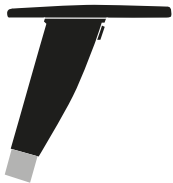

XB082 - chromed 3D



XB046 - height adj.

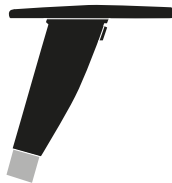

XB017 - chromed
height adj.



XD001 - seat with
springs

Ultra

4-legs castors



Ultra

Fissa, schienale in rete, struttura in metallo. Schienale nero o cromato.

Visitor, mesh backrest, metal structure. Black or chromed backrest.

Visiteur, dossier en résille, structure en métal. Dossier noir ou chromé.

Besucher, Netz Rückenlehne, Metallgestell. Schwarze oder verchromt Rückenlehne.

versions

Ultra
4-legs



Ultra
4-legs castors

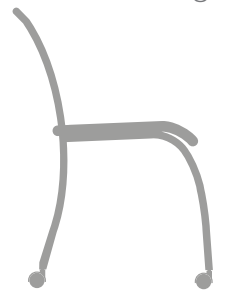



Ultra



4-legs

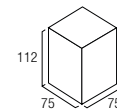
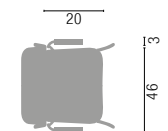
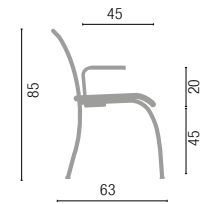

UNIT/PACK 3 - Kg 8,85 - m³ 0,5915

4-legs castors

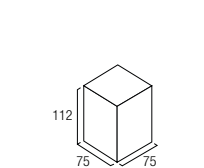
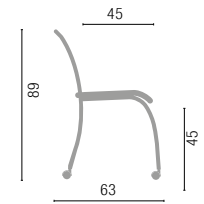

UNIT/PACK 3 - Kg 8,85 - m³ 0,5915

technical data

options

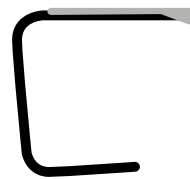

XB044 - chromed
XB045 - black

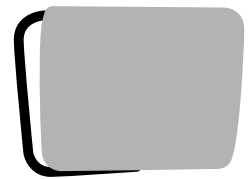

XS003 - writing tablet

base



Base 4 gambe cromata, vern. grigia o nera
4-legs chromed, grey or black painted base
Pièd. 4 pieds chromé, verni gris ou noir
4-Fuß Gestell verchromt, grau oder schwarz pulverb



Base 4 gambe con ruote cromata, vern. grigia o nera
4-legs chromed, grey or black painted base, on castors
Pièd. 4 pieds chromé, verni gris ou noir, sur roulettes
4-Fuß Gestell verchromt, mit Rollen, grau oder schwarz pulverb

feet/castors



Ultra



1. SCHIENALE:

Schienale in tubo d'acciaio integrato alla base, rivestito in rete

2. SEDILE:

Sedile in polipropilene imbottito con spugna, rivestita in tessuto

3. BASE:

Base 4 gambe in tubo d'acciaio Ø 22mm, finitura cromata (15µm) o verniciata a polveri

4. RUOTE/PIEDINI:

- Tappi in polipropilene, finitura nera
- Ruote Ø 50mm, autofrenanti o autofrenanti e gommate, finitura nera

5. BRACCIOLI:

Bracciolo fisso in tubo tondo d'acciaio, Ø 16mm, finitura cromata (15µm) o verniciata a polveri, con top in poliamide, finitura nera

1. BACKREST:

Mesh backrest, steel tube structure

2. SEAT:

polypropylene seat, foam padded, fabric upholstery

3. BASE:

4 legs base, Ø 22 mm steel tube, chromed finish (15µm) or powder coated

4. CASTORS/FEET:

- polypropylene plugs, black finish
- Ø 50 mm self-braking castors, or soft self-bracking. Black finish

5. ARMREST:

Fixed armrest, round steel tube, Ø16mm, chromed finish (15µm), or powder coated, polyamide top pad, black finish

1. DOSSIER:

Dossier en tube d'acier intégré à la structure, en résille

2. ASSISE:

Assise en polypropylène rembourrée de mousse, tapissée

3. PIÈTEMENT:

Piètement 4 pieds en tube d'acier Ø 22mm, finition chromé (15µm) ou verni époxy

4. ROULETTES/PATINS:

- Tampons en polypropylène, finition noir
- Roulettes Ø 50mm, autofreinantes ou autofreinantes et gommées, finition noir

5. ACCOUDOIR:

Accoudoir fixe en tube rond d'acier, Ø 16mm, finition chromé (15µm) ou verni époxy, manchette en polyamide, finition noir

1. RÜCKENLEHNE:

Netz Rückenlehne, Stahlrohrrahmen

2. SITZ:

Polypropylen Sitz, ausgepolstert mit Polyurethan schaum, mit Stoffbezug

3. GESTELL:

4-Fuß Gestell, Ø 22mm Stahlrohr, verchromt (15µm) oder pulverbeschichtet

4. ROLLEN/GLEITER:

- Polyamid Gleiter, schwarz
- Ø 50 mm gebremste, oder weiche gebremste Rollen, schwarz

5. ARMLEHNE:

Feste Armlehne aus Stahlrohr, Ø 16 mm, verchromt (15 µm) oder pulverbeschichtet, schwarze Polyamid Armauflage



OPE
RAT
IVE
collection

Otavo

design: AZ Creations

La famiglia OTAVO racchiude in sé l'essenza della seduta da ufficio:, le quattro versioni girevoli Q, R, D e P disponibili rispondono alle più varie necessità. Dal bisogno di comfort, praticità, così come di ergonomia e resistenza, la sedia Otavo si distingue per la sua adattabilità. È disponibile anche con quattro gambe o slitta. Numerosi colori e materiali di rivestimento completano l'offerta di queste sedute competitive.

The OTAVO family embodies the essence of the Office session:, the four swivel versions available Q, R, D, and P. meet the most different needs. From the need for comfort, convenience, as well as ergonomics and endurance, the Otavo chair stands out for its adaptability. It 'also available with four legs or cantilever. Numerous colors and upholstery materials complement the offerings of these competitive seats.

La famille Otavo exprime l'essence du siège de bureau : Q, R, D et P, les quatre versions pivotantes Q, R, D et P, répondent aux besoins les plus variés. De la nécessité de confort, à l'aspect pratique, ainsi que à l'ergonomie et à la résistance, le siège Otavo se distingue par sa capacité d'adaptation. Il est également disponible en quatre pieds et luge. De nombreuses couleurs et matériaux de revêtement complètent l'offre de ces sièges compétitifs.

Stühle. Die OTAVO-Stuhlfamilie umschließt die Essenz des Bürostuhls. Die vier verfügbare Versionen Q, R, D und P erfüllen die unterschiedlichsten Anforderungen. Von dem Bedürfnis nach Komfort, Bequemlichkeit sowie Ergonomie und Ausdauer, unterscheidet sich der Otavo Stuhl für seine Anpassungsfähigkeit. Vorhanden ist diese Stuhlfamilie auch mit 4-Fuß oder Freischwinger Gestell. Zahlreiche Gewebefarben vervollständigen das Angebot dieser Wettbewerbs Stühle.



OtavoQ

OtavoQ

Girevole, imbottita, supporto lombare regolabile. Schienale regolabile in altezza.

Swivel, upholstered, adj. lumbar support. Adjustable backrest.

Pivotant, rembourré, soutien lombaire régl. Dossier réglable en hauteur.

Drehbar, gepolstert, Lumbalstütze. Höhenverstellbare Rückenlehne.



versions

OtavoQ
Headrest

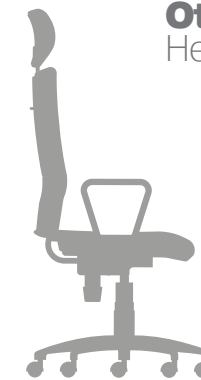

OtavoQ



OtavoQ

Headrest



OtavoQ





OtavoQ

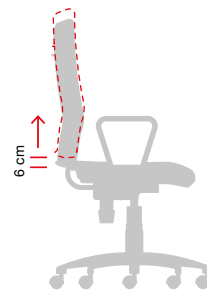

Schienale regolabile in altezza
Height adjustable backrest
Dossier réglable en hauteur
Höhenverst. schwarz

backrest
Headrest

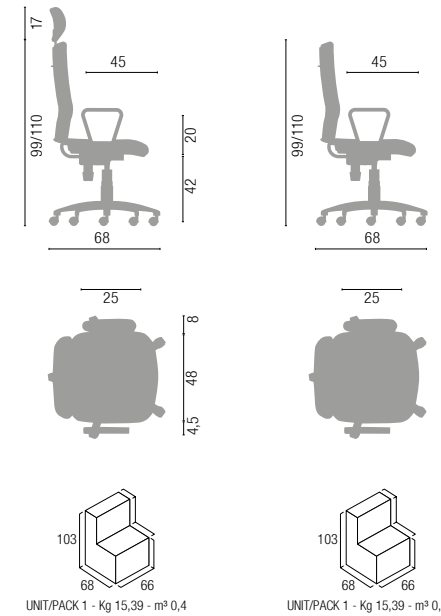

technical data

mechanism

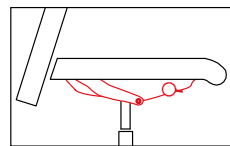

Meccanismo SynchroPlus+ con traslazione sedile
SynchroPlus+ mechanism with sliding seat device
SynchroPlus+ avec translation d'assise
SynchroPlus+ Mechanik mit Schiebesitz

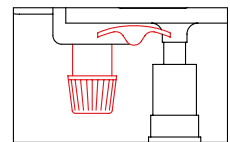

Meccanismo Mini-Synchro
Mini-Synchro mechanism
Mécanisme Mini-Synchro
Mini-Synchro Mechanik

base



Base 5 razze poliamide nera
5-spoke black polyamide base
Piè. 5 branches polyam. noir
5-Stern schwarzes Design Fußkreuz



Base 5 razze poliamide nera
5-spoke black polyamide base
Piè. 5 branches polyam. noir
5-Stern schwarzes Design Fußkreuz

castors



options



XB070 - fixed polyamide

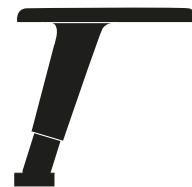

XB020 - 2D

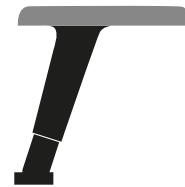

XB022 - 2D soft pad

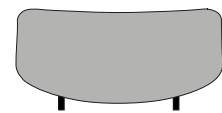

XT008 - headrest

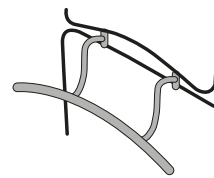

XV001 - grey
XV002 - chromed
XV003 - black

1. SCHIENALE:

Schienale regolabile in altezza (6cm) in polipropilene, finitura nera imbottito con spugna e rivestita in tessuto, con sostegno in tubo rettangolare d'acciaio, 60x20mm, finitura verniciata a polveri

2. SEDILE:

- Sedile in polipropilene imbottito con spugna rivestito in tessuto (per versione con meccanismo Mini-Synchro)
- Sedile in polipropilene imbottito con spugna schiumata a freddo rivestito in tessuto (per versione con meccanismo SynchroPlus+)

3. MECCANISMO:

- SynchroPlus+, comando elevazione a gas, regolazione tensione schienale, inclinazione 20°sch. 8°sed. in 5 posizioni con antishock, traslazione sed. 6cm in 5 posizioni
- Mini-Synchro, comando elevazione a gas, regolazione tensione dello schienale, inclinazione 18°sch. in 5 posizioni con antishock

4. GAS:

Regolabile in altezza, rotazione, fin. nera

5. BASE:

- Base 5 razze in poliamide con carica di fibra di vetro, Ø 640mm, finitura nero
- Base 5 razze in poliamide con carica di fibra di vetro, Ø 680mm, finitura nero

6. RUOTE:

Ruote Ø 50mm, autofrenanti o autofrenanti e gommate, finitura nera

7. BRACCIOLI:

- Bracciolo fisso in poliamide, fin. nera
- Bracciolo regolabile in poliamide, finitura nera, con top in poliamide, finitura nera, o top in poliuretano morbido

1. BACKREST:

Black polypropylene height adjustable backrest (6cm), foam padding and fabric upholstery. Rect. 60x20mm steel tube support, powder coated

2. SEAT:

- Polyprop. seat foam padded with fabric upholstery (for Mini-Synchro mechanism)
- Polyprop. Seat, cold injected foam padding with fabric upholstery for SynchroPlus+

3. MECHANISM:

- SynchroPlus+, gas lift height adj. Backrest tension adj. backrest inclination 20° in 5 locking position with antishock, seat inclination 8°. Sliding seat device 6cm in 5 positions
- Mini-Synchro, gas lift height adj., backrest tension adj. 18° grade with 5 locking position, and antishock

4. GAS LIFT:

Height adjustable, swivel, Black finish

5. BASE:

- Fiberglass reinforced polyamide 5 spoke base, Ø 640 mm, black finish
- Fiberglass reinforced polyamide 5 spoke base, Ø 680 mm, black finish

6. CASTORS:

Ø 50 mm self-braking castors, or soft self-braking. Black finish

7. ARMREST:

- Black Polyamide adj. armrest, black polyamide top or soft black polyurethane pad
- Black Polyamide adj. armrest, black polyamide top or soft black polyurethane pad

1. DOSSIER:

Dossier réglable en hauteur (6cm) en polypropylène, finition noir rembourré de mousse et tapissé, avec soutien en tube d'acier rectangulaire, 60x20mm, finition verni époxy

2. ASSISE:

- Assise en polypropylène rembourrée de mousse et tapissée (pour version mécanisme Mini-Synchro)
- Assise en polypropylène rembourrée de mousse moulée à froids et tapissée (pour version mécanisme SynchroPlus+)

3. MECANISME:

- SynchroPlus+, réglage en hauteur, réglage de tension, inclinaison dossier 20°et assise 8°, en 5 positions avec système anti-choc, profondeur d'assise 6 cm en 5 positions
- Mini-Synchro, réglage en hauteur, réglage de tension, inclinaison dossier 18°en 5 positions avec système antichoc

4. VERIN A GAZ:

Réglable en hauteur, pivotant, finition noir

5. PIÈTEMENT:

- Piètement 5 branches en polyamide renforcé en fibre de verre, Ø 640mm, finition noir
- Piètement 5 branches en polyamide renforcé en fibre de verre, Ø 680mm, finition noir

6. ROULETTES:

Roulettes Ø 50mm, autofreinantes ou autofreinantes et gommées, finition noir

7. ACCUDOIR:

- Accoudoir fixe en polyamide, finition noir
- Accoudoir réglable en polyamide, finition noir, manchette en polyamide, finition noir ou en polyuréthane souple

1. RÜCKENLEHNE:

(6cm) höhenverst. schwarze polypropylen Rückenlehne mit Polyurethanschäum mit Stoffbezug. Vierkantstahlrohrstütze 60x20mm, pulverbeschichtet

2. SITZ:

- Polypropylen Sitz mit Schwamm gepolstert und mit Stoff bezogen. (Mit Mini-Synchro Mechanik)
- Polypropylen Sitz mit kaltgeschäumten Polyurethan Schaum mit Stoff bezogen. (Mit SynchroPlus+ Mechanik)

3. MECHANIK:

- SynchroPlus+, Gaslift Höhenverstellung, Rückenlehne mit Spannungsregler, 20°Rückenlehneigung, 8°Sitzneigung, 5-stufige Einstellung mit Antishock, 6 cm Sitztiefenverstellung mit 5 Positionen
- Mini-Synchro, Gaslift Höhenverstellung, Rückenlehne mit Spannungsregler, 18°Rückenlehneigung mit 5-stufige Stoßdämpfung.

4. GASFEDER:

Sitzhöhenverstellung, drehbar, schwarz

5. GESTELL:

- Stern schwarzes glasfaserverstärktes Polyamid Fußkreuz, Ø 640 mm
- 5-Stern schwarzes glasfaserverstärktes Polyamid Fußkreuz, Ø 680 mm

6. ROLLEN:

Ø 50 mm gebremste, oder weiche gebremste Rollen, schwarz

7. ARMLEHNEN:

- Schwarze, feste Polyamide Armlehne
- Verstellbare schwarze Polyamid Armlehne mit Polyamid Armauflage oder mit weiche Polyurethan Armauflage

OtavoR



OtavoR

Girevole, schienale in rete,
supporto lombare regolabile.

Swivel, mesh backrest, adj.
lumbar support.

Pivotant, dossier en résille,
soutien lombaire régl.

Drehbar, Netz Rückenlehne,
verstellbare Lumbalstütze



versions

OtavoR

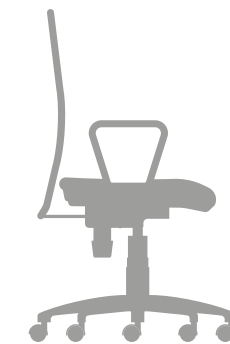

OtavoR



OtavoR





OtavovR

Russia



OtavovR



OtavoR



technical data

mechanism

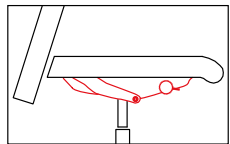

Meccanismo SynchroPlus+ con traslazione sedile
SynchroPlus+ mechanism with sliding seat device
SynchroPlus+ avec translation d'assise
SynchroPlus+ Mechanik mit Schiebesitz

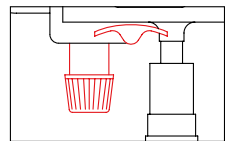

Meccanismo mini synchro
Mini-synchro mechanism
Mécanisme mini-synchro
Mini-Synchro Mechanik

options



XB070 - fixed polyamide

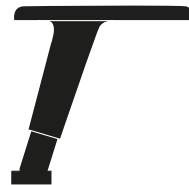

XB020 - 2D

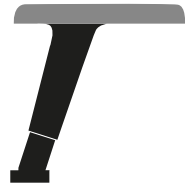

XB022 - 2D soft pad

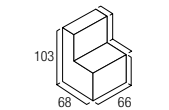
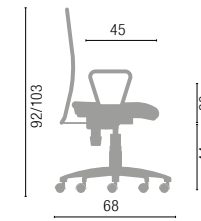

UNIT/PACK 1 - Kg 14,14 - m³ 0,4



base



Base 5 razze poliamide nera
5-spoke black polyamide base
Piè. 5 branches polyam. noir
5-Stern schwarzes Design Fußkreuz



Base 5 razze poliamide nera
5-spoke black polyamide base
Piè. 5 branches polyam. noir
5-Stern schwarzes Design Fußkreuz

castors



1. SCHIENALE:

Schienale in tubo tondo d'acciaio, Ø 20 mm, finitura vern. a polveri rivestito in rete

2. SEDILE:

- Sedile in polipropilene imbottito con spugna rivestito in tessuto (per versione con meccanismo Mini-Synchro)
- Sedile in polipropilene imbottito con spugna schiumata a freddo rivestito in tessuto (per versione con meccanismo SynchroPlus+)

3. MECCANISMO:

- SynchroPlus+, comando elevazione a gas, regolazione tensione schienale, inclinazione 20°sch. 8°sed. in 5 posizioni con antishock, traslazione sed. 6cm in 5 posizioni
- Mini-Synchro, comando elevazione a gas, regolazione tensione dello schienale, inclinazione 18°sch. in 5 posizioni con antishock

4. GAS:

Regolabile in altezza, rotazione, fin. nera

5. BASE:

- Base 5 razze in poliamide con carica di fibra di vetro, Ø 640mm, finitura nero
- Base 5 razze in poliamide con carica di fibra di vetro, Ø 680mm, finitura nero

6. RUOTE:

Ruote Ø 50mm, autofrenanti o autofrenanti e gommate, finitura nera

7. BRACCIOLI:

- Bracciolo fisso in poliamide, finitura nera
- Bracciolo regolabile in poliamide, finitura nera, con top in poliamide, finitura nera, o top in poliuretano morbido

1. BACKREST:

Ø 20mm steel round bar backrest, powder coated, mesh upholstered.

2. SEAT:

- Polyprop. seat foam padded with fabric upholstery (for Mini-Synchro mechanism)
- Polyprop. Seat, cold injected foam padding with fabric upholstery for SynchroPlus+

3. MECHANISM:

- SynchroPlus+, gas lift height adj. Backrest tension adj. backrest inclination 20° in 5 locking position with antishock, seat inclination 8°. Sliding seat device 6cm in 5 positions
- Mini-Synchro, gas lift height adj., backrest tension adj. 18° grade with 5 locking position, and antishock

4. GAS LIFT:

Height adjustable, swivel, Black finish

5. BASE:

- Fiberglass reinforced polyamide 5 spoke base, Ø 640 mm, black finish
- Fiberglass reinforced polyamide 5 spoke base, Ø 680 mm, black finish

6. CASTORS:

Ø 50 mm self-braking castors, or soft self-bracking. Black finish

7. ARMREST:

- Black Polyamide adj. armrest, black polyamide top or soft black polyuretane pad
- Black Polyamide adj. armrest, black polyamide top or soft black polyuretane pad

1. DOSSIER:

Dossier en tube d'acier rond, Ø 20mm, finition verni époxy, revêtu en résille

2. ASSISE:

- Assise en polypropylène rembourrée de mousse et tapissée (pour version mécanisme Mini-Synchro)
- Assise en polypropylène rembourrée de mousse moulée à froids et tapissée (pour version mécanisme SynchroPlus+)

3. MECANISME:

- SynchroPlus+, réglage en hauteur, réglage de tension, inclinaison dossier 20°et assise 8°, en 5 positions avec système anti-choc, profondeur d'assise 6 cm en 5 positions
- Mini-Synchro, réglage en hauteur, réglage de tension, inclinaison dossier 18°en 5 positions avec système antichoc

4. VERIN A GAZ:

Réglable en hauteur, pivotant, finition noir

5. PIÈTEMENT:

- Piètement 5 branches en polyamide renforcé en fibre de verre, Ø 640mm, finition noir
- Piètement 5 branches en polyamide renforcé en fibre de verre, Ø 680mm, finition noir

6. ROULETTES:

Roulettes Ø 50mm, autofreinantes ou autofreinantes et gommées, finition noir

7. ACCUDOIR:

- Accoudoir fixe en polyamide, finition noir
- Accoudoir réglable en polyamide, finition noir, manchette en polyamide, finition noir ou en polyuréthane souple

1. RÜCKENLEHNE:

Ø20mm Stahlrohr Rückenlehne pulverbeschichtet, Netz gepolstert

2. SITZ:

- Polypropylen Sitz mit Schwamm gepolstert und mit Stoff bezogen. (Mit Mini-Synchro Mechanik)
- Polypropylen Sitz mit kaltgeschäumten Polyurethan Schaum mit Stoff bezogen. (Mit SynchroPlus+ Mechanik)

3. MECHANIK:

- SynchroPlus+, Gaslift Höhenverstellung, Rückenlehne mit Spannungsregler, 20°Rückenlehneigung, 8°Sitzneigung, 5-stufige Einstellung mit Antishock, 6 cm Sitztiefenverstellung mit 5 Positionen
- Mzz, Gaslift Höhenverstellung, Rückenlehne mit Spannungsregler, 18°Rückenlehneigung mit 5-stufige Stoßdämpfung.

4. GASFEDER:

Sitzhöhenverstellung, drehbar, schwarz

5. GESTELL:

- Stern schwarzes glasfaserverstärktes Polyamid Fußkreuz, Ø 640 mm
- 5-Stern schwarzes glasfaserverstärktes Polyamid Fußkreuz, Ø 680 mm

6. ROLLEN:

Ø 50 mm gebremste, oder weiche gebremste Rollen, schwarz

7. ARMLEHNEN:

- schwarze, feste Polyamide Armlehne
- Verstellbare schwarze Polyamid Armlehne mit Polyamid Armauflage oder mit weiche Polyurethan Armauflage





OtavoD

OtavoD_P

Girevole, imbottita, schienale regolabile in altezza. Colonna a gas sgabello nera.

Swivel, upholstered, adj. backrest. Black gas cylinder stool version.

Pivotant, rembourré, dossier régl. en hauteur. Vérin a gaz haut noir.

Drehbar, gepolstert, höhenverst. Rückenlehne. Schwarze Hocker Gasfeder.



versions

OtavoD



OtavoP



**OtavoD_P
Stool**



OtavoD

OtavoD



Otavo^P



Otavo^P





OtavoD_P

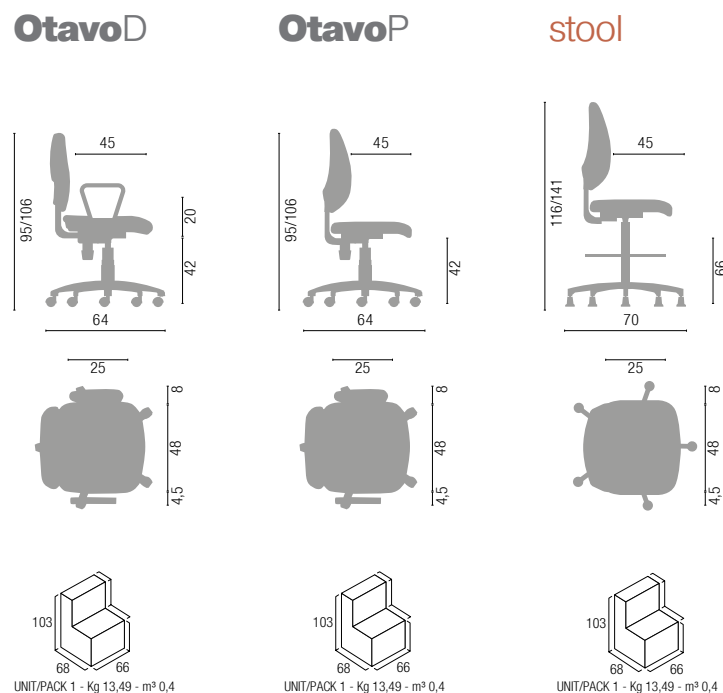

OtavoD



OtavoP



technical data

mechanism

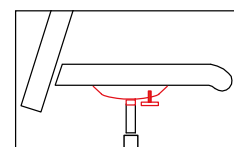

Piastra
Seat plate
Platine
Sitzplatte

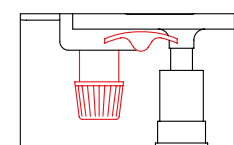

Meccanismo mini synchro
Mini-synchro mechanism
Mécanisme mini-synchro
Mini-Synchro Mechanik

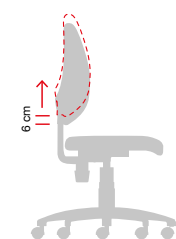

Schienale regolabile in altezza
Height adjustable backrest
Dossier réglable en hauteur
Höhenverst. schwarz

base



Base 5 razze poliamide nera
5-spoke black polyamide base
Piè. 5 branches polyam. noir
5-Stern schwarzes Design Fußkreuz



Base 5 razze poliamide nera
5-spoke black polyamide base
Piè. 5 branches polyam. noir
5-Stern schwarzes Design Fußkreuz

castors/feet



options



XB070 - fixed
polyamide

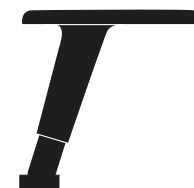

XB020 - 2D

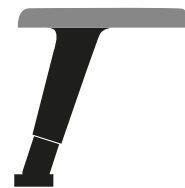

XB022 - 2D soft pad

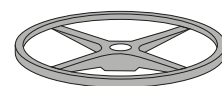

XP001
footrest ring
for high gas version only

1. SCHIENALE:

Schienale regolabile in altezza (6cm) in polipropilene, finitura nera imbottito con spugna e rivestita in tessuto, con sostegno in tubo rettangolare d'acciaio, 60x20mm, finitura verniciata a polveri

2. SEDILE:

Sedile in polipropilene imbottito con spugna, rivestita in tessuto

3. MECCANISMO:

- Mini-Synchro, comando elevazione a gas, regolazione tensione dello schienale, inclinazione 18°sch. in 5 posizioni con antishock
- Comando elevazione a gas, fin. nera

4. GAS:

- Regolabile in altezza, rotazione, fin. nera
- Regolabile in altezza, rotazione, finitura nera, sgabello

5. BASE:

- Base 5 razze in poliamide con carica di fibra di vetro, Ø 640mm, finitura nero
- Base 5 razze in poliamide con carica di fibra di vetro, Ø 680mm, finitura nero

6. RUOTE:

- Ruote Ø 50mm, autofrenanti o autofrenanti e gommate, finitura nera
 - Piedini in poliamide, h. 61mm, finitura nera
- 7. BRACCIOLI:**
- Bracciolo fisso in poliamide, fin. nera
 - Bracciolo regolabile in poliamide, finitura nera, con top in poliamide, finitura nera, o top in poliuretano morbido

1. BACKREST:

Black polypropylene height adjustable backrest (6cm), foam padding and fabric upholstery. Rect. 60x20mm steel tube support, powder coated

2. SEAT:

Polypropylene seat, foam padded, fabric upholstery

3. MECHANISM:

- Mini-Synchro, gas lift height adj., backrest tension adj. 18° grade with 5 locking position, and antishock
- Height adjustable, Black finish

4. GAS LIFT:

- Height adjustable, swivel, Black finish
- Stool version height adjustable, swivel, black finish

5. BASE:

- Fiberglass reinforced polyamide 5 spoke base, Ø 640 mm, black finish
- Fiberglass reinforced polyamide 5 spoke base, Ø 680 mm, black finish

6. CASTORS:

- Ø 50 mm self-braking castors, or soft self-bracking. Black finish
- h.61 mm polyamide glides, black finish

7. ARMREST:

- Black Polyamide adj. armrest, black polyamide top or soft black polyuretane pad
- Black Polyamide adj. armrest, black polyamide top or soft black polyuretane pad

1. DOSSIER:

Dossier réglable en hauteur (6cm) en polypropylène, finition noir rembourré de mousse et tapissé, avec soutien en tube d'acier rectangulaire, 60x20mm, finition verni époxy

2. ASSISE:

Assise en polypropylène rembourrée de mousse, tapissée

3. MECANISME:

- Mini-Synchro, réglage en hauteur, réglage de tension, inclinaison dossier 18° en 5 positions avec système antichoc
- Réglable en hauteur, finition noir

4. VERIN A GAZ:

- Réglable en hauteur, pivotant, finition noir
- Réglable en hauteur, pivotant, finition noir, tabouret

5. PIÈTEMENT:

- Piètement 5 branches en polyamide renforcé en fibre de verre, Ø 640mm, finition noir
- Piètement 5 branches en polyamide renforcé en fibre de verre, Ø 680mm, finition noir

6. ROULETTES:

- Roulettes Ø 50mm, autofreinantes ou autofreinantes et gommées, finition noir
- Patins en polyamide, h.61mm, finition noir

7. ACCUDOIR:

- Accoudoir fixe en polyamide, finition noir
- Accoudoir réglable en polyamide, finition noir, manchette en polyamide, finition noir ou en polyuréthane souple

1. RÜCKENLEHNE:

(6cm) höhenverst. schwarze polypropylen Rückenlehne mit Polyurethanschäum mit Stoffbezug. Vierkantstahlrohrstütze 60x20mm, pulverbeschichtet

2. SITZ:

Polypropylen Sitz, ausgepolstert mit Polyurethan schaum, mit Stoffbezug

3. MECHANIK:

- Mini-Synchro, Gaslift Höhenverstellung, Rückenlehne mit Spannungsregler, 18° Rückenlehneigung mit 5-stufige Stoßdämpfung
- schwarze Sitzhöhenverstellung

4. GASFEDER:

- Sitzhöhenverstellung, drehbar, schwarz
- Hocker Sitzhöhenverstellung, drehbar, schwarz

5. GESTELL:

- Stern schwarzes glasfaserverstärktes Polyamid Fußkreuz, Ø 640 mm
- 5-Stern schwarzes glasfaserverstärktes Polyamid Fußkreuz, Ø 680 mm

6. ROLLEN:

- Ø 50 mm gebremste, oder weiche gebremste Rollen, schwarz
- Polyamidgleiter, H.61 mm, schwarz

7. ARMLEHNEN:

- schwarze, feste Polyamide Armlehne
- Verstellbare schwarze Polyamid Armlehne mit Polyamid Armauflage oder mit weiche Polyurethan Armauflage



84,4%

UNI 9084

EN 1335



D.Lgs 81

EN 13761

1 IM

EN9175

5 YEAR WARRANTY

UNI 9083

UNI 8591

EN 1728



Otavo

Cantilever



Otavo

Fissa, imbottita, struttura in metallo. Sedile e schienale tappezzati o sedile tappezzato e schienale in polipropilene nero.

Visitor, upholstered, metal structure. Upholstered seat and backrest or upholstered seat and black polypropylene backrest.

Visiteur, rembourré, structure en métal. Assise et dossier tapissée assise tapissée - dossier en polypropylène noir.

Besucher, gepolstert, Metallgestell. Sitz und Rückenl. gepolstert. Sitz gepol. mit schwarze Polypropylen Rückenlehne.



versions

Otavo
Cantilever



Otavo
4-legs





Otavo
Cantilever



Otavo
Cantilever

Otavo

4-legs



Otavo

4-legs





cantilever

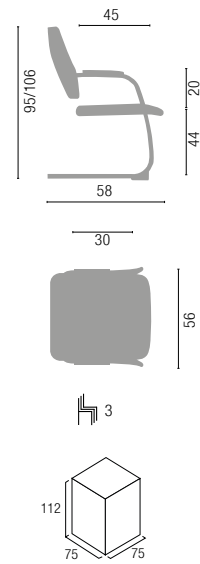

UNIT/PACK 3 - Kg 12,65 - m³ 0,5915

4-legs

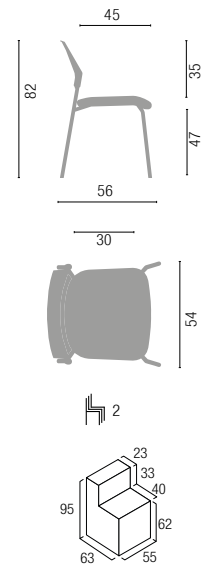

UNIT/PACK 2 - Kg 8,5 - m³ 0,5915



base



base a slitta con braccioli cromata
chromed cantilever base with arms
pièd. luge chromé avec acc.
Freischwinger Gestell verchromt mit Arml.

plugs



base 4 gambe vern. nera
4-legs black painted base
pièd. 4 pieds verni noir
4-Fuß Gestell schwarz lackiert

1. SCHIENALE:

Schienale in polipropilene, a vista o imbottito con spugna rivestito in tessuto

2. SEDILE:

Sedile in polipropilene imbottito con spugna, rivestita in tessuto

3. BASE:

- Base a slitta in tubo tondo d'acciaio, Ø25mm, finitura cromata
- Base 4 gambe in tubo tondo d'acciaio, Ø16mm, finitura verniciata a polveri

4. PIEDINI:

Tappi in polipropilene, finitura nera

1. BACKREST:

Polypropylene backrest, or foam padded and fabric upholstered

2. SEAT:

polypropylene seat, foam padded, fabric upholstery

3. BASE:

- Cantilever base, Ø 25mm steel tube, chromed finish
- 4 legs base, Ø 16 mm steel tube, powder coated

4. FEET:

Polypropylene plugs, black finish

1. DOSSIER:

Dossier en polypropylène à vue ou rembourrés de mousse et tapissée

2. ASSISE:

Assise en polypropylène rembourrée de mousse moulée à froids, tapissée

3. PIÈTEMENT:

- Piètement luge en tige d'acier Ø 16mm, finition chromé
- Piètement 4 pieds en tige d'acier Ø 16mm, finition verni époxy

4. PATINS:

Tampons en polypropylène, finition noir

1. RÜCKENLEHNE:

Polypropylen Rückenlehne, oder ausgepolstert mit Polyurethanschäum, mit Stoffbezug

2. SITZ:

Polypropylen Sitz, ausgepolstert mit kaltgeschäumten Polyurethan, mit Stoffbezug

3. GESTELL:

- Freischwinger Gestell, Ø 25mm Stahlrohr, verchromt (15µm)
- 4-Fuß Gestell, Ø16mm Stahlrohr, pulverbeschichtet

4. GLEITER:

Polyamid Gleiter, schwarz



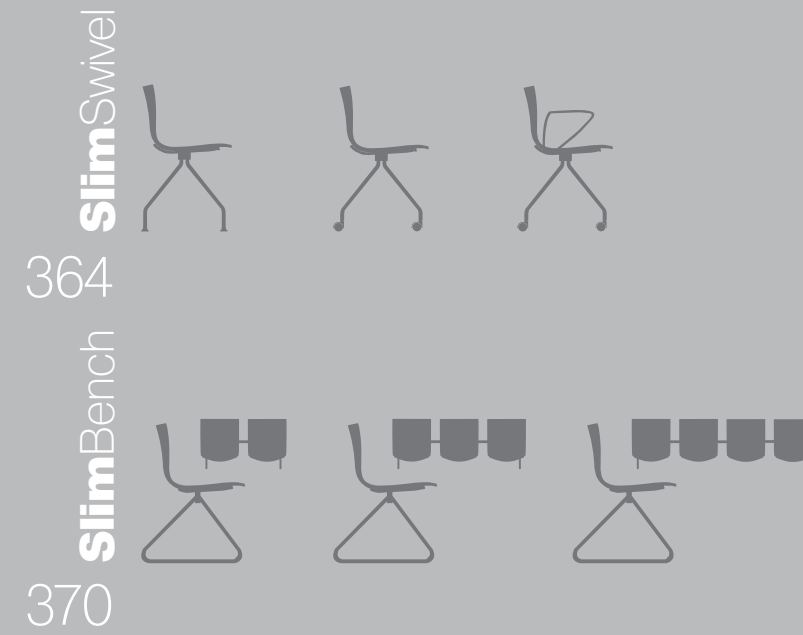
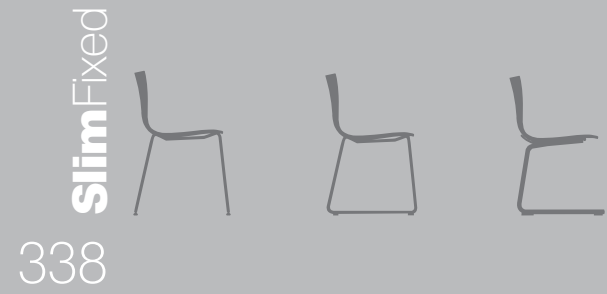

SLIM
collection

SLIM 325

Slim

design: AZ Creations



Engineering
Polymer Shell is
100%
recyclable

Caratterizzata da un design semplice, SLIM è una sedia che si adatta a diversi ambienti: dall'ufficio alla cucina, alla cameretta.

Quello che differenzia questa sedia dalle altre è l'innovativo materiale di cui è fatta: il polimero tecnico rende SLIM flessibile in modo intelligente e la sedia asseconda tutti i movimenti del corpo garantendo una posizione ergonomica. Inoltre il polimero tecnico è un materiale riciclabile al 100%. SLIM è disponibile con diverse opzioni presenti a listino riguardanti basi, braccioli e finiture.

Characterized by a simple design, SLIM fits well in different spaces: from the office, to the kitchen, to the bedroom.

The innovative material of which it is made is the main peculiarity that diversifies SLIM from the others chairs: the engineering polymer makes SLIM flexible in an intelligent way, by supporting all body movements in order to guarantee an ergonomic position.

Furthermore this engineering polymer is a 100% recyclable material. SLIM is available on different options as far as basements, armrests and finishings are concerned.

Caractérisée par un design simple, SLIM est une chaise qui s'adapte à plusieurs ambiances : du bureau à l'accueil, de la salle de réunion à la salle à manger. Ce qui fait la différence entre cette chaise et les autres est le matériel innovant dont elle est composée: le polymère technique rend la SLIM flexible de façon intelligente ; en effet la coque suit les mouvements du corps en permettant une position ergonomique. Encore, le polymère technique est un matériel 100% recyclable. SLIM est disponible en plusieurs options de structures, accoudoirs et finitions.

Gekennzeichnet durch sein einfaches Design, SLIM ist ein Stuhl geeignet für verschiedene Innenräume wie zum Beispiel: Büros, Konferenzen, Kantinen, Küchen und Schlafzimmer. Diese Stuhlfamilie unterscheidet sich von der anderen Stühle, für das innovative Material aus dem die Schale gemacht ist. Das verwendete technische Polymer Kunststoff macht den Slim flexibel in einer intelligenten Weise und der Stuhl folgt jede Bewegung des Körpers so dass eine ergonomische Haltung gewährleistet wird. Außerdem ist dieser technischen Polymer Kunststoff 100% recycelbar. Die Slim Schale ist in verschiedenen Farben lieferbar und kann aber auch nur mit Sitzkissen versehen sein oder voll ausgepolstert werden. Weitere Optionen wie Gestelle, Armlehnen und sonstige Oberflächen stehen zu Verfügung je nach Bedarf.



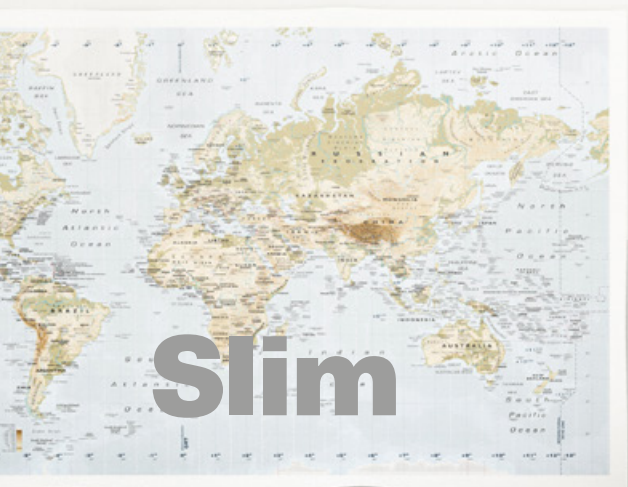

Slim



Slim

Task

Girevole, scocca in tecnopolimero, struttura in metallo. Con braccioli, tappezzata a fasce e tappezzata a fasce con braccioli.

Swivel, engineering polymer shell, metal structure. With armrest, stripe uphol. shell, stripe uphol. shell with armrest.

Pivotant, coque en polymère technique, structure en métal. Avec acc., tapissée en bandes, tapissée en bandes avec acc.

Drehbar, Technopolymer Schale, Metallgestell. Mit Arml., gepolst. mit Stepp., gepolst. mit Stepp. und Arml.

versions

Slim
Task
Aluminium base



Slim
Stool
Aluminium base



Slim
Task
Polyamide



Slim
Task



Slim
Task



Slim

Task



332 SLIM



Slim
Stool

SLIM 333

Slim
Stool





Slim
Task



aluminium
base

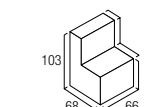
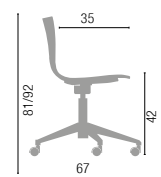

UNIT/PACK 1 - Kg 10,94 - m³ 0,4

aluminium
base armr.

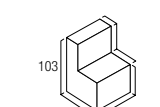
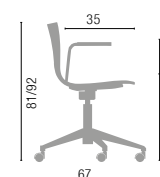

UNIT/PACK 1 - Kg 11,99 - m³ 0,4

aluminium
Stool

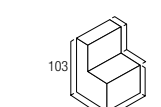
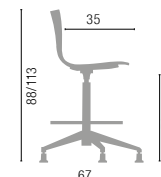

UNIT/PACK 1 - Kg 11,49 - m³ 0,4

polyamide

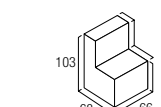
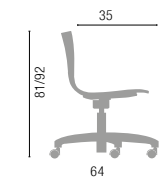

UNIT/PACK 1 - Kg 10,84 - m³ 0,4

polyamide
Tablet

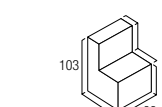
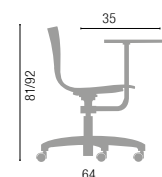

UNIT/PACK 1 - Kg 10,84 - m³ 0,4



technical data

mechanism

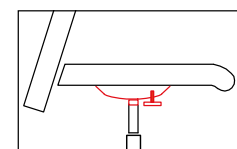

Piastra
Seat plate
Platine
Sitzplatte

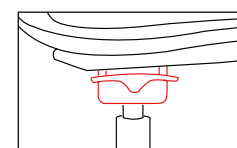

Meccanismo ErgoTek
ErgoTek Mechanism
Mécanisme ErgoTek
ErgoTek mechanik

base



Base 5 razze in alluminio lucida
5-spoke polished aluminium base
Piè. 5 branches alu poli
5-Stern Alu poliertes Fußkreuz



Base 5 razze poliamide nera
5-spoke black polyamide base
Piè. 5 branches polyam. noir
5-Stern schwarzes Design Fußkreuz

castors/feet



1. STRUTTURA:

Monoscocca in tecnopolimero, finitura RAL o imbottita con spugna e rivestita in tessuto, con struttura di sostegno in tubo tondo d'acciaio, Ø 16mm, con o senza braccioli, finitura cromata (15µm) o verniciata a polveri

2. MECCANISMO:

- Comando elevazione a gas, finitura nera
- ErgoTek, comando elevazione a gas, inclinazione in avanti scocca 5° in 1 posizione, inclinazione negativa 8° in 1 posizione
- Scrivitoio in stratificato HPL, finitura nera, con supporto in tubo d'acciaio Ø 25mm, finitura verniciata a polveri

3. BASE:

- Base 5 razze in alluminio, Ø 670mm, finitura lucida
- Base 5 razze in poliamide con carica di fibra di vetro, Ø 640mm, finitura nero

4. RUOTE/PIEDINI:

- Ruote Ø 50mm, autofrenanti o autofrenanti e gommate, finitura nera
- Piedini in poliamide, h. 61mm, finitura nera

5. BRACCIOLI:

Bracciolo triangolare in tondo d'acciaio, Ø 12mm, finitura cromata (15µm) o verniciata a polveri (imbottito e rivestito in tessuto)

1. STRUCTURE:

Engineering polimer monocoque, ral finish or foam padded and upholstered. Round steel bar structure Ø16mm, with or whitout armrests, chromed finish (15µm) or powder coated

2. MECHANISM:

- Height adjustable, Black finish
- ErgoTek, gas lift height adj. Coque 5° grade 1 position, negative grade 8° 1 position
- Hpl multilayer writing tablet, black finish, steel tube Ø25mm structure, powder coated

3. BASE:

- Polished aluminium 5 spoke base, Ø670 mm
- Fiberglass reinforced polyamide 5 spoke base, Ø640 mm, black finish

4. CASTORS/FEET:

- Ø 50 mm self-braking castors, or soft self-bracking. Black finish
- h.61 mm polyamide glides, black finish

5. ARMREST:

Steel round bar Ø12 mm, triangular armrest, chromed finish(15µm) or powder coated. Padded and fabric upholstered

1. STRUCTURE:

Monocoque en polymère technique, finition RAL ou rembourrée de mousse et tapissée. Structure de support en tube d'acier, Ø16mm, avec ou sans accoudoirs, finition chromé (15µm) o verni époxy

2. MECANISME:

- Réglable en hauteur, finition noir
- Réglable en hauteur, pivotant, finition chromé, tabouret
- Tablette en stratifié HPL, finition noir, support en tube d'acier Ø 25mm, finition verni époxy

3. PIÈTEMENT:

- Piètement 5 branches alu poli, Ø 670mm
- Piètement 5 branches en polyamide renforcé en fibre de verre, Ø640mm, finition noir

4. ROULETTES/PATINS:

- Roulettes Ø 50mm, autofreinantes ou autofreinantes et gommées, finition chromé ou noir
- Patins en polyamide, h.61mm, finition noir

5. ACCOUDOIR:

Accoudoir triangulaire en tige d'acier, Ø 12mm, finition chromé (15µm) ou verni époxy (manchette rembourrée et tapissée)

1. STRUKTUR:

Technopolymer Schale, RAL Farben oder ausgepolstert mit Schwamm und Stoffbezug, Rund-Stahlrohrgestell Ø 16 mm, mit oder ohne Armlehnen, verchromt (15 µm) oder pulverbeschichtet

2. MECHANIK:

- Sitzhöhenverstellung, drehbar, verchromt
- Hocker Sitzhöhenverstellung, drehbar, verchromt
- HPL geschichtete Schreibplatte, schwarz, mit Stahlrohrträger Ø 25 mm, verchromt oder pulverbeschichtet

3. GESTELL:

- 5-Stern Alu poliertes Fußkreuz, Ø 670 mm
- 5-Stern schwarzes glasfaserverstärktes Polyamid Fußkreuz, Ø640 mm

4. ROLLEN/GLEITER:

- Ø 50 mm gebremste, oder weiche gebremste Rollen, schwarz oder verchromt
- Polyamidgleiter, H.61 mm, schwarz

5. ARMLEHNE:

Feste dreieckige Armlehne aus Stahlstab, Ø 12 mm, verchromt (15 µm) oder pulverbeschichtet, ausgepolstert mit Stoffbezug

ErgoTek

La sedia Slim con meccanismo ErgoTek ti accompagna per tutto il giorno, assicurandoti di essere sempre seduto nella giusta postura.

ErgoTek è un meccanismo di inclinazione, che fornisce l'inclinazione del guscio in avanti e indietro, con un sistema di bloccaggio all'indietro. Gli istituti di CATAS e FIRA hanno collaborato insieme per testare il sedile equipaggiato con i meccanismi ErgoTek, aggiudicandolo con il 1° CERTIFICATO ERGONOMICO (EN 9241).

The Slim chair with ErgoTek mechanism accompanies you throughout the day, ensuring you are always seated in the right posture. ErgoTek is a tilting mechanism, which provides the shell inclination forward and backward, with a backward locking system. The institutes of CATAS and FIRA have collaborated together to test the seat equipped with the ErgoTek mechanism, awarding it with the 1st ERGONOMICS CERTIFICATE (EN 9241).

La chaise Slim avec mécanisme ErgoTek vous accompagne tout au long de la journée, vous assurant ainsi d'être toujours assis dans la bonne posture. ErgoTek est un mécanisme de basculement, qui fournit l'inclinaison de la coque vers l'avant et vers l'arrière, avec un système de verrouillage vers l'arrière. Les instituts du CATAS et de la FIRA ont collaboré pour tester le siège équipé du mécanisme ErgoTek, en lui décernant le 1er CERTIFICAT ERGONOMIQUE (EN 9241).

Der Slim-Stuhl mit ErgoTek-Mechanismus begleitet Sie den ganzen Tag, damit Sie immer in der richtigen Körperhaltung sitzen. ErgoTek ist ein Kippmechanismus, der die Schalenneigung vorwärts und rückwärts mit einem Rückwärtsverriegelungssystem bereitstellt. Die Institute von CATAS und FIRA haben gemeinsam den mit den ErgoTek Mechanis ausgerüsteten Sitz getestet und mit dem ERGONOMICS CERTIFICATE (EN 9241) ausgezeichnet.



Elevazione a gas
Chair height adjustment
Réglable en hauteur
Sitzhöhenverstellung



Inclinazione sedile
Negative seat inclination
Inclinaison négative de l'assise
Sitznaigung



Blocco-sblocco oscillazione
Locking-unlocking device
of the coque oscillation
Blocage-déblocage
basculant de la coque
Blockierungssystem der
Rückenlehne



100 %

EN 1335

EN 1022

EN 1728

EN 16139

EN 9175

5 YEAR WARRANTY

CATAS

MEMBER

CERTIFICATION and guarantee of absolute product quality

ISO 9001:2008

ISO 14001:2004

Environmental

ISO 45001:2018

Safety

ISO 11112:2006

Environmental

ISO 14001:2004

Environmental

ISO 45001:2018

Safety

ISO 11112:2006

Environmental

ISO 14001:2004

Environmental

ISO 45001:2018

Safety

ISO 11112:2006

Environmental

ISO 14001:2004

Environmental

ISO 45001:2018

Safety

ISO 11112:2006

Environmental

ISO 14001:2004

Environmental

ISO 45001:2018

Safety

ISO 11112:2006

Environmental

ISO 14001:2004

Environmental

ISO 45001:2018

Safety

ISO 11112:2006

Environmental

ISO 14001:2004

Environmental

ISO 45001:2018

Safety

ISO 11112:2006

Environmental

ISO 14001:2004

Environmental

ISO 45001:2018

Safety

ISO 11112:2006

Environmental

ISO 14001:2004

Environmental

ISO 45001:2018

Safety

ISO 11112:2006

Environmental

ISO 14001:2004

Environmental

ISO 45001:2018

Safety

ISO 11112:2006

Environmental

ISO 14001:2004

Environmental

ISO 45001:2018

Safety

ISO 11112:2006

Environmental

ISO 14001:2004

Environmental

ISO 45001:2018

Safety

ISO 11112:2006

Environmental

ISO 14001:2004

Environmental

ISO 45001:2018

Safety

ISO 11112:2006

Environmental

ISO 14001:2004

Environmental

ISO 45001:2018

Safety

ISO 11112:2006

Environmental

ISO 14001:2004

Environmental

ISO 45001:2018

Safety

ISO 11112:2006

Environmental

ISO 14001:2004

Environmental

ISO 45001:2018

Safety

ISO 11112:2006

Environmental

ISO 14001:2004

Environmental

ISO 45001:2018

Safety

ISO 11112:2006

Environmental

ISO 14001:2004

Environmental

ISO 45001:2018

Safety

ISO 11112:2006

Environmental

ISO 14001:2004

Environmental

ISO 45001:2018

Safety

ISO 11112:2006

Environmental

ISO 14001:2004

Environmental

ISO 45001:2018

Safety

ISO 11112:2006

Environmental

ISO 14001:2004

Environmental

ISO 45001:2018

Safety

ISO 11112:2006

Environmental

ISO 14001:2004

Environmental

ISO 45001:2018

Safety

ISO 11112:2006

Environmental

Slim

Task

options

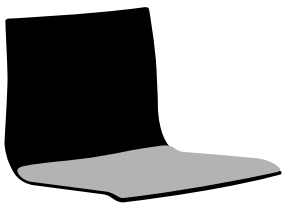

XC017 - cushion

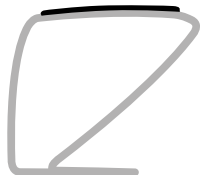

XB030 - chromed
XB026 - white
XB035 - black

XB040 - chromed, uph. pad
XB039 - white, uph. pad
XB042 - black, uph. pad

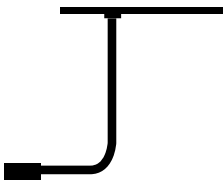

XS002
 school writing tablet

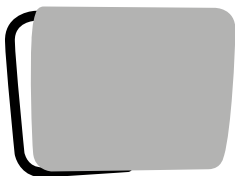

XS003
 writing tablet



XP001
 footrest ring
 for high gas version only



Slim

Fixed

Fissa, scocca in tecnopolimero, struttura in metallo. Tappezzata a fasce e tappezzata a fasce con braccioli.

Visitor, engineering polymer shell, metal structure. Stripe uphol. shell, stripe uphol. shell with armrest.

Visiteur, coque en polymère technique, structure en métal. Tapissée en bandes, tapissée en bandes avec acc.

Besucher, Technopolymer Schale, Metallgestell. Gepolst. mit Stepp., gepolst. mit Stepp. und Arml.



versions

Slim
4-legs



Slim
Sled base



Slim
Reverse
cantilever

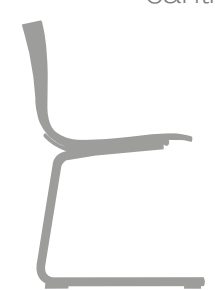

340 SLIM

Slim
4-legs



SLIM 341

Slim
4-legs



Slim

4-legs



Slim

4-legs

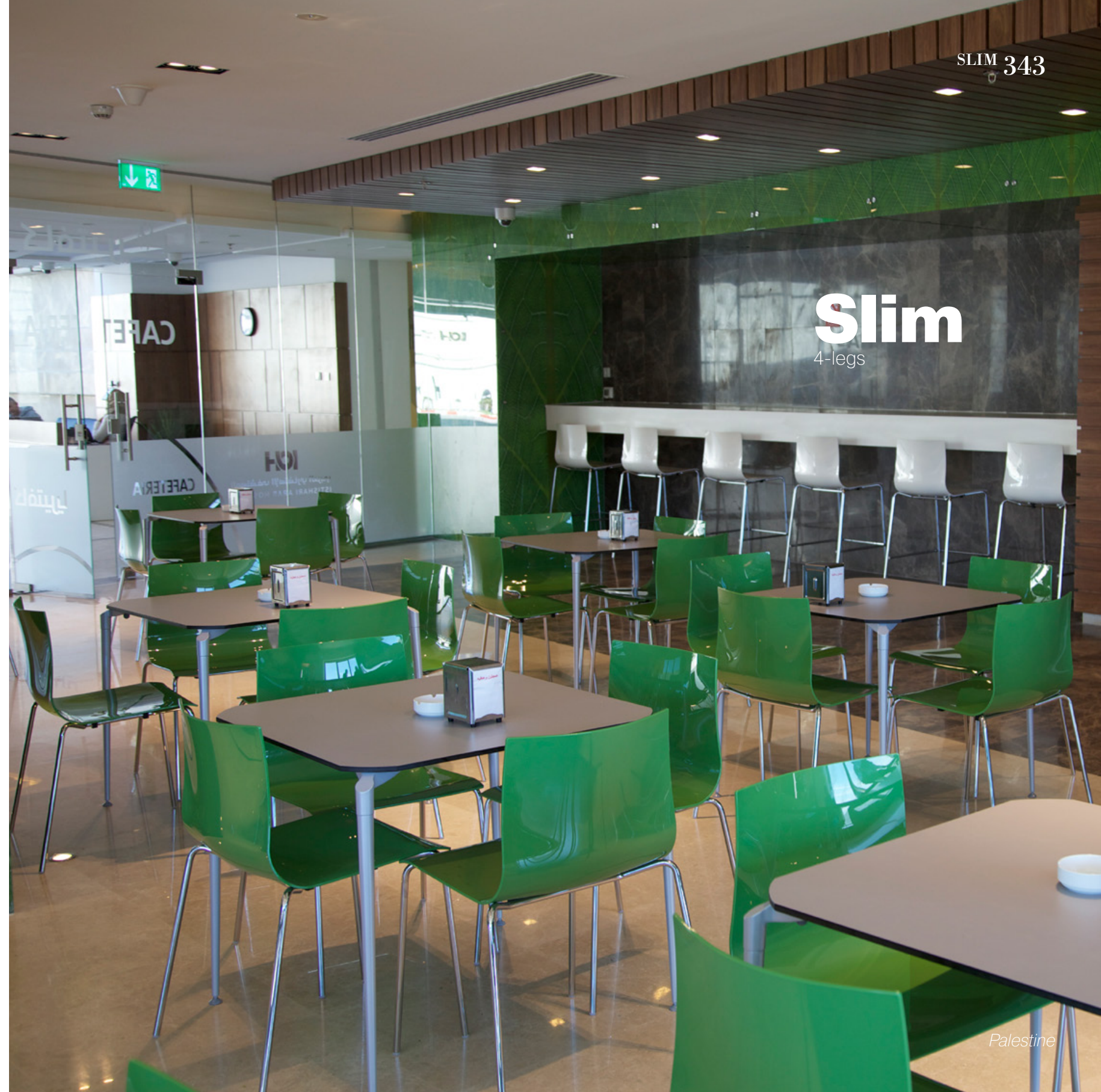



Slim

4-legs

France



Slim

4-legs

346 SLIM

Slim
4-legs



SLIM 347

Slim
4-legs / Trolley



348 SLIM

Slim
Sled base



SLIM 349

Slim



350 SLIM

Slim
Sled base

Iceland

SLIM 351

Slim
Sled base



Slim
Reverse Cantilever



Slim
Reverse Cantilever





Slim
4-legs



4-legs

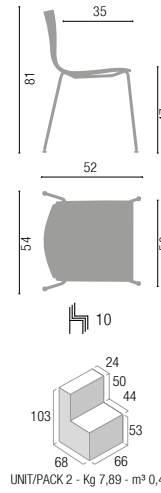

4-legs arm.

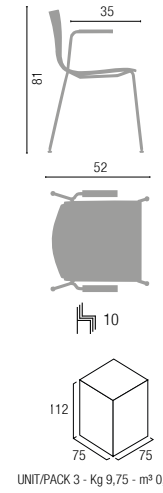

Slim
Sled base



sled base

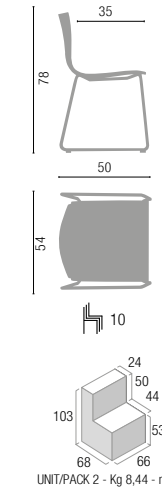

sled base arm.

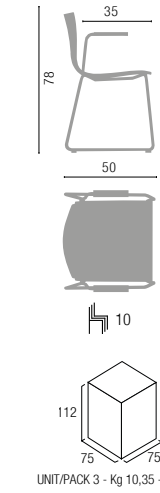

technical data

technical data

options

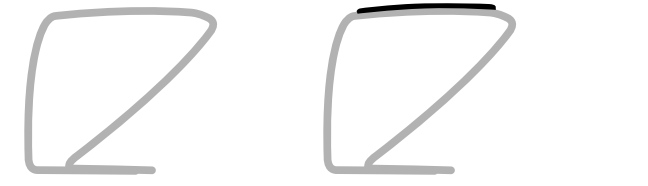

XB030 - chromed
XB026 - white
XB035 - black
XB040 - chromed, uph. pad
XB039 - white, uph. pad
XB042 - black, uph. pad

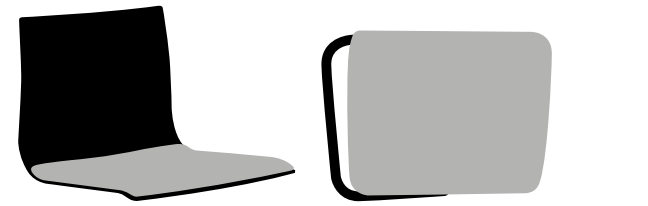

XC017 - cushion
XS003 - writing tablet

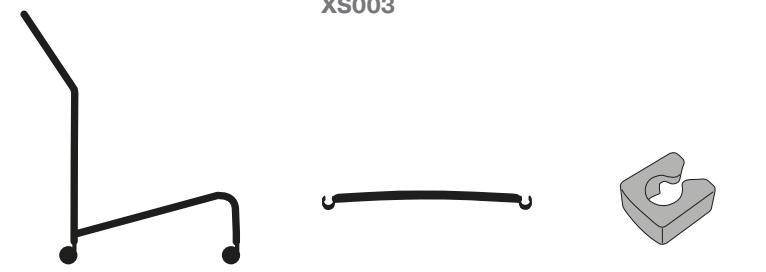

trolley **XA009**
linking device **XA001** - seat
XA002 - armrest
stacking device **XA007**

base



Base 4 gambe vern. nera, bianca, cromata
4-legs black, white painted or chromed base
Piè. 4 pieds verni noir, blanc ou chromé
4-Fuß Gestell schwarz, weiss lackiert oder verchromt



Base 4 gambe con braccioli vern. nera, bianca, cromata
4-legs black, white painted or chromed base with arms
Piè. 4 pieds verni noir, blanc ou chromé avec acc.
4-Fuß Gestell schwarz, weiss lackiert oder verchromt mit Arml.

feet



options

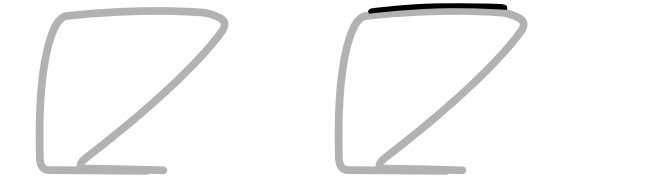

XB030 - chromed
XB026 - white
XB035 - black
XB040 - chromed, uph. pad
XB039 - white, uph. pad
XB042 - black, uph. pad

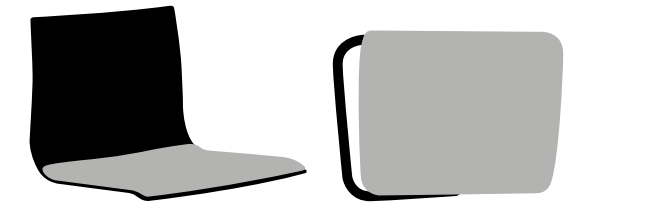

XC017 - cushion
XS003 - writing tablet

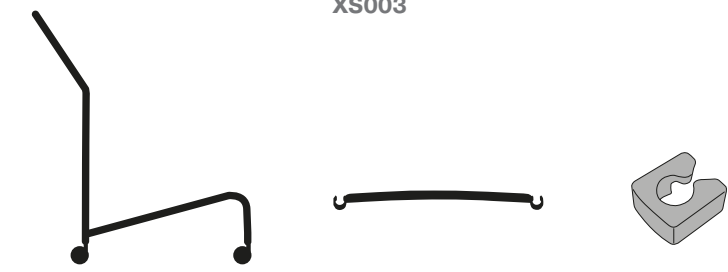

trolley **XA009**
linking device **XA001** - seat
XA002 - armrest
stacking device **XA007**

base



Base a slitta vern. nera, bianca, cromata
Black, white painted or chromed sled base
Piè. luge verni noir, blanc ou chromé
Kufengestell schwarz, weiss lackiert oder verchromt



Base 4 gambe con braccioli vern. nera, bianca, cromata
4-legs black, white painted or chromed base with arms
Piè. 4 pieds verni noir, blanc ou chromé avec acc.
4-Fuß Gestell schwarz, weiss lackiert oder verchromt mit Arml.

feet



technical data

Slim
Reverse Cantilever



reverse cantilever

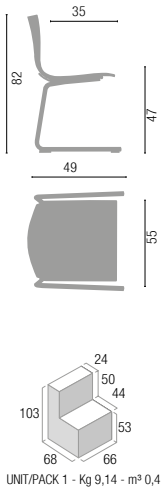

options

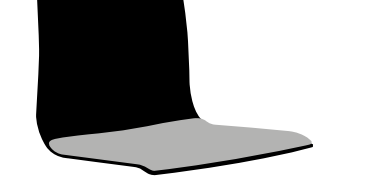

XC017 - cushion

base



Base mensa vern. nera, bianca, cromata
Chromed, black or white painted reverse cantilever base
Piè. appui sur table verni noir, blanc, chromé
C-Gestell schwarz, weiss, lackiert oder verchromt

feet



Slim

4-legs
Sled base
Reverse Cantilever



1. STRUTTURA:

Monoscocca in tecnopolimero, finitura RAL o imbottita con spugna e rivestita in tessuto, con struttura di sostegno in tubo tondo d'acciaio, Ø 16mm, con o senza braccioli, finitura cromata (15µm) o verniciata a polveri

2. BASE:

- Base 4 gambe in tubo d'acciaio Ø 16mm, con o senza braccioli, finitura cromata (15µm) o verniciata a polveri
- Base a slitta in tubo d'acciaio Ø 16mm, con o senza braccioli, finitura cromata (15µm) o verniciata a polveri
- Base mensa in tubo d'acciaio Ø 20mm, finitura cromata (15µm) o verniciata a polveri

3. PIEDINI:

- Piedini snodati in poliamide, finitura cromata (15µm), nera o bianca
- Tappi in polipropilene, finitura nera o bianca
- Tappi antiribaltamento in poliamide, finitura nera

4. BRACCIOLI:

Bracciolo triangolare in tondo d'acciaio, Ø 12mm, finitura cromata (15µm) o verniciata a polveri (imbottito e rivestito in tessuto)

1. STRUCTURE:

Engineering polimer monocoque, ral finish or foam padded and upholstered. Round steel bar structure Ø16mm, with or without armrests, chromed finish (15µm) or powder coated

2. BASE:

- 4 legs base, Ø 16 mm steel tube, with or without armrest, chromed finish (15µm) or powder coated
- Cantilever base, Ø 16 mm steel tube, with or without armrest, chromed finish (15µm) or powder coated
- Reverse cantilever base Ø 20mm steel tube, chromed finish (15µm) or powder coated

3. FEET:

- Leveler glides in polyamide, chromed finishes (15µm), black or white
- polypropylene plugs, black or white finish
- polyamide anti overturning plugs, black finish

4. ARMREST:

Steel round bar Ø12 mm, triangular armrest, chromed finish(15µm) or powder coated. Padded and fabric upholstered

1. STRUCTURE:

Monocoque en polymère technique, finition RAL ou rembourrée de mousse et tapissée. Structure de support en tube d'acier, Ø 16mm, avec ou sans accoudoirs, finition chromé (15µm) o verni époxy

2. PIETEMENT:

- Piètement 4 pieds en tube d'acier Ø 16mm, avec ou sans accoudoirs, finition chromé (15µm) ou verni époxy
- Piètement luge en tube d'acier Ø 16mm, avec ou sans accoudoirs, finition chromé (15µm) ou verni époxy
- Piètement luge inversé en tube d'acier Ø 20mm, finition chromé (15µm) o verni époxy

3. PATINS:

- Patins articulés et polyamide, finition chromée (15µm), noir ou blanc
- Tampons en polypropylène, finition noir ou blanc
- Tampons anti renversement en polyamide, finition noir

4. ACCOUDOIR:

Accoudoir triangulaire en tige d'acier, Ø 12mm, finition chromé (15µm) ou verni époxy (manchette rembourrée et tapissée)

1. STRUKTUR:

Technopolymer Schale, RAL Farben oder ausgepolstert mit Schwamm und Stoffbezug, Rund-Stahlrohrgestell Ø 16 mm, mit oder ohne Armlehnen, verchromt (15 µm) oder pulverbeschichtet

2. GESTELL:

- 4-Fuß Gestell, Ø 16mm Stahlrohr, mit oder ohne Arml. verchromt (15µm) oder pulverbeschichtet
- Kufengestell, Ø 16mm Stahlrohr, mit oder ohne Arml. verchromt (15µm) oder pulverbeschichtet
- C-Gestell, Ø20mm Stahlrohr, verchromt (15µm) oder pulverbeschichte

3. GLEITER:

- Gelenkgleiter aus Polyamid, verchromt (15 µm), schwarz oder weiss
- polyamid gleiter, schwarze oder weisse
- Schwarze Polyamid Antirollgleiter

4. ARMLEHNE:

Feste dreieckige Armlehne aus Stahlstab, Ø 12 mm, verchromt (15µm) oder pulverbeschichtet, ausgepolstert mit Stoffbezug



ID 1111209613

Slim

Stool



Lithuania



Slim

Stool

Fissa, scocca in tecnopolimero, struttura in metallo. Tappezzata a fasce e tappezzata a fasce con braccioli.

Visitor, engineering polymer shell, metal structure. Stripe uphol. shell, stripe uphol. shell with armrest.

Visiteur, coque en polymère technique, structure en métal. Tapissée en bandes, tapissée en bandes avec acc.

Besucher, Technopolymer Schale, Metallgestell. Gepolst. mit Stepp., gepolst. mit Stepp. und Arml.

versions

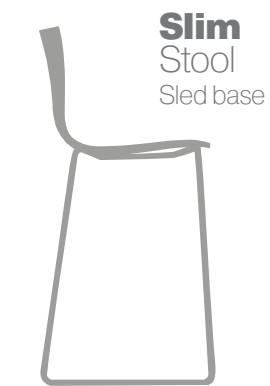

360 SLIM

Slim

Stool



SLIM 361

Slim

Stool



Slim

Stool



Slim

Stool



stool
4-legs

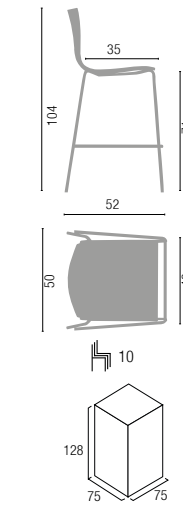

UNIT/PACK 4 - Kg 11,5 - m³ 0,6928

stool
sled base

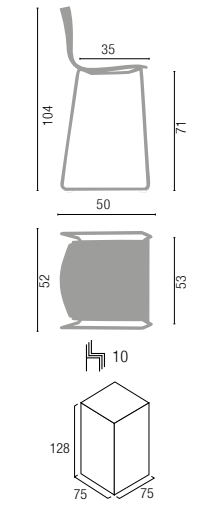

UNIT/PACK 4 - Kg 11 - m³ 0,6928

technical data

options

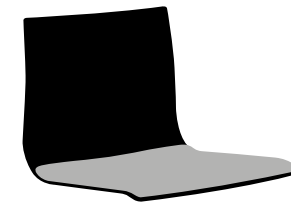

XC017 - cushion

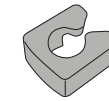

stacking device
XA007



Base 4 gambe vern. nera, bianca, crom.
Black, white painted or chromed 4-legs stool base
4-pieds tabouret verni noir, blanc ou chromé
Hocker 4-Fuß Gestell schwarz, weiss lackiert oder
verchromt



base

Base sgabello slitta vern. nera, bianca, crom.
Black, white painted or chromed stool sled base
Pièd. luge tabouret verni noir, blanc ou chromé
Hocker Kufengestell schwarz, weiss lackiert
oder verchromt

castors



1. STRUTTURA: Monoscocca in tecnopolimero, finitura RAL o imbottita con spugna e rivestita in tessuto, con struttura di sostegno in tubo tondo d'acciaio, Ø 16mm, con o senza braccioli, finitura cromata (15µm) o verniciata a polveri
2. BASE:
• Base 4 gambe sgabello in tubo d'acciaio Ø 16mm, finitura cromata (15µm) o verniciata a polveri
• Base a slitta sgabello in tubo d'acciaio Ø 16mm, finitura cromata (15µm) o verniciata a polveri
3. PIEDINI: Tappi in polipropilene, fin. nera o bianca
4. BRACCIOLI: Bracciolo triangolare in tondo d'acciaio, Ø 12mm, finitura cromata (15µm) o verniciata a polveri (imbottito e rivestito in tessuto)

1. STRUCTURE: Engineering polimer monocoque, ral finish or foam padded and upholstered. Round steel bar structure Ø16mm, with or without armrests, chromed finish (15µm) or powder coated
2. BASE:
• 4 legs stool base, Ø 16 mm steel tube, chromed finish (15µm) or powder coated
• Cantilever stool base, Ø 16 mm steel tube, chromed finish (15µm) or powder coated
3. FEET: Polypropylene plugs, black or white finish
4. ARMREST: Steel round bar Ø12 mm, triangular armrest, chromed finish (15µm) or powder coated. Padded and fabric upholstered

1. STRUCTURE: Monocoque en polymère technique, finition RAL ou rembourrée de mousse et tapissée. Structure de support en tube d'acier, Ø16mm, avec ou sans accoudoirs, finition chromé (15µm) o verni époxy
2. PIÈTEMENT:
• Piètement 4 pieds tabouret en tube d'acier Ø 16mm, finition chromé (15µm) ou verni époxy
• Piètement luge tabouret en tube d'acier Ø 16mm, finition chromé (15µm) ou verni époxy
3. PATINS: Tampons en polypropylène, finition noir ou blanc
4. ACCOUDOIR: Accoudoir triangulaire en tige d'acier, Ø 12mm, finition chromé (15µm) ou verni époxy (manchette rembourrée et tapissée)

1. STRUKTUR: Technopolimer Schale, RAL Farben oder ausgepolstert mit Schwamm und Stoffbezug, Rund-Stahlrohrgestell Ø 16 mm, mit oder ohne Armlehnen, verchromt (15 µm) oder pulverbeschichtet
2. GESTELL:
• 4-Fuß Hocker Gestell, Ø 16mm Stahlrohr, mit oder ohne Arml. verchromt (15µm) oder pulverbeschichtet
• Hocker Kufengestell, Ø 16mm Stahlrohr verchromt (15µm) oder pulverbeschichtet
3. GLEITER: Polyamid gleiter, schwarze oder weisse
4. ARMLEHNE: Feste dreieckige Armlehne aus Stahlstab, Ø 12 mm, verchromt (15 µm) oder pulverbeschichtet, ausgepolstert mit Stoffbezug



ID 1111209613



Slim

Swivel

Girevole, scocca in tecnopolimero, struttura in metallo. Con braccioli, tappezzata a fasce e tappezzata a fasce con braccioli.

Swivel, engineering polymer shell, metal structure. With armrest, stripe uphol. shell, stripe uphol. shell with armrest.

Pivotant, coque en polymère technique, structure en métal. Avec acc., tapissée en bandes, tapissée en bandes avec acc.

Drehbar, Technopolymer Schale, Metallgestell. Mit Arml., gepolst. mit Stepp., gepolst. mit Stepp. und Arml.

versions

Slim
Swivel



Slim
Swivel
Castors



Slim
Swivel
Castors with arms

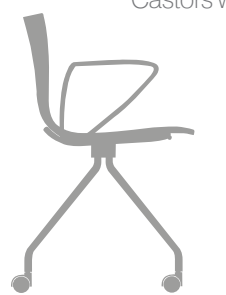

Slim
Swivel



Slim
Swivel





Slim

Swivel

France

SLIM
collection

Slim

Swivel



swivel

swivel
arm.

swivel
castors arm.

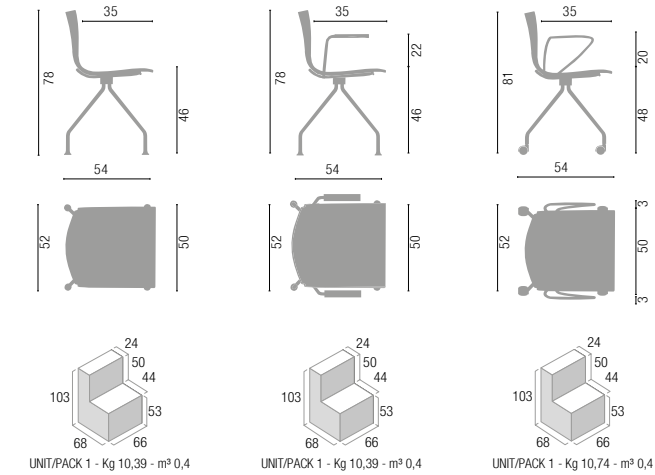

technical data

options

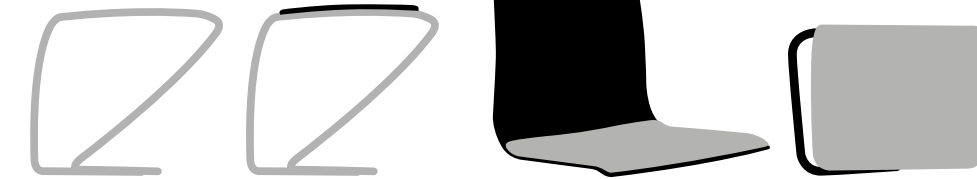

XB030 - chromed
XB026 - white
XB035 - black

XB040 - chromed, uph. pad
XB039 - white, uph. pad
XB042 - black, uph. pad

XC017 - cushion

XS003
writing tablet

base



Base ragno vern. nera, bianca, cromata
White painted or chromed swivel base pièt
4 pieds pivot verni noir, blanc ou chromé
4-Fuß Drehkreuz schwarz, weiss lackiert
oder verchromt

castors/feet



1. STRUTTURA: Monoscocca in tecnopolimero, finitura RAL o imbottita con spugna e rivestita in tessuto, con struttura di sostegno in tubo tondo d'acciaio, Ø16mm, con o senza braccioli, finitura cromata (15µm) o verniciata a polveri
2. BASE: Base 4 gambe a ragno in tubo d'acciaio Ø20mm, finitura cromata (15µm) o verniciata a polveri
3. RUOTE/PIEDINI:
• Ruote Ø50mm, autofrenanti o autofrenanti e gommate, finitura cromata o nera
• Piedini in polimero termoplastico, h. 68mm, finitura cromata (15µm) o nera
4. BRACCIOLI: Bracciolo triangolare in tondo d'acciaio, Ø12mm, finitura cromata (15µm) o verniciata a polveri (imbottito e rivestito in tessuto)

1. STRUCTURE: Engineering polimer monocoque, ral finish or foam padded and upholstered. Round steel bar structure Ø16mm, with or without armrests, chromed finish (15µm) or powder coated
2. BASE: 4 legs swivel base, Ø22 mm steel tube, chromed finish (15µm) or powder coated
3. CASTORS/FEET:
• Ø50 mm self-braking castors, or soft self-bracking. Black or Chromed finish
• h.68mm Termoplastic polimer gliders chromed (15µm) or black finish
4. ARMREST: Steel round bar Ø12 mm, triangular armrest, chromed finish (15µm) or powder coated. Padded and fabric upholstered

1. STRUCTURE: Monocoque en polymère technique, finition RAL ou rembourrée de mousse et tapissée. Structure de support en tube d'acier, Ø16mm, avec ou sans accoudoirs, finition chromé (15µm) ou verni époxy
2. PIÈTEMENT: Piètement araigné 4 pieds en tube d'acier Ø20mm, finition chromé (15µm) ou verni époxy
3. ROULETTES/PATINS:
• Roulettes Ø50mm, autofreinantes ou autofreinantes et gommées, finition chromé ou noir
• Patins en polymère thermoplastique, h.68mm, finition chromée (15µm) ou noir
4. ACCOUDOIR: Accoudoir triangulaire en tige d'acier, Ø12mm, finition chromé (15µm) ou verni époxy (manchette rembourrée et tapissée)

1. STRUKTUR: Technopolymere Schale, RAL Farben oder ausgepolstert mit Schwamm und Stoffbezug, Rund-Stahlrohrgestell Ø16 mm, mit oder ohne Armlehnen, verchromt (15µm) oder pulverbeschichtet
2. GESTELL: 4-Fuß Drehkreuz, Ø20 mm Stahlrohr, verchromt (15µm) oder pulverbeschichtet
3. ROLLEN/GLEITER:
• Ø50 mm gebremste, oder weiche gebremste Rollen, schwarz oder verchromt
• Thermoplastische Polymergleiter, H.68 mm verchromt (15µm) oder schwarz
4. ARMLEHNE: Feste dreieckige Armlehne aus Stahlstab, Ø12 mm, verchromt (15µm) oder pulverbeschichtet, ausgepolstert mit Stoffbezug



ID 1111209613

370 SLIM

SLIM 371

Slim
Bench



Slim

Bench



Slim

Bench

Fissa, scocca in tecnopolimero, struttura in metallo. Tappezzata a fasce. 2-4 posti.

Visitor, engineering polymer shell, metal structure. Stripe uphol. shell. 2-4 seats.

Visiteur, coque en polymère technique, structure en métal. Tapissée en bandes. 2-4 places.

Besucher, Technopolymer Schale, Metallgestell. Gepolst. mit Stepp. 2-4 sitz.

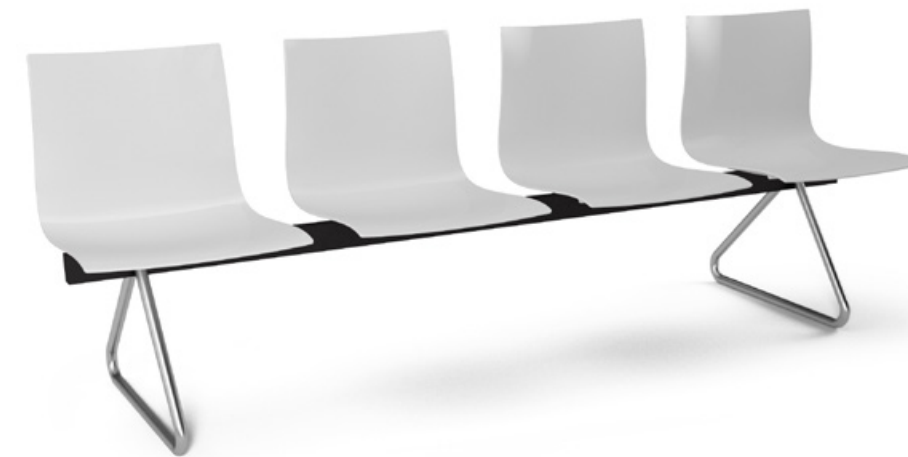

versions

Slim
Bench /2

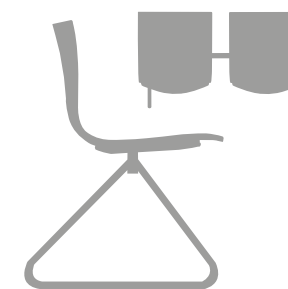

Slim
Bench /3

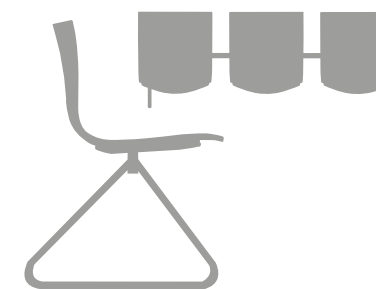

Slim
Bench /4

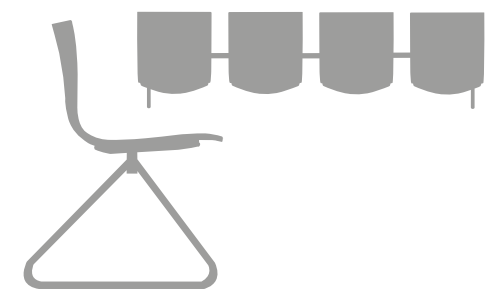

Slim

Bench



Slim

Bench

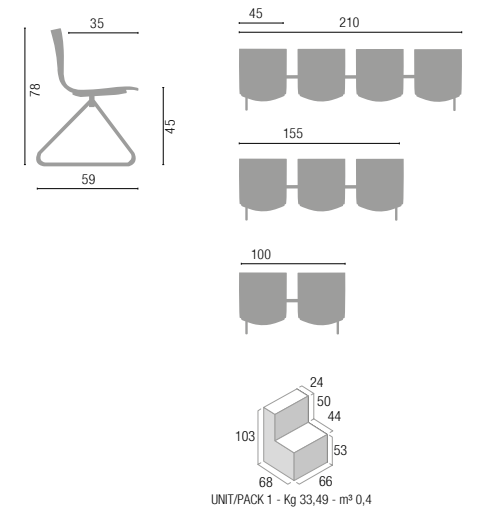
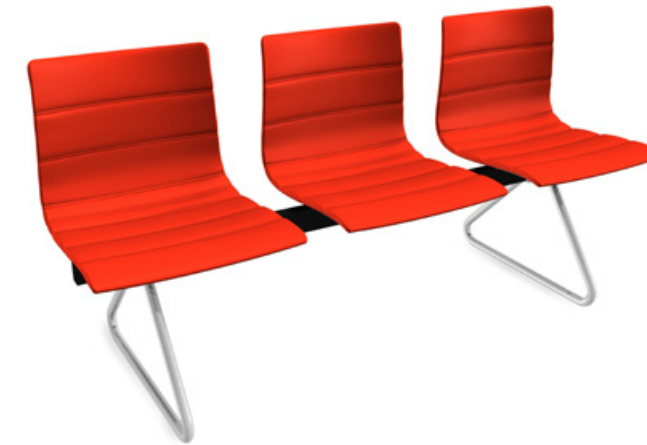

technical data

options

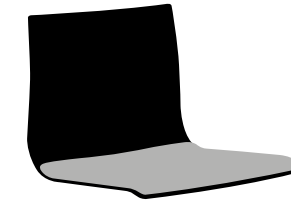

XC017 - cushion

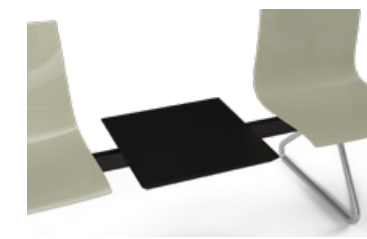

table

base



Trave vern. nera con gambe vern. nere, bianche o cromate
Black painted bench, black, white or chromed painted frame
Poutre vernie noire avec pièd. verni noir, blanc ou chromé
Sitzträger schwarz lack., Fußße. schwarz, weiss lackiert oder verchromt

1. STRUTTURA:

Trave 2/3/4 posti con monoscocca in tecnopolimero, finitura RAL o imbottita con spugna e rivestita in tessuto, con struttura di sostegno in tubo tondo d'acciaio, Ø16mm, finitura cromata (15µm) o verniciata a polveri (tavolino in lamina d'acciaio, finitura verniciata a polveri)

2. BASE:

Trave in tubo rettangolare d'acciaio 60x20mm, finitura verniciata a polveri con gambe in tubo d'acciaio Ø20mm, finitura cromata (15µm) o verniciata a polveri

3. BRACCIOLI:

Bracciolo triangolare in tondo d'acciaio, Ø12mm, finitura cromata (15µm) o verniciata a polveri (imbottito e rivestito in tessuto)

1. STRUCTURE:

2/3/4 seats bench, with Engineering polymer monocoque, ral finish or foam padded and upholstered. Round steel bar structure Ø16mm, with or without armrests, chromed finish (15µm) or powder coated. (metal sheet coffee table, powder coated)

2. BASE:

Rect. Steel tube bar 60x20mm, powder coated, with steel tube legs Ø20mm, chromed finish (15µm) or powder coated

3. ARMREST:

Steel round bar Ø12 mm, triangular armrest, chromed finish (15µm) or powder coated. Padded and fabric upholstered

1. STRUCTURE:

Poutre 2/3/4 places avec monocoque en polymère technique, finition RAL ou rembourrée de mousse et tapissée. Structure de support en tube d'acier, Ø16mm, finition chromé (15µm) o verni époxy (tablette en acier, finition verni époxy)

2. PIÈTEMENT:

Poutre en tube d'acier rectangulaire, 60x20mm, finition verni époxy avec pieds en tube d'acier Ø20mm, finition chromé (15µm) ou verni époxy

3. ACCOUDOIR:

Accoudoir triangulaire en tige d'acier, Ø12mm, finition chromé (15µm) ou verni époxy (manchette rembourrée et tapissée)

1. STRUKTUR:

2/3/4 Sitz Stahlbalken, mit Technopolymer Schale, Ral Farben oder ausgepolster mit Schwamm und Stoffbezug, Rund-Stahlrohrgestell Ø16 mm, verchromt (15µm) oder pulverbeschichtet. (Stahlband-Ablageplatte, pulverbeschichtet)

2. GESTELL:

Rechteckige Stahlrohrrbalken, 60x20 mm, pulverbeschichtet mit Stahlrohrbeine, Ø20 mm, verchromt 15 µm) oder pulverbeschichtet

3. ARMLEHNE:

Feste dreieckige Armlehne aus Stahlstab, Ø12 mm, verchromt (15 µm) oder pulverbeschichtet, ausgepolstert mit Stoffbezug



ID 1111209613



Arturo

380



Modulo

388



Giunone

396



Elettra

404



Cardinale

410

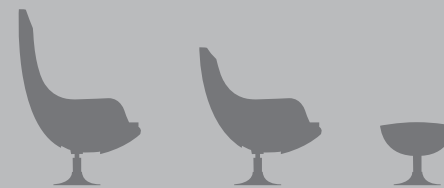

Carmen

420





428 **Tosca**



436 **Boheme**

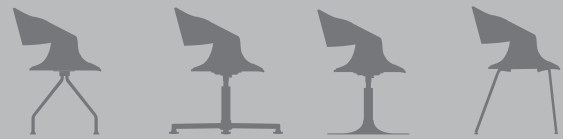

448 **Aida**



458 **Zaira**

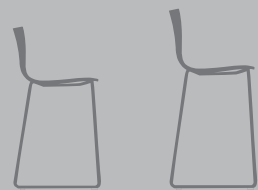

466 **Edgar**



472 **Nabucco**



478 **Otello**



BUS
INE
SS collection

Arturo

design: AZ Creations

Ampio e lineare ma anche essenziale ed elegante, realizzato con materiali pregiati che insieme armonizzano l'ambiente dove sarà posizionato, ARTURO, proposto a uno, due e tre posti, svela il segreto di uno stile che ha puntato sull'accuratezza, tradotta con l'utilizzo sapiente di materiali di altissima qualità, con il livello di rifiniture e con l'attenzione ai dettagli.

Wide and linear, but also essential and elegant, ARTURO is realised with top materials that harmonize with the space where it will be placed. ARTURO, available as armchair, two or three seater sofa, reveals the secret of a style that focuses on accuracy thanks to the wise use of the highest quality materials, high levels of finishing and attention to details.

Ample et linéaire, mais aussi simple et élégant, ARTURO se compose de matériaux de qualité qui s'harmonisent avec l'environnement où il sera placé. Disponible dans la version chauffeuse, canapé deux ou trois places, ARTURO nous révèle le secret d'un style basé sur la précision et traduit par la sage utilisation de matériaux de haute qualité, le haut niveau de finitions et l'attention au détail.

Groß und linear aber auch wesentlich und elegant. Dieser Stuhl besteht aus wertvolle Materialien, die den Raum harmonisieren. Arturo, als Sessel vorgeschlagen oder als 2- und 3-Sitzer Sofa, enthüllt das Geheimnis eines Stils welches auf Details konzentriert ist. Das Ergebnis ist nicht nur die geschickte Anwendung der wertvollen Materialien, sondern auch die hochwertige Feinbearbeitungen und die Liebe zum Detail.



Arturo

Arturo



Divano imbottito, struttura in legno, base in metallo. 1/2/3 posti.

Sofa, upholstered, wooden structure, metal base. 1/2/3 seats.

Canapé rembourré, structure en bois, piètement en métal. 1/2/3 places.

Sofa, gepolstert, Holzstruktur, Metallgestell. 1/2/3 Sitz.

versions

Arturo
1 seat

Arturo
2 seats

Arturo
3 seats



Arturo



Arturo



Arturo



Arturo

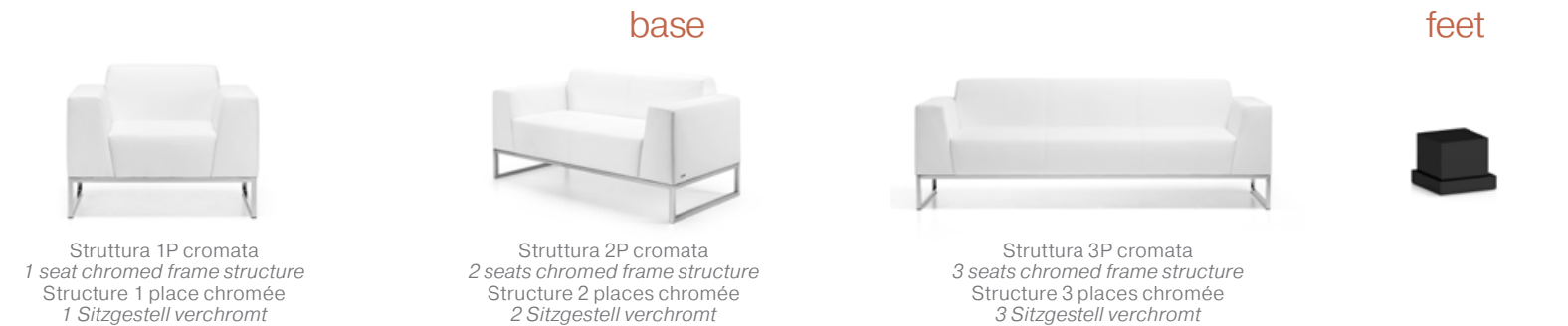
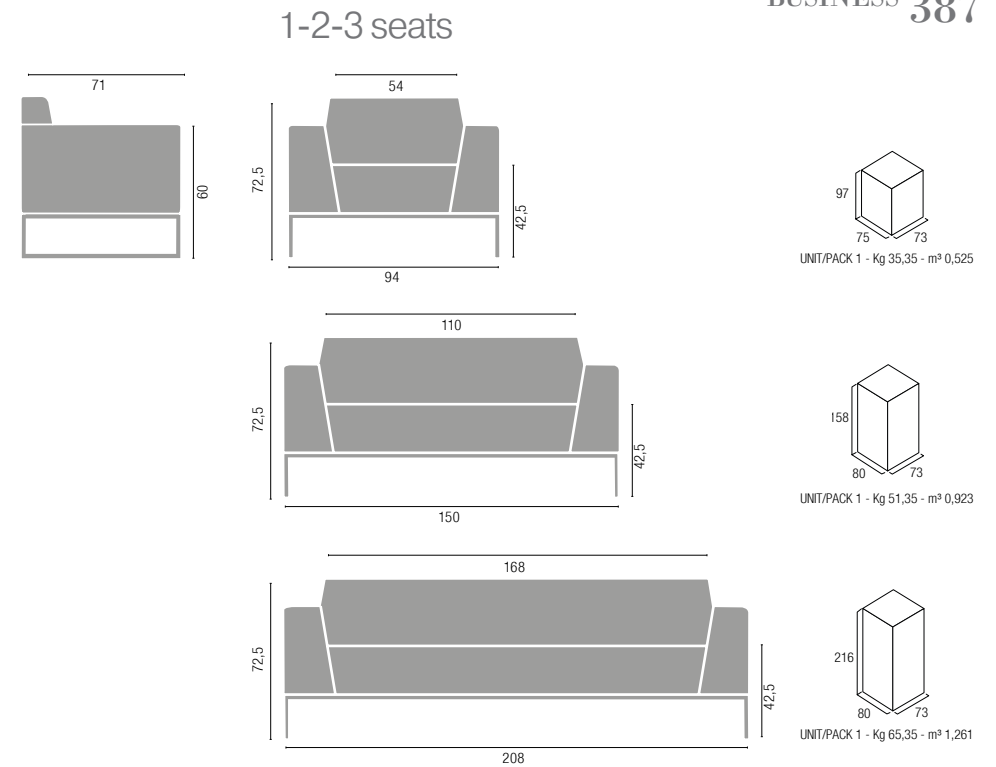
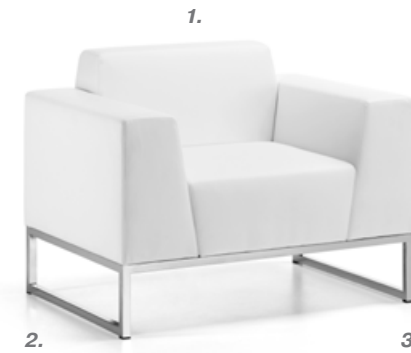

1. SCHIENALE:
Struttura 1/2/3 posti in multistrato di legno imbottito con spugna e rivestita in tessuto.

2. BASE:
Struttura in tubo quadro d'acciaio, 25x25mm, finitura cromata (15µm)

3. PIEDINI:
Tappi in polipropilene, finitura nera

1. BACKREST:
1/2/3 seats plywood structure, foam padding, fabric upholstery

2. BASE:
Square steel tube, 25x25mm, chromed finish (15µm)

3. FEET:
Polypropylene plugs, black finish

1. DOSSIER:
Structure 1/2/3 places en multiplie de bois rembourré de mousse et tapissée

2. PIETEMENT:
Structure en tube d'acier carré, 25x25mm, finition chromé (15µm)

3. PATINS:
Tampons en polypropylène, finition noir

1. RÜCKENLEHNE:
1/2/3 Sitz Holzstruktur ausgepolstert mit Schwamm und Stoffbezug

2. GESTELL:
Quadrat Stahlstruktur, 25x25 mm, verchromt (15 µm)

3. GLEITER:
Polyamid Gleiter, schwarz



BUS
INE
SS collection

Modulo

design: Pierluigi Galassi

MODULO di Moving è la libertà di inventare l'arredamento che preferisci ogni volta che vuoi. In ufficio come a casa, una serie di moduli componibili per creare oasi di riposo e angoli di relax nelle forme e nei colori che meglio rispondono ad ogni esigenza di interior design. Da MODULO nascono divani, poltrone e tavolini, tutti componibili tra loro per poter scegliere in ogni momento la funzionalità preferita per ogni spazio o momento da vivere. Ad ogni elemento della serie MODULO, declinabile nelle versioni ad uno, due o tre posti, sono applicabili a scelta sui vari lati braccioli e schienale per trasformare il divano in chaise longue, la poltrona in pouff, la dormeuse in tavolino.

MODULO by MOVING is the freedom to invent the furniture you want whenever you want. In the office or at home, a series of modular units to create an oasis of rest and relaxation in the forms and colours that best meet your requirements of interior design. From MODULO you create sofas, armchairs and tables, all modular so you can choose among them at any times your favorite feature for any space or moment to live. For each element of the series MODULO, available in one, two or three places, you can apply on the various sides, armrests and backrests in order to turn the sofa into a chaise longue, the armchair into an ottoman, the dormeuse into a small table.

MODULO de MOVING, est synonyme de liberté de créer l'ameublement que vous souhaitez, quand vous voulez. Soit dans le bureau soit à la maison, une série d'unités modulaires pour concevoir une oasis de repos et de détente dans les formes et les couleurs qui répondent au mieux à toute exigence du design d'intérieur. Canapés, fauteuils et petites tables, toutes modulables entre eux pour choisir à tout moment la fonction préférée pour tout espace ou moment à vivre. Pour chaque élément de la série MODULO, disponible dans les versions à 1, 2 ou 3 places, on peut appliquer aux choix sur les côtés, des accoudoirs ou des dossiers pour transformer le canapé en chaise longue, le fauteuil en pouf, la dormeuse en petite table.

MODULO von Moving ist die Freiheit Ihrer Lieblings-Einrichtung zu erfinden wann Sie es wünschen. Im Büro wie zuhause können Sie mit einer Serie von Modular Elemente eine Oase der Erholung und Entspannung einrichten, durch Formen und Farben, die Ihnen am besten passen, erfüllen die Bedürfnisse des Innendesign. Aus MODULO entstehen Kombinationen mit Sessel, Sofas und Tisch damit Sie jeder Zeit die Möglichkeit haben, funktionstüchtig Ihren Lebensraum in jedem Moment des Tages einzurichten. Für jedes Element von der Serie MODULO, Sessel, 2- oder 3-Sitzer sind Armlehnen und Rücklehnen je nach Bedarf, beidseitig verwend- oder einsetzbar, um folgende Verwandlungen zu haben: den Sofa in chaise longue, der Sessel in pouf, die "dormeuse" in einen kleinen Tisch.



Modulo

Modulo



Divano imbottito, struttura in legno, base in metallo. 1/2/3 posti.

Sofa, upholstered, wooden structure, metal base. 1/2/3 seats.

Canapé rembourré, structure en bois, piètement en métal. 1/2/3 places.

Sofa, gepolstert, Holzstruktur, Metallgestell. 1/2/3 Sitz.

versions

Modulo
1 seat

Modulo
2 seats

Modulo
3 seats



Modulo



Modulo





Modulo



1-2-3 seats

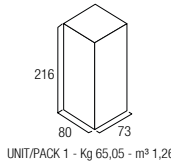
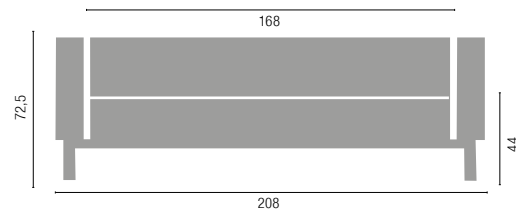
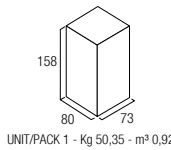
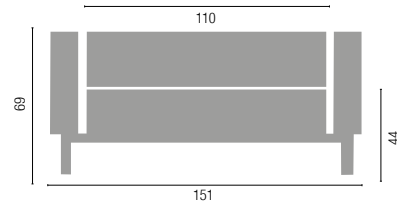
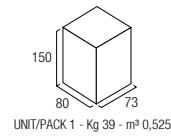
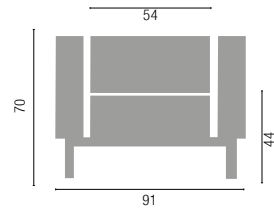
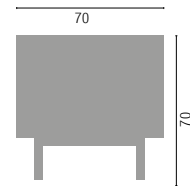

Elementi-pouff agganciabili / terminali
Ending / linking elements
Éléments-pouf accrochables / finaux
Pouf-Element / Verbindungssysteme

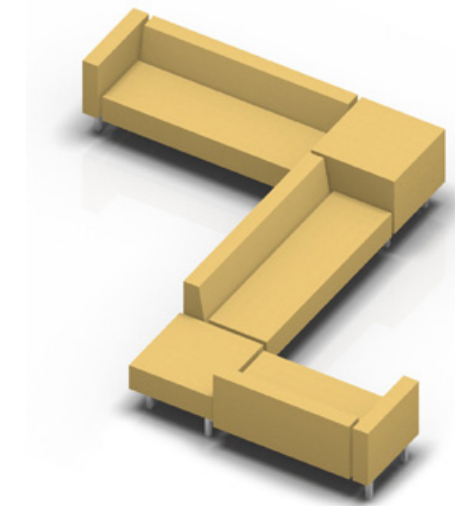
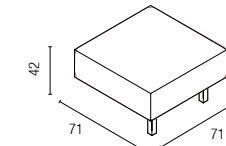
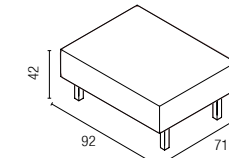
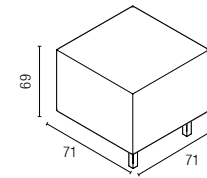

example

Elementi per componibilità / Modular elements
Éléments de modularité / Modular Elemente

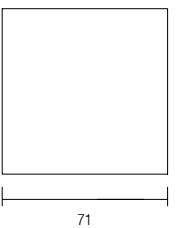
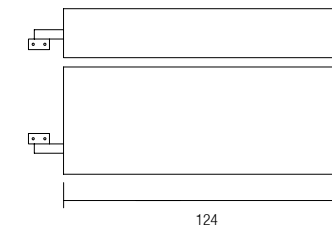
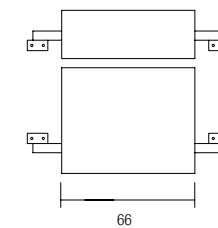

base

feet



Struttura 1P cromata
1 seat chromed frame structure
Structure 1 place chromée
1 Sitzgestell verchromt



Struttura 2P cromata
2 seats chromed frame structure
Structure 2 places chromée
2 Sitzgestell verchromt



Struttura 3P cromata
3 seats chromed frame structure
Structure 3 places chromée
3 Sitzgestell verchromt



1. SCHIENALE:
Struttura 1/2/3 posti (e accessori) in multistrato di legno imbottito con spugna e rivestita in tessuto.
2. BASE:
Struttura in tubo quadro d'acciaio, 40x40mm, finitura cromata (15µm)
3. PIEDINI:
Tappi in polipropilene, finitura nera

1. BACKREST:
1/2/3 seats (and accessory) plywood structure, foam padding, fabric upholstery
2. BASE:
Square steel tube, 40x40mm, chromed finish (15µm)
3. FEET:
Polypropylene plugs, black finish

1. DOSSIER:
Structure 1/2/3 places (et accessoires) en multiple de bois rembourré de mousse et tapissée
2. PIETEMENT:
Structure en tube d'acier carré, 40x40mm, finition chromé (15µm)
3. PATINS:
Tampons en polypropylène, finition noir

1. RÜCKENLEHNE:
1/2/3 Sitz Holzstruktur (und Zubehör) ausgepolstert mit Schwamm und Stoffbezug
2. GESTELL:
Quadrat Stahlstruktur, 40x40 mm, verchromt (15 µm)
3. GLEITER:
Polyamid Gleiter, schwarz

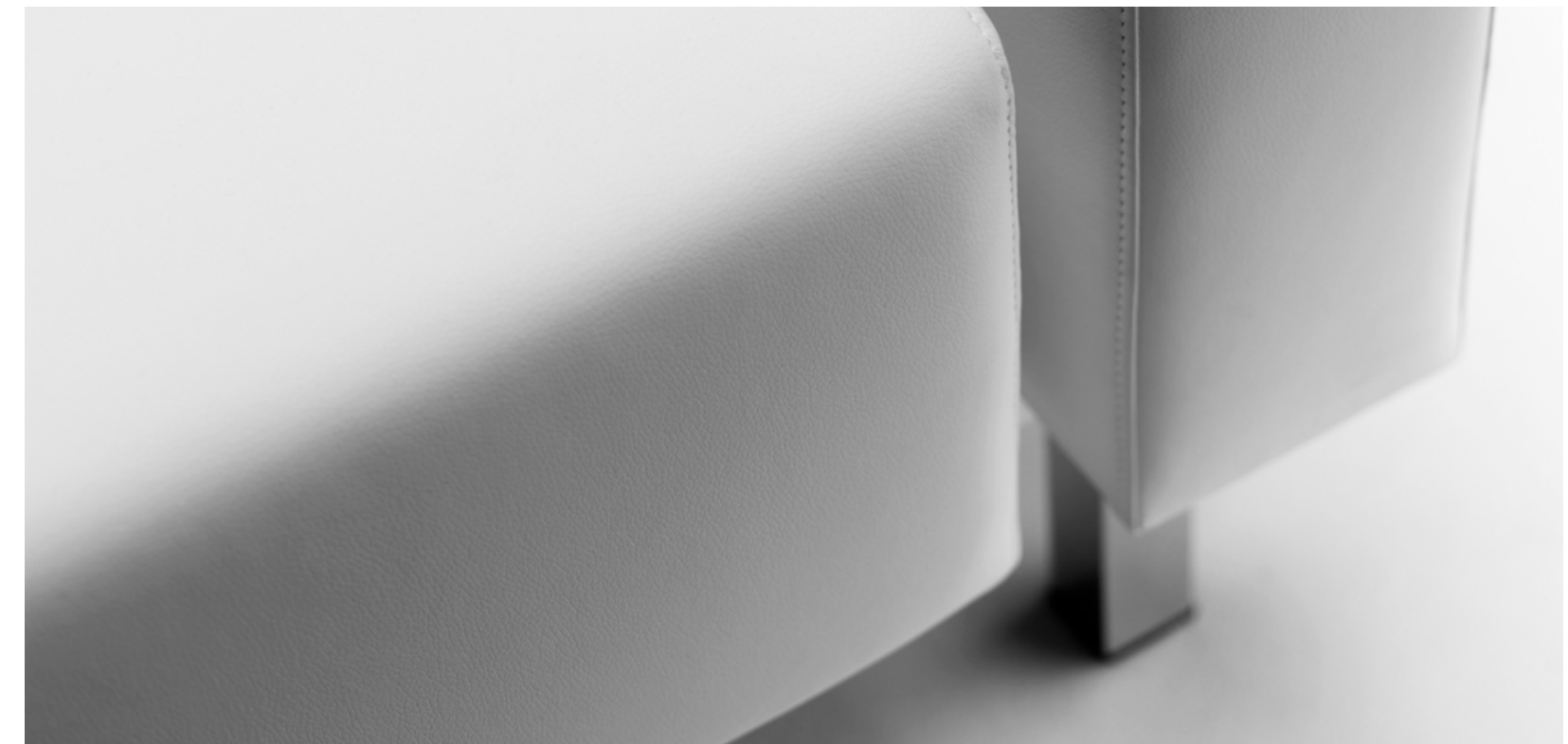

BUS
INE
SS collection

Giunone

design: AZ Creations

GIUNONE è un'elegante linea di divani che si presta a sale attese, conferenze e uffici di alto livello. Giunone ha un temperamento determinato e deciso, trasmette solidità e importanza, ma anche comodità e stile. È disponibile da uno a tre posti. La scocca è realizzata in legno.

GIUNONE is an elegant line of sofas that is especially suitable for waiting rooms, conference rooms and executive offices. Giunone has a determined and strong temperament, it conveys strength and importance, but also comfort and style. It is available from one to three seats. The frame is made of wood.

GIUNONE est une ligne élégante de canapés qui bien s'adapte aux salles d'attente, salles de conférence et bureaux directionnels. Giunone a un tempérament déterminé qui transmet de la force et de l'importance, mais aussi du confort et du style en même temps. Il est disponible de un à trois places. La coque est réalisée en bois.

GIUNONE ist eine elegante Linie von Sofas, geeignet für Wartezimmer, Konferenzräume und Chefbüros im hochwertigen Bereich. Giunone vermittelt entschlossenes und entscheidendes Temperament, Solidität und Wichtigkeit. Zu Verfügung von eins bis drei Sitze. Das Gestell ist aus Holz.



Giunone

Giunone



Divano imbottito, struttura in legno.
1/2/3 posti.

Sofa, upholstered, wooden structure.
1/2/3 seats.

Canapé rembourré, structure en bois.
1/2/3 places.

Sofa, gepolstert, Holzstruktur.
1/2/3 Sitz.

versions

Giunone
1 seat

Giunone
2 seats

Giunone
3 seats

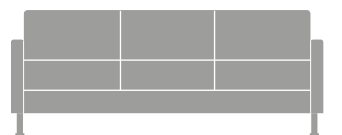

Giunone



Giunone



Giunone



Giunone

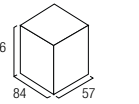
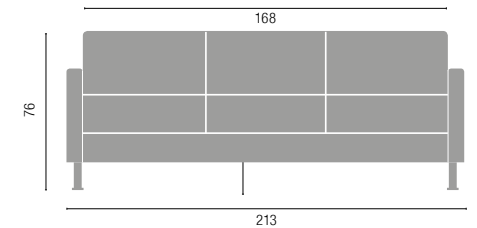
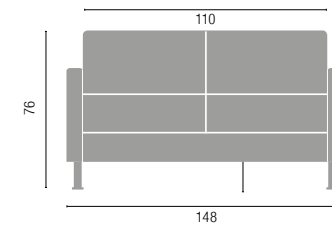
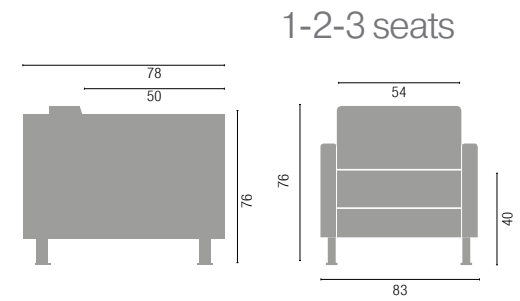

UNIT/PACK 1 - Kg 29,9 - m³ 0,412

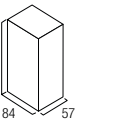

UNIT/PACK 1 - Kg 40,2 - m³ 0,733

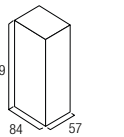

UNIT/PACK 1 - Kg 53,8 - m³ 1,049

feet



Piedino in alluminio o polimero termoplastico, finitura cromata
 Aluminium or thermoplastic polymer glides, chromed finish
 Patin en Aluminium ou polymère thermoplastique, finition chromée
 Aluminium oder thermoplastik Polymer Gleiter verchromt

1. SCHIENALE:
 Struttura 1/2/3 posti in multistrato di legno imbottito con spugna e rivestita in tessuto.
2. PIEDINI:
 Piedino in alluminio o polimero termoplastico, finitura cromata

1. BACKREST:
 1/2/3 seats plywood structure, foam padding, fabric upholstery
2. FEET:
 Aluminium or thermoplastic polymer glides, chromed finish

1. DOSSIER:
 Structure 1/2/3 places en multiplie de bois rembourré de mousse et tapissée
2. PATINS:
 Patin en aluminium ou polymère thermoplastique, finition chromée

1. RÜCKENLEHNE:
 1/2/3 Sitz Holzstruktur ausgepolstert mit Schwamm und Stoffbezug
2. GLEITER:
 Aluminium oder Thermoplastik Polymer Gleiter verchromt



Elettra

design: AZ Creations

ELETTRA è un'innovativa seduta unica nel suo genere, dall'inconfondibile design che mescola elementi geometrici a linee morbide per creare un'immagine elegante e originale. Elettra arreda con stile, è personalizzabile nel rivestimento, per essere frizzante o minimal, a seconda dell'ambiente in cui viene collocata.

ELETTRA is an innovative and unique seating, with an unmistakable design that combines geometric elements with soft lines in order to create an elegant and original figure. Elettra furnishes with style and can be customized in the upholstery, in order to result lively or minimal depending on the environment in which it is placed.

ELETTRA est un siège novateur, unique dans son genre, avec un design incomparable qui combine des éléments géométriques avec des lignes douces pour créer une image élégante et originale. Elettra fournit avec du style et peut se personnaliser soit dans le revêtement que dans la couleur du laquage, pour être vif ou minimaliste en fonction de l'environnement dans lequel il est placé.

ELETTRA ist eine innovative und einzigartige Sitzbank mit ein unverkennbares Design. Kombiniert aus geometrische Elemente und weiche Linien entsteht eine elegante und besondere Form. Elettra kann mit der Polsterung kundenspezifisch angepasst werden und ausstattet jeden Raum mit minimalistischen Stil.



Elettra

Elettra

Schienale e sedile imbottiti, piano in mdf laccato sp. 28mm. Struttura in acciaio. 2 posti.

Upholstered seat and backseat, 28mm lacquered mdf top, steel structure. 2 seats

Assise et dossier tapissés, plateau en MDF laqué, ép. 28mm, piètement en acier. 2 places.

Sitz und Rückenfläche gepolstert, 28 mm lackierte MDF Platte. 2 Sitz.



versions

Elettra



Elettra



Elettra

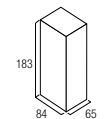
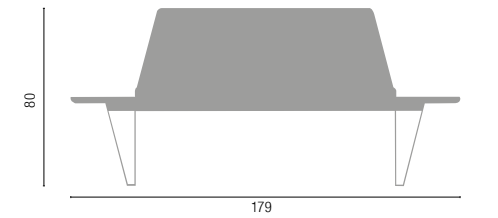

UNIT/PACK 1 - Kg 46 - m³ 1,04

base

feet



Struttura 2P cromata
2 seats chromed frame structure
Structure 2 places chromée
2 Sitzgestell verchromt

1. SCHIENALE:

Schienale in multistrato di legno, imbottito con spugna, rivestito in tessuto e sedile in MDF, finitura laccata, parzialmente imbottito e rivestito in tessuto

2. PIEDINI:

Struttura in trafilato d'acciaio, 35x5mm, finitura cromata (15µm)

1. BACKREST:

Plywood backrest, foam padded and fabric upholstery. MDF seat, laquered, partially padded and fabric upholstered

2. FEET:

Steel plate structure, 35x5mm, chromed finish (15µm)

1. DOSSIER:

Plateau en MDF, épaisseur 28mm, finition laqué, assise et dossier en multiplie de bois rembourré et tapissé

2. PATINS:

Structure en acier étiré, 35x35mm, finition chromé (15µm)

1. RÜCKENLEHNE:

Holzrückenlehne, ausgepolstert mit Kaltgeschäumten Polyurethan, mit Stoffbezug, lackierte Holz Sitzplatte, ausgepolstert mit kaltgeschäumten Polyurethan, mit Stoffbezug

2. GLEITER:

Stahlstruktur, 35x5 mm, verchromt (15µm)



BUS
INE
SS collection

Cardinale

design: AZ Creations

CARDINALE è una collezione di sedute che si distingue per il suo profilo soft nonostante l'immagine di imponenza che trasmette. È adatta a chi vuole godersi momenti di relax in un'avvolgente e comoda seduta dalle linee morbide e sinuose, per rilassare corpo e mente, ancora di più se accompagnata dal nuovo elegante pouf, ZAZA; è disponibile con schienale alto e basso, e riesce a rendere l'ambiente caldo e confortevole.

CARDINALE is a family of seating that stands out for its soft profile, despite the image of majesty it transmit.

It is suitable for those willing to enjoy some easy time on a seating with a sinuous and soft design, relaxing both the body and the mind, even more if accompanied by the new elegant ottoman ZAZA; it is available either with a high or with a low backrest, and contributes to making the environment warmer and more comfortable.

CARDINALE est une collection de fauteuils qui se distingue des autres sièges de la collection Top Collection pour le profil plus agréable, en dépit de l'image de grandeur qu'elle transmet. Cardinale est idéal pour ceux qui veulent profiter de moments de détente dans un fauteuil enveloppant et confortable avec des lignes douces et sinueuses, pour détendre le corps et l'esprit, d'autant plus si il est accompagné par le nouveau, élégant pouf ZAZA; il est disponible avec dossier haut ou bas, et il est en mesure de rendre l'environnement chaleureux et confortable.

CARDINALE ist eine Sessel-Kollektion die sich für sein weiches Profil gekennzeichnet, trotz ihrer stattliches beeindruckendes Aussehen. Dank seinem kuscheligen Sitzkomfort ist dieser Sessel geeignet für relaxende Momente zu Genie en. Cardinale, dank sein weiches und gewundenes Design, ermöglicht Körper und Seele zu Entspannen. Noch besser wenn man den Sessel mit der neue Fußstütze ZAZA' ausstattet. Verfügbar mit hohe oder niedrige Rückenlehne gibt Cardinale den Raum einen warmen und gemütlichen Eindruck.



Cardinale

Cardinale

Girevole, scocca in poliuretano, struttura in metallo. Schienale medio o alto.

Swivel, polyuretane shell, metal structure. Medium or high backrest.

Pivotant, coque en polyuréthane, structure en métal. Moyen ou haut dossier.

Drehbar, Polyurethanschale, Metallgestell. Mittlere oder Hohe Rückenlehne.



versions

Cardinale
High

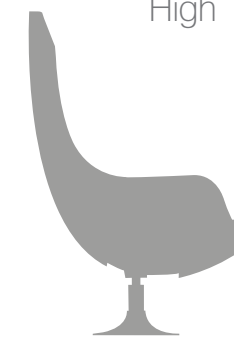

Cardinale
Medium

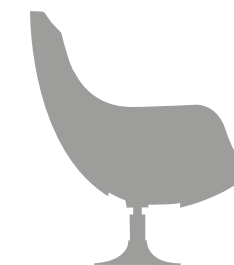

Zazà
Footrest



Cardinale

Medium



Cardinale



Cardinale

High



Cardinale Zazà



technical data

mechanism

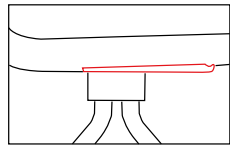

Piastra senza paletta
Flat metal plate
Platine sans palette
Sitzplatte ohne Hebel

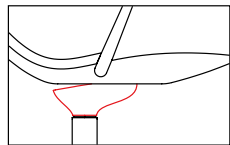

Molla oscillante
Tilting spring
Ressort basculant
Feder Wippmechanik

base



Base 4 razze in alluminio lucida
4-spoke polished aluminium base
Piè. 4 branches alu poli
4-Stern Alu poliertes Fußkreuz



Base 4 razze in ferro cromata
4-spoke chromed iron base
Piè. 4 branches en métal chromé
4-Stern verchromtes Eisen Fußkreuz

feet



options



headrest
XT010



Base a disco cromata grande
Chromed swivel round base
Piè. pivot. chromé sur disque grande
Drehbarer Tellerfuß verchromt



Base a disco cromata piccola
Chromed swivel round base
Piè. pivot. chromé sur disque petit
Drehbarer Tellerfuß verchromt

backrest High

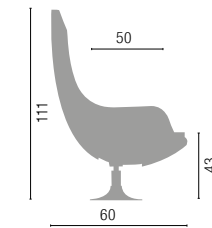

UNIT/PACK 1 - Kg 24,85 - m³ 0,663

backrest Medium

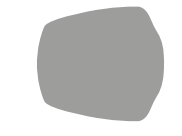
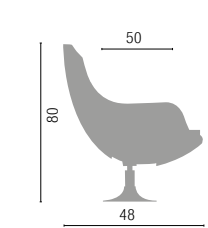

UNIT/PACK 1 - Kg 21,45 - m³ 0,5017

footrest Zazà

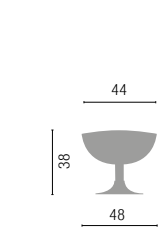

UNIT/PACK 1 - Kg 16,686 - m³ 0,15834



1. SCHIENALE:

Monoscocca in spugna schiumata a freddo con struttura portante in tubo tondo d'acciaio, Ø16mm, rivestita in tessuto

2. MECCANISMO:

Molla oscillante in alluminio cromato

3. GAS:

Altezza fissa, rotazione, finitura cromata

4. BASE:

- Base 4 razze in alluminio, Ø730mm, finitura lucida
- Base 4 razze in ferro, Ø720mm, finitura cromata (15µm)
- Base a disco in lastra d'acciaio, Ø600mm, finitura cromata (15µm)
- Base a disco in lastra d'acciaio, Ø480mm, finitura cromata (15µm)

5. PIEDINI:

- Piedini in polimero termoplastico, h. 25mm, finitura cromata (15µm)
- Piedini in polimero termoplastico, h. 40mm, finitura cromata (15µm)

1. BACKREST:

Cold injected foam padding monocoque, Ø16mm steel tube structure, fabric upholstery

2. MECHANISM:

Aluminium chromed tilting spring

3. GAS LIFT:

Not height adjustable, chromed finish

4. BASE:

- Polished aluminium 4 spoke base, Ø730 mm
- Iron 4 spoke base, Ø720 mm chromed finish (15µm)
- Round base, Ø600mm steel plate chromed finish (15µm)
- Round base, Ø480mm steel plate, chromed finish (15µm)

5. FEET:

- h.25mm Thermoplastic polymer gliders chromed finish (15µm)
- h.40mm Thermoplastic polymer gliders, chromed finish (15µm)

1. DOSSIER:

Monocoque en mousse moulée à froids avec châssis en tube d'acier rond, Ø16mm, tapissée

3. MECANISME:

Ressort basculant en aluminium poli

4. VERIN A GAZ:

Hauteur fixe, pivotant, finition chromé

5. PIÈTEMENT:

- Piètement 4 branches alu poli, Ø730mm
- Piètement 4 branches en métal, Ø720mm, finition chromé (15µm)
- Piètement disque en acier Ø600mm, finition chromé (15µm)
- Piètement disque en acier Ø480mm, finition chromé (15µm)

6. PATINS:

- Patins polymère thermoplastique, h.25mm, finition chromée (15µm)
- Patins polymère thermoplastique, h.40mm, finition chromée (15µm)

1. RÜCKENLEHNE:

Kaltgeschäumten Polyurethan Schale, mit Stoffbezug, Ø16 mm Stahlrohrschale

3. MECHANIK:

Aluminium polierte Feder Wippmechanik

4. GASFEDER:

Ohne Sitzhöhenverstellung, drehbar, verchromt

5. GESTELL:

- 4-Stern Alu poliertes Fußkreuz, Ø730 mm
- 4-Stern Eisen Fußkreuz, Ø720mm verchromt (15µm)
- Stahlplatte Tellerfuß, Ø600mm, verchromt (15µm)
- Stahlplatte Tellerfuß, Ø480mm, verchromt (15µm)

6. GLEITER:

- Thermoplastische Polymergleiter, H.25mm, verchromt (15µm)
- Thermoplastische Polymergleiter, H.40mm, verchromt (15µm)



BUS
INE
SS collection

Carmen

design: AZ Creations

CARMEN è una seduta morbida ed avvolgente, ha un profilo elegante caratterizzato da linee pulite e decise. Carmen è personalizzabile nel rivestimento e nella base, elementi che la rendono capace di arredare con stile diverse tipologie di ambiente, portando un tocco di fantasia e classe.

CARMEN is a soft and embracing seating, with elegant profile and clean lines. Carmen can be customized in the upholstery and in the base, elements that allow it to furnish with style different kind of spaces, bringing a touch of fantasy and class.

CARMEN est une chauffeuse souple et enveloppante, caractérisée par un profil élégant et des lignes épurées. Carmen est personnalisable dans le revêtement et dans le piètement, ce qui lui permet de meubler avec style des lieux différents, en apportant une touche de fantaisie et de classe.

CARMEN Ein weichen einhüllenden Sessel, der durch seine saubere und klare Linien gekennzeichnet ist. Carmen kann durch Polsterungen und den Fußkreuze je nach Wunsch ausgestattet werden. Diese Bauelemente erlauben mit Phantasie und Stil verschiedene Bereiche einzurichten.



Carmen

Carmen

Scocca in poliuretano, struttura in metallo. Fissa o girevole.

Polyurethane foam shell, metal structure. Fixed or swivel.

Coque en polyuréthane, structure en métal. Fixe ou pivotant.

Polyurethanschale, Metallgestell. Drehbar oder Besucher.



versions

Carmen
Swivel

Carmen
4-spoke

Carmen
Round

Carmen
4-legs

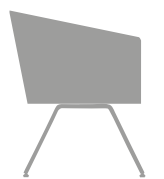

Carmen





Carmen



swivel

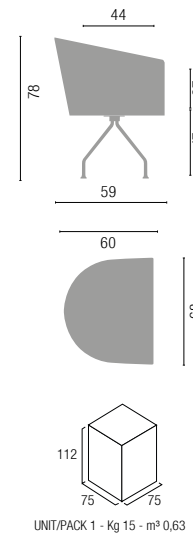

4-spoke alu.

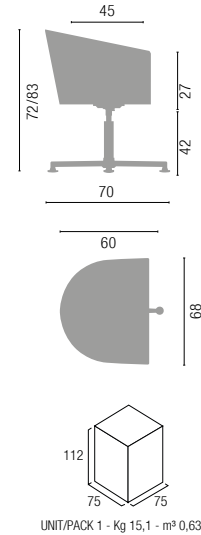

4-spoke iron

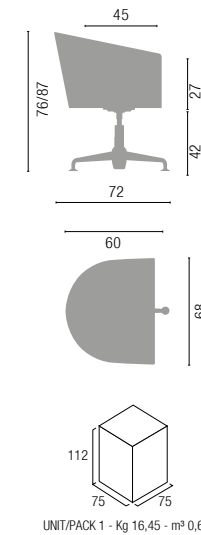

round

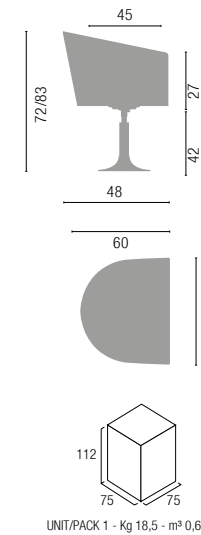

4-legs

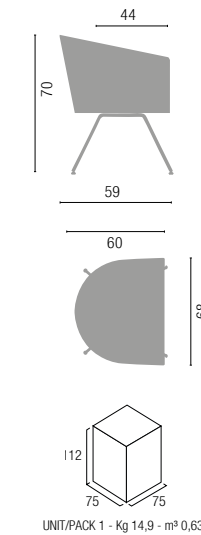

technical data

mechanism

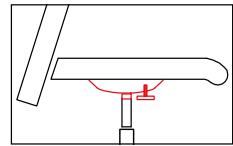

Piastra
Seat plate
Platine
Sitzplatte

base



Base ragno cromata
Chromed swivel base
Pièt. 4 piedi pivot. chromé
4-Fuß Drehkreuz verchromt



Base a disco cromata piccola
Chromed swivel round base
Pièt. pivot. chromé sur disque petit
Drehbarer Tellerfuß verchromt



Base 4 gambe cromata
4-legs chromed base
Pièt. 4 pieds chromé
4-Fuß Gestell verchromt



Base a 4 razze in alluminio lucida
Polished aluminium 4 spoke base
Piètement 4 branches alu poli
Alu poliertes 4-Stern Fußkreuz



Base 4 razze in ferro cromata
4-spoke chromed iron base
Pièt. 4 branches en métal chromé
4-Stern verchromtes Eisen Fußkreuz

feet



1. SCHIENALE:

Struttura in multistrato di legno imbottito con spugna e rivestita in tessuto

2. MECCANISMO:

Comando elevazione a gas, finitura nera

3. GAS:

- Regolabile in altezza, rotazione, finitura cromata
- Altezza fissa, ritorno automatico, finitura cromata

4. BASE:

- Base 4 razze in alluminio, Ø 630mm, finitura lucida
- Base 4 razze in ferro, Ø 720mm, finitura cromata (15µm)
- Base a disco in lastra d'acciaio, Ø480mm, finitura cromata (15µm)
- Base 4 gambe a ragno in tubo d'acciaio Ø 20mm, finitura cromata (15µm)
- Base 4 gambe in tubo d'acciaio Ø 16mm, finitura cromata (15µm)

5. PIEDINI:

- Tappi in polipropilene, finitura nera o bianca
- Piedini snodati in poliamide, finitura cromata (15µm), nera o bianca
- Piedini in polimero termoplastico, h. 25mm, finitura cromata (15µm)
- Piedini in polimero termoplastico, h. 40mm, finitura cromata (15µm)
- feltrini

1. BACKREST:

Plywood structure, foam padding, fabric upholstery

2. MECHANISM:

Height adjustable, Black finish

3. GAS LIFT:

- Height adjustable, swivel, chromed finish
- Not height adjustable, memory return cylinder, chromed finish

4. BASE:

- Iron 4 spoke base, Ø 720 mm chromed finish (15µm)
- Round base, Ø480mm steel plate, chromed finish (15µm)
- 4 legs swivel base, Ø 22 mm steel tube, chromed finish (15µm)
- Polished aluminium 4 spoke base, Ø630 mm
- 4 legs base, Ø16mm steel tube, chromed finish (15µm)

5. FEET:

- Polypropylene plugs, black or white finish
- Leveler glides in polyamide, chromed finishes (15µm), black or white
- h.25mm Thermoplastic polymer gliders chromed finish (15µm)
- h.40mm Thermoplastic polymer gliders, chromed finish (15µm)
- felts

1. DOSSIER: Structure en multiple de bois rembourré de mousse et tapissée

3. MECANISME:

Réglable en hauteur, finition noir

4. VERIN A GAZ:

Réglable en hauteur, pivotant, finition chromé
Hauteur fixe, retour automatique, finition chromé

5. PIÈTEMENT:

- Piètement 4 branches alu poli, Ø 630mm
- Piètement 4 branches en métal, Ø 720mm, finition chromé (15µm)
- Piètement disque en acier Ø 480mm, finition chromé (15µm)
- Piètement araigné 4 pieds en tube d'acier Ø 20mm, finition chromé (15µm)
- Piètement 4 pieds en tube d'acier Ø 16mm, finition chromé (15µm)

6. PATINS:

- Tampons en polypropylène, finition noir ou blanc
- Patins articulés et polyamide, finition chromée (15µm), noir ou blanc
- Patins polymère thermoplastique, h.25mm, finition chromée (15µm)
- Patins polymère thermoplastique, h.40mm, finition chromée (15µm)
- feutres

1. RÜCKENLEHNE:

Holzstruktur, ausgepolstert mit Schwamm und Stoffbezug

2. MECHANIK:

Schwarze Sitzhöhenverstellung

3. GASFEDER:

- Sitzhöhenverstellung, drehbar, verchromt
- Ruckholmechanik ohne Sitzhöhenverstellung, verchromt

4. GESTELL:

- 4-Stern Alu poliertes Fußkreuz, Ø 630 mm
- 4-Stern Eisen Fußkreuz, Ø720mm verchromt (15µm)
- Stahlplatte Tellerfuß, Ø480mm, verchromt (15µm)
- 4-Fuß Drehkreuz, Ø20 mm Stahlrohr, verchromt (15µm)
- 4-Fuß Gestell, Ø16mm Stahlrohr, verchromt (15µm)

5. GLEITER:

- Polyamid Gleiter, schwarz oder weiss
- Gelenkgleiter aus Polyamid, verchromt (15µm), schwarz oder weiss
- Thermoplastische Polymergleiter, H.25mm, verchromt (15µm)
- Thermoplastische Polymergleiter, H.40mm, verchromt (15µm)
- Filzgleiter



Tosca

design: AZ Creations

TOSCA è una seduta dalla forma avvolgente adatta a chi vuole godersi momenti di relax in una "poltrona" confortevole: Tosca può essere personalizzata con diversi rivestimenti, la sua forma moderna e innovativa ben si adatta a colori vivi e sgargianti, ma anche ad arredamenti dalle forme eleganti e di design.

TOSCA is a seating with an embracing shape, suitable for those who want to enjoy some relaxing time on a comfortable armchair: Tosca can be customised with several kind of upholstery and its modern and innovative design easily adapts to bright and lively colours, but also to elegant and design furniture.

TOSCA est une chauffeuse de forme enveloppante, idéale pour ceux qui veulent profiter d'un moment de détente sur un fauteuil confortable : Tosca peut être personnalisée avec plusieurs types de tissu, sa forme moderne et innovante s'adapte facilement aux couleurs vives et brillantes, mais aussi au mobilier élégant e de design.

TOSCA Ein Sessel mit einhüllende Form, geeignet um relaxende Momente zu genie en. Tosca kann mit verschiedenen Polsterungen ausgestattet werden; seine moderne und innovative Form passt hervorragend zu leuchtende und strahlende Farben, sowie auch zu Design-Möbeln und elegante Einrichtungen.



Tosca



Tosca

Scocca in poliuretano, struttura in metallo. Fissa o girevole.

Polyurethane foam shell, metal structure. Fixed or swivel.

Coque en polyuréthane, structure en métal. Fixe ou pivotant.

Polyurethanschale, Metallgestell. Drehbar oder Besucher.

versions

Tosca
4-spoke



Tosca
Round



Tosca
4-legs



Tosca

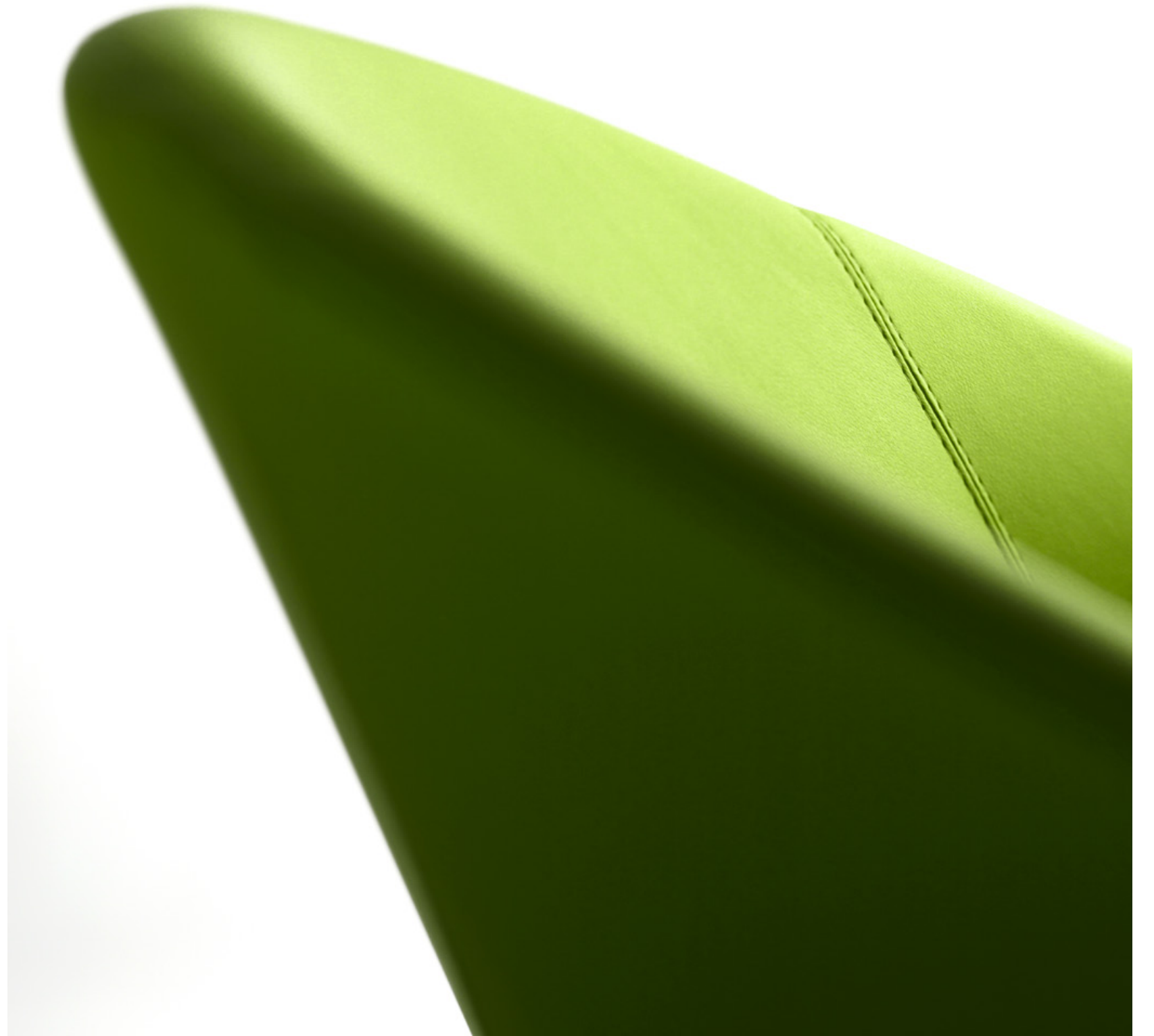



Tosca



4-spoke alu.

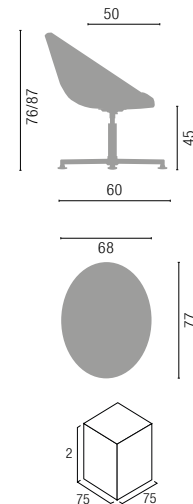

UNIT/PACK 1 - Kg 16,95 - m³ 0,63

4-spoke iron

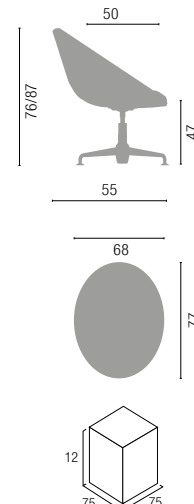

UNIT/PACK 1 - Kg 16,9 - m³ 0,63

round

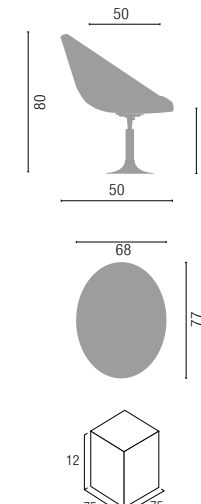

UNIT/PACK 1 - Kg 18,55 - m³ 0,63

4-legs

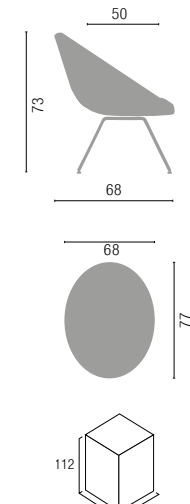

UNIT/PACK 1 - Kg 15,9 - m³ 0,63



technical data

mechanism

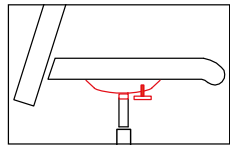

Piastra
Seat plate
Platine
Sitzplatte

base



Base a 4 razze in alluminio lucida
Polished aluminium 4 spoke base
Piètement 4 branches alu poli
Alu poliertes 4-Stern Fußkreuz



Base a disco cromata piccola
Chromed swivel round base
Pièt. pivot. chromé sur disque petit
Drehbarer Tellerfuß verchromt



Base 4 razze in ferro cromata
4-spoke chromed iron base
Pièt. 4 branches en métal chromé
4-Stern verchromtes Eisen Fußkreuz



Base 4 gambe cromata
4-legs chromed base
Pièt. 4 pieds chromé
4-Fuß Gestell verchromt

feet



1. SCHIENALE:

Monosocca in spugna schiumata a freddo con struttura portante in tubo tondo d'acciaio, Ø 16mm, rivestita in tessuto

2. MECCANISMO:

Comando elevazione a gas, finitura nera

3. GAS:

- Regolabile in altezza, rotazione, finitura cromata
- Altezza fissa, ritorno automatico, finitura cromata

4. BASE:

- Base 4 razze in alluminio, Ø 630mm, finitura lucida
- Base 4 razze in ferro, Ø 720mm, finitura cromata (15µm)
- Base a disco in lastra d'acciaio, Ø480mm, finitura cromata (15µm)
- Base 4 gambe in tubo d'acciaio Ø 16mm, finitura cromata (15µm)

5. PIEDINI:

- Piedini snodati in poliamide, finitura cromata (15µm), nera o bianca
- Piedini in polimero termoplastico, h. 25mm, finitura cromata (15µm)
- Piedini in polimero termoplastico, h. 40mm, finitura cromata (15µm)
- feltrini

1. BACKREST:

Cold injected foam padding monocoque, Ø 16mm steel tube structure, fabric upholstery

2. MECHANISM:

Height adjustable, Black finish

3. GAS LIFT:

- Height adjustable, swivel, chromed finish
- Not height adjustable, memory return cylinder, chromed finish

4. BASE:

- Iron 4 spoke base, Ø 720 mm chromed finish (15µm)
- Round base, Ø480mm steel plate, chromed finish (15µm)
- Polished aluminium 4 spoke base, Ø630 mm
- 4 legs base, Ø16mm steel tube, chromed finish (15µm)

5. FEET:

- Leveler glides in polyamide, chromed finishes (15µm), black or white
- h.25mm Thermoplastic polymer gliders chromed finish (15µm)
- h.40mm Thermoplastic polymer gliders, chromed finish (15µm)
- felts

1. DOSSIER:

Monocoque en mousse moulée à froids avec châssis en tube d'acier rond, Ø 16mm, tapissée

2. MECANISME:

Réglable en hauteur, finition noir

3. VERIN A GAZ:

- Réglable en hauteur, pivotant, finition chromé
- Hauteur fixe, retour automatique, finition chromé

4. PIÈTEMENT:

- Piètement 4 branches alu poli, Ø 630mm
- Piètement 4 branches en métal, Ø 720mm, finition chromé (15µm)
- Piètement disque en acier Ø 480mm, finition chromé (15µm)
- Piètement 4 pieds en tube d'acier Ø 16mm, finition chromé (15µm)

5. PATINS:

- Patins articulés et polyamide, finition chromée (15µm), noir ou blanc
- Patins polymère thermoplastique, h.25mm, finition chromée (15µm)
- Patins polymère thermoplastique, h.40mm, finition chromée (15µm)
- feutres

1. RÜCKENLEHNE:

Kaltgeschäumten Polyurethan, mit Stoffbezug, Ø 16mm Stahlrohrschale

2. MECHANIK:

Schwarze Sitzhöhenverstellung

3. GASFEDER:

- Sitzhöhenverstellung, drehbar, verchromt
- Ruckholmechanik ohne Sitzhöhenverstellung, verchromt

4. GESTELL:

- 4-Stern Alu poliertes Fußkreuz, Ø 630 mm
- 4-Stern Eisen Fußkreuz, Ø720mm verchromt (15µm)
- Stahlplatte Tellerfuß, Ø480mm, verchromt (15µm)
- 4-Fuß Gestell, Ø16mm Stahlrohr, verchromt (15µm)

5. GLEITER:

- Gelenkgleiter aus Polyamid, verchromt (15µm), schwarz oder weiss
- Thermoplastische Polymergleiter, h.25mm, verchromt (15µm)
- Thermoplastische Polymergleiter, h.40mm, verchromt (15µm)
- Filzgleiter



Bohème

design: AZ Creations

BOHÈME è una seduta che, come le altre del Business Center, può essere definita polivalente, per la particolarità di arredare perfettamente diverse tipologie di ambiente. Altisonante nel nome, Bohème si presenta con un'immagine armonica caratterizzata dalle linee sinuose della scocca, che ben si sposa con le diverse modalità di rivestimento del legno (multistrato di faggio); il tocco finale è dato dal morbido cuscino che può essere personalizzato con vari rivestimenti.

BOHÈME is a seating that, thanks to its capability to perfectly furnish different typologies of environment, can be defined as a multipurpose product, like the other Business Center models. Though with a high-sounding name, Bohème has balanced design characterised by the sinuous lines of the shell, that goes well together with the several finishes of the wood (multi-layer beech); the soft cushion, that can be customized in several finishes, is the final touch.

BOHÈME est un fauteuil qui, comme les autres modèles de la collection Business Center, peut être décrit comme polyvalent, grâce à sa caractéristique d'être capable de fournir parfaitement les différents types d'environnement. Bohème se présente avec une image harmonieuse caractérisée par les lignes sinueuses de la coque, qui va bien avec les différentes finitions du bois (hêtre stratifié) ; la touche finale est donnée par le coussin qui peut être personnalisé avec plusieurs revêtements.

BOHEME Ist ein Stuhl wie andere aus unserem Business Center Programm, welcher als mehrwertig bezeichnet werden kann für seine Besonderheit, die Einrichtung in verschiedene Bereiche perfekt auszustatten. BOHEME, der Namen selbst darstellt Hochwertigkeit, und seine Holzschale mit gewundene Linie präsentiert ein harmonisches Aussehen. Die Schale ist aus Mehrschicht Buchenholz und ist in verschiedene Lackfarben erhältlich. Ein weiches Kissen mit verschiedene Polsterungen zu wählen, gibt dem ganzen einen Schliff.



Boheme

Boheme

Scocca in legno, struttura in metallo cromata. Laccato o verniciato.
Fissa o girevole

Wooden shell, metal structure.
Laquered or matt. Fixed or swivel

Coque en bois, structure en métal.
Laqué ou vernie. Fixe ou pivotant

Holzschale, Metallgestell.
Lackiert oder gefärbt.



versions

Tosca
Swivel

Tosca
4-spoke

Tosca
Round

Tosca
4-legs



Boheme



Boheme





Boheme

Boheme

Boheme





Boheme



swivel

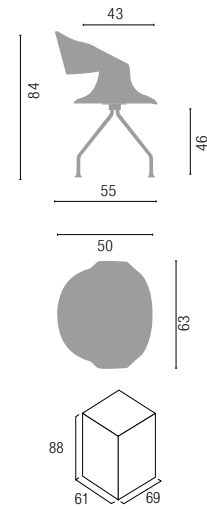

UNIT/PACK 1 - Kg 12,5 - m³ 0,37

4-spoke alu.

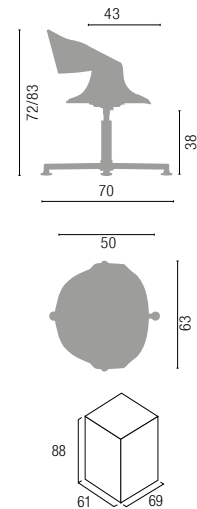

UNIT/PACK 1 - Kg 12,2 - m³ 0,37

4-spoke iron

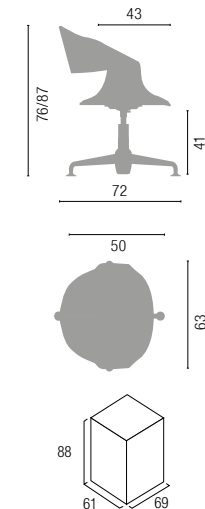

UNIT/PACK 1 - Kg 13,2 - m³ 0,37

round

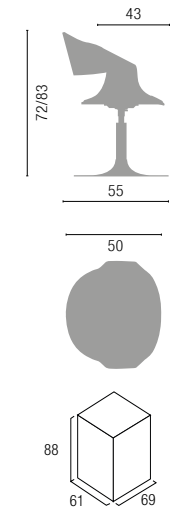

UNIT/PACK 1 - Kg 15,15 - m³ 0,37

4-legs

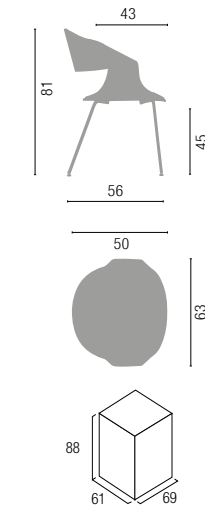

UNIT/PACK 1 - Kg 10,95 - m³ 0,37



technical data

mechanism

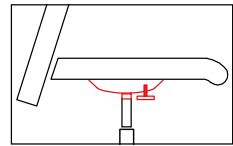

Piastra
Seat plate
Platine
Sitzplatte

base



Base ragno cromata
Chromed swivel base
Pièr. 4 pieds pivot. chromé
4-Fuß Drehkreuz verchromt



Base a disco cromata piccola
Chromed swivel round base
Pièr. pivot. chromé sur disque petit
Drehbarer Tellerfuß verchromt



Base 4 gambe cromata
4-legs chromed base
Pièr. 4 pieds chromé
4-Fuß Gestell verchromt



Base a 4 razze in alluminio lucida
Polished aluminium 4 spoke base
Pièr. 4 branches alu poli
Alu poliertes 4-Stern Fußkreuz



Base 4 razze in ferro cromata
4-spoke chromed iron base
Pièr. 4 branches en métal chromé
4-Stern verchromtes Eisen Fußkreuz

castors/feet



1. SCHIENALE:

Monosocca in multistrato di legno di faggio o rovere, finitura laccata o verniciata, con sedile in spugna rivestita in tessuto

2. MECCANISMO:

Comando elevazione a gas, finitura nera

3. GAS:

- Regolabile in altezza, rotazione, finitura cromata
- Altezza fissa, ritorno automatico, finitura cromata

4. BASE:

- Base 4 razze in alluminio, Ø 630mm, finitura lucida
- Base 4 razze in ferro, Ø 720mm, finitura cromata (15µm)
- Base a disco in lastra d'acciaio, Ø480mm, finitura cromata (15µm)
- Base 4 gambe a ragno in tubo d'acciaio Ø 20mm, finitura cromata (15µm)
- Base 4 gambe in tubo d'acciaio Ø 12mm, finitura cromata (15µm)

5. RUOTE/PIEDINI:

- Tappi in polipropilene, finitura nera o bianca
- Piedini snodati in poliamide, finitura cromata (15µm), nera o bianca
- Piedini in polimero termoplastico, h. 25mm, finitura cromata (15µm)
- Piedini in polimero termoplastico, h. 40mm, finitura cromata (15µm)
- feltrini
- Ruote Ø 50mm, autofrenanti o autofrenanti e gommate, finitura cromata

1. BACKREST:

Bleach or durmast plywood monocoque, lacquered, painted foam padded seat cushion, fabric upholstery

2. MECCANISMO:

Comando elevazione a gas, finitura nera

3. GAS LIFT:

- Height adjustable, swivel, chromed finish
- Not height adjustable, memory return cylinder, chromed finish

4. BASE:

- Iron 4 spoke base, Ø 720 mm chromed finish (15µm)
- Round base, Ø480mm steel plate, chromed finish (15µm)
- 4 legs swivel base, Ø 22 mm steel tube, chromed finish (15µm)
- Polished aluminium 4 spoke base, Ø630 mm
- 4 legs base, Ø12mm steel tube, chromed finish (15µm)

5. CASTORS/FEET:

- Polypropylene plugs, black or white finish
- Leveler glides in polyamide, chromed finishes (15µm), black or white
- h.25mm Thermoplastic polymer gliders chromed finish (15µm)
- h.40mm Thermoplastic polymer gliders, chromed finish (15µm)
- felts
- chromed soft self-braking castors d.50mm

1. DOSSIER:

Monocoque en multiplie de hêtre ou chaine, finition laqué ou vernie, assise en mousse et revêtue

2. MECANISME:

Réglable en hauteur, finition noir

3. GASFEEDER:

- Réglable en hauteur, pivotant, finition chromé
- Hauteur fixe, retour automatique, finition chromé

5. PIETEMENT:

- Pièr. 4 branches alu poli, Ø 630mm
- Pièr. 4 branches en métal, Ø 720mm, finitura cromata (15µm)
- Pièr. 4 branches en acier Ø 480mm, finitura cromata (15µm)
- Pièr. 4 branches en tube d'acier Ø 20mm, finitura cromata (15µm)
- Pièr. 4 branches en tube d'acier Ø 12mm, finitura cromata (15µm)

6. ROULETTES/PATINS:

- Tampons en polypropylène, finitura noir ou blanc
- Patins articulés et polyamide, finitura cromata (15µm), noir ou blanc
- Patins polymère thermoplastique, h.25mm, finitura cromata (15µm)
- Patins polymère thermoplastique, h.40mm, finitura cromata (15µm)
- feutres
- roulettes d.50mm chromées gommées autofrein.

1. RÜCKENLEHNE:

Buchen oder Eichen Holzschale, lackiert, gefärbt oder ausgepolstert mit Schwamm und Stoffbezug

2. MECHANIK:

Schwarze Sitzhöhenverstellung

3. GASFEDER:

- Sitzhöhenverstellung, drehbar, verchromt
- Ruckholmechanik ohne Sitzhöhenverstellung, verchromt

4. GESTELL:

- 4-Stern Alu poliertes Fußkreuz, Ø 630 mm
- 4-Stern Eisen Fußkreuz, Ø720mm verchromt (15µm)
- Stahlplatte Tellerfuß, Ø480mm, verchromt (15µm)
- 4-Fuß Drehkreuz, Ø20 mm Stahlrohr, verchromt (15µm)
- 4-Fuß Gestell, Ø12mm Stahlrohr, verchromt (15µm)

5. ROLLEN/GLEITER:

- Polyamid Gleiter, schwarz oder weiss
- Gelenkgleiter aus Polyamid, verchromt (15µm), schwarz oder weiss
- Thermoplastische Polymergleiter, H.25mm, verchromt (15µm)
- Thermoplastische Polymergleiter, H.40mm, verchromt (15µm)
- Filzgleiter
- verchromte weiche gebremste Rollen D. 50mm



BUS
INE
SS collection

Aida

design: AZ Creations

AIDA è una seduta dall'aspetto "easy" e vivace, capace di rendere l'arredamento vivo e allegro; la robustezza dell'interno in legno multistrato di faggio si contrappone all'espressività del rivestimento, sia esso laccato, verniciato sbiancato o wengè, o tappezzato. Aida è disponibile con diverse basi, ognuna adatta a valorizzare la seduta in tutti i suoi aspetti.

AIDA is an easy and lively chair, capable of cheering up the environment in which it is located; the robustness of the multi-layer oak wood shell contrasts with the brightness of the finishes, be it lacquered, veneered or upholstered. Aida is available with different bases, each one capable of increasing the value of every aspect of the chair.

AIDA est une chaise d'apparence "easy", capable de rendre vif et gai l'environnement; la robustesse de l'intérieur en bois (hêtre stratifié) s'oppose à l'expressivité de la finition, soit laquée, vernie chêne blanchi, wengé ou tapissée. Aida est disponible en différents piétements, chacun apte à valoriser la chaise en tous ses aspects.

AIDA Ein Stuhl mit ein lebendiges und einfaches Aussehen, fähig die Inneneinrichtung leuchtend und fröhlich zu machen; die Stärke vom Mehrschicht Buchenholz ist im Kontrast mit der Oberfläche, und kann lackiert, gebleicht oder „Wenge“ sein, oder ausgepolstert werden. Aida ist mit verschiedenen Fußkreuze zu haben um den Stuhl in allen seinen Aspekten aufwerten.



Aida

Aida

Scocca in legno, struttura in metallo.
Laccato o verniciato. Tappezzata liscia
o a fasce.

Wooden shell, metal structure.
Laquered or matt. Upholstered or with
stripes.

Coque en bois, structure en métal.
Laquée ou vernie. Tapissee simple ou
en bandes.

Holzschale, Metallgestell. Lackiert
oder gefärbt Gepolst. Mit oder ohne
Steppungen.



versions

Aida
Swivel

Aida
4-legs

Aida
Sled base





Aida



Aida





Aida

Aida





Aida



4-legs

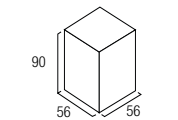
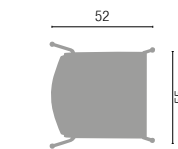
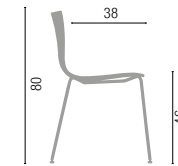

UNIT/PACK 1 - Kg 7,6 - m³ 0,282

sled base

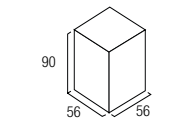
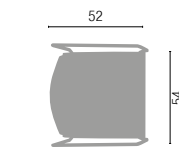
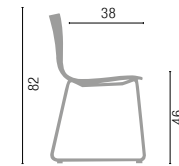

UNIT/PACK 1 - Kg 8,9 - m³ 0,282

swivel

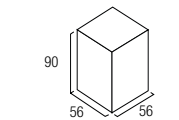
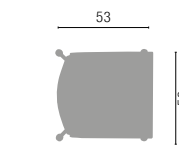
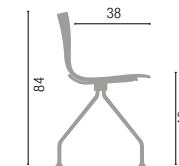

UNIT/PACK 1 - Kg 9,4 - m³ 0,284

swivel castors

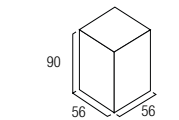
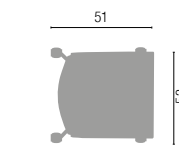
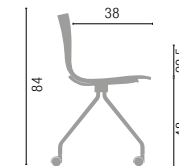

UNIT/PACK 1 - Kg 9,75 - m³ 0,282



technical data

mechanism

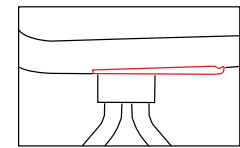

Piastra
Seat plate
Platine
Sitzplatte

base



Base 4 gambe cromata
4-legs chromed base
Piè. 4 pieds chromé
4-Fuß Gestell verchromt



Base a slitta cromata
Chromed sled base
Piè. luge chromé
Kufengestell verchromt



Base ragno cromata
Chromed swivel base
Piè. 4 pieds pivot. chromé
4-Fuß Drehkreuz verchromt

castors/feet



options

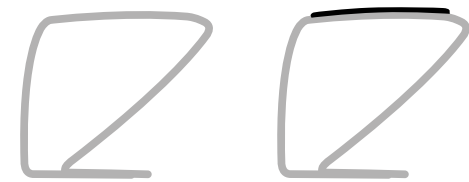

XB075 - chromed

XB076 - chromed
uph. pad

1. SCHIENALE:

Monoscocca in multistrato di legno di faggio o rovere, finitura laccata, verniciata o spugna rivestita

2. BASE:

- Base 4 gambe a ragno in tubo d'acciaio Ø 20mm, finitura cromata (15µm)
- Base 4 gambe in tubo d'acciaio Ø 12mm, finitura cromata (15µm)
- Base a slitta in tubo d'acciaio Ø 16mm, finitura cromata (15µm)

3. RUOTE/PIEDINI:

- Ruote Ø 50mm, autofrenanti o autofrenanti e gommate, finitura cromata (15µm), nera o bianca
- Piedini snodati in poliamide, finitura cromata (15µm), nera o bianca
- Piedini in polimero termoplastico, h. 68mm, finitura cromata (15µm)
- Tappi in polipropilene, finitura nera o bianca

1. BACKREST:

Bleach or durmast plywood monocoque, lacquered, painted or padded upholstery foam

2. BASE:

- Polished aluminium 4 spoke base, Ø630 mm
- 4 legs base, Ø12mm steel tube, chromed finish (15µm)
- Cantilever base, Ø 16 mm steel tube, chromed finish (15µm)

3. CASTORS/FEET:

- chromed soft self-braking castors d.50mm
- Leveler glides in polyamide, chromed finishes (15µm), black or white
- h.68mm Termoplastic polimer gliders chromed finish (15µm)
- polypropylene plugs, black or white finish

1. DOSSIER:

Monocoque en multiplie de hêtre ou chaine, finition laqué ou vernie ou en mousse revêtue

2. PIÈTEMENT:

- Piètement araigné 4 pieds en tube d'acier Ø 20mm, finition chromé (15µm)
- Piètement 4 pieds en tube d'acier Ø 12mm, finition chromé (15µm)
- Piètement luge en tube d'acier Ø 16mm, finition chromé (15µm)

3. ROULETTES/PATINS:

- roulettes d.50mm chromées gommées autofrein.
- Patins articulés et polyamide, finition chromée (15µm), noir ou blanc
- Patins en polymère thermoplastique, h.68mm, finition chromée (15µm)
- Tampons en polypropylène, finition noir ou blanc

1. RÜCKENLEHNE:

Buchen oder Eichen Holzschale, lackiert, gefärbt oder ausgepolstert mit Schwamm

2. GESTELL:

- 4-Fuß Drehkreuz, Ø20 mm Stahlrohr, verchromt (15µm)
- 4-Fuß Gestell, Ø12mm Stahlrohr, verchromt (15µm)
- Kufengestell, Ø 16mm Stahlrohr, verchromt (15µm)

3. ROLLEN/GLEITER:

- verchromte weiche gebremste Rollen D. 50mm
- Gelenkgleiter aus Polyamid, verchromt (15µm), schwarz oder weiss
- Thermoplastische Polymergleiter, H.68 mm, verchromt (15µm)
- polyamid gleiter, schwarze oder weisse



99%

EN 1728

EN 16139

5 YEAR WARRANTY



Certification and guarantee of absolute product quality



ISO 9001:2008 Quality



ISO 14001:2004 Environmental



OHSAS 18001:2007 Safety

Zaira

design: AZ Creations

ZAIRA è sgabello con base a slitta, per arredamenti ed esigenze particolari. Una seduta robusta e accattivante, ma che riscopre un lato allegro e “easy” nel rivestimento, il quale può essere laccato o tappezzato, con la possibilità di scegliere tra molti colori moderni e decisi.

ZAIRA is stool with sled base for furniture and special needs. a robust and captivating seat, but rediscovers a cheerful and “easy” side in the lining, which can be varnished or lacquered, with the choice of many modern and decisive colors.

ZAIRA est un tabouret en pieds luge, pour d’ameublements et exigences particulières. Une assise robuste et captivante, qui aperçoit un côté joyeux et « easy » dans les revêtements laqué ou tapissé, parmi de plusieurs couleurs modernes et fortes.

ZAIRA ist ein Hocker mit Kufen Gestell für Ausstattungen mit besondere Bedürfnisse. Ein robuster und beeindruckenden Stuhl, wiederendeckt aber eine fröhliche und leichte Seite in der Oberfläche mit den erhältlichen verschiedenen modernen Farben oder gepolstert.



Zaira

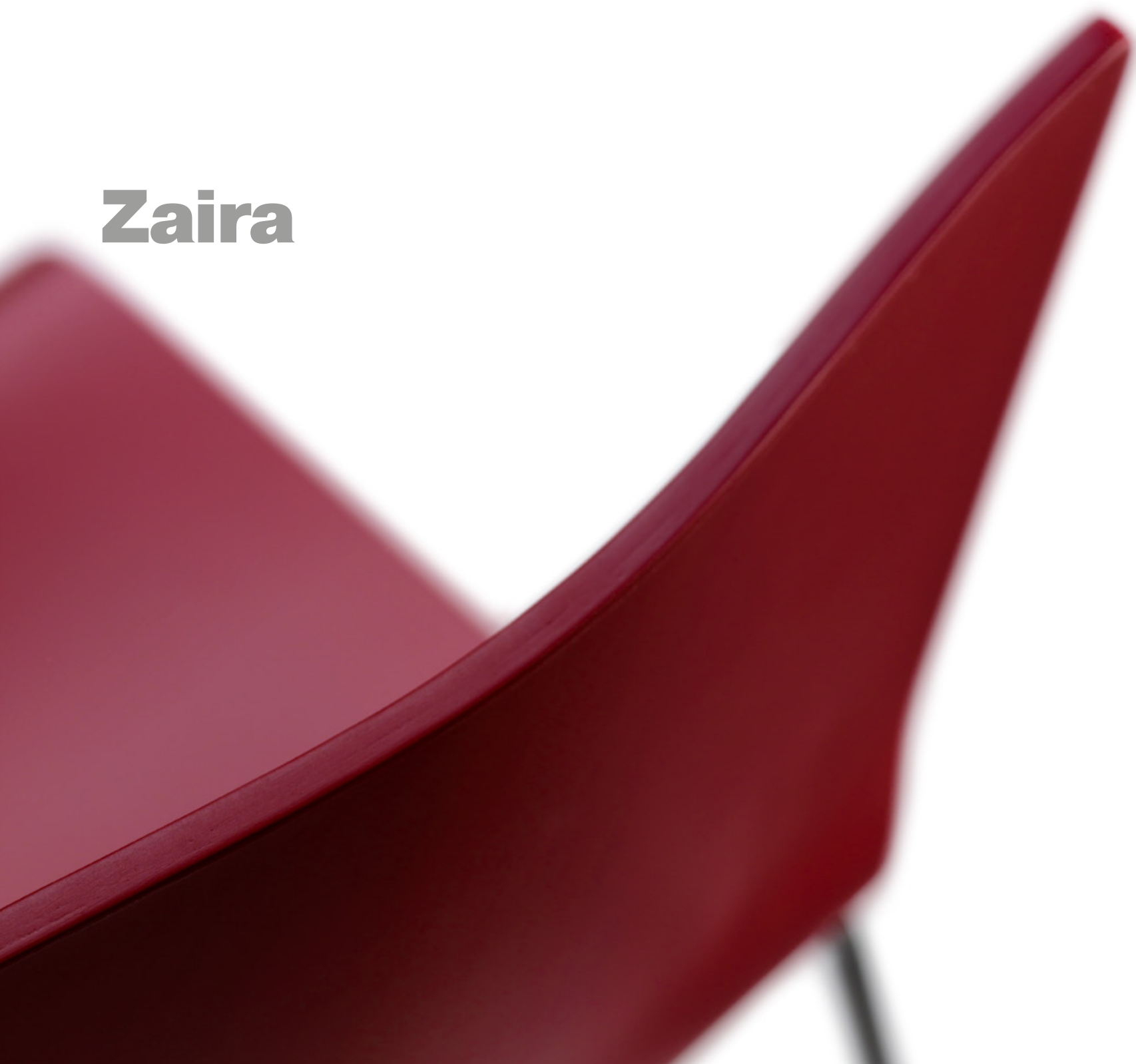

Zaira

Scocca in legno, struttura in metallo.
Laccata o tappezzata liscia.

Wooden shell, metal structure.
Lacquered or upholstered.

Coque en bois, structure en métal.
Laqué ou tapissée simple.

Holzschale, Metallgestell.
Lackiert oder gepolstert ohne
Steppungen.

versions

Zaira
Low Stool



Zaira
Stool



Zaira



BUSINESS
collection

Zaira

Stool

technical data



stool
sled base

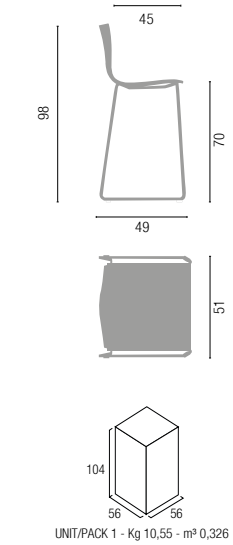

stool
low sled base

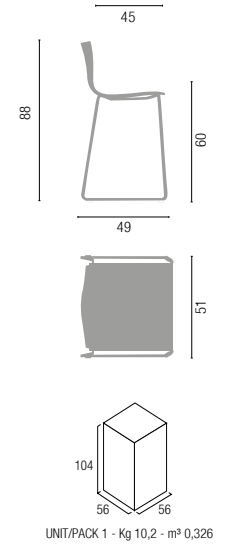

base



Base a slitta sgabello basso cromata
Chromed lower sled stool base
Piët. Bas luge tabouret chromé
Hocker Kufengestell, niedrig, verchromt

feet



Base a slitta sgabello cromata
Chromed stool sled base
Piët. luge tabouret chromé
Hocker Kufengestell verchromt

1. SCHIENALE:

Monoscocca in multistrato di faggio, finitura laccata o imbottita in spugna rivestita in tessuto

2. BASE:

Base a slitta sgabello in tondo d'acciaio Ø 12mm, finitura cromata (15µm)

3. PIEDINI:

Tappi in polipropilene, finitura bianca

1. BACKREST:

Bleach plywood monocoque, lacquered, or foam padded, fabric upholstery

2. BASE:

Stool cantilever base, Ø 12mm steel round bar, chromed finish (15µm)

2. FEET:

Polypropylene plugs, white finish

1. DOSSIER:

Monocoque en multiplie de hêtre, finition laqué ou rembourrée de mousse et tapissée

2. PIÈTEMENT:

Piètement luge tabouret en tube d'acier Ø 12mm, finition chromé (15µm)

2. PATINS:

Tampons en polypropylène, finition blanc

1. RÜCKENLEHNE:

Buchenholzschale, lackiert oder ausgepolstert mit Schwamm und Stoffbezug

2. GESTELL:

Hocker Kufengestell, Ø12mm Stahlstab, verchromt (15µm)

2. GLEITER:

Polypropylen Gleiter, weiss



EN 1728

EN 16139

5
YEAR
WARRANTY



Certification and guarantee of absolute product quality

Management System

Quality

Environmental

Safety

Edgar, Otello & Nabucco

design:
AZ Creations

EDGAR, OTELLO e NABUCCO sono tavoli dalle linee sinuose e leggere, con al contempo un design deciso, capaci di comunicare eleganza e imponenza allo stesso tempo. Tavolini da attesa e da bar, tavoli operativi, riunioni e conferenze, sono molteplici le varianti che questi prodotti offrono grazie alle varie altezze delle gambe e grandezze del piano. Il piano in legno e la gamba con il cuore d'acciaio gli donano un'essenza robusta, e la finitura laccata quasi soft touch li rende preziosi e moderni.

EDGAR, OTELLO and NABUCCO are tables with light and sinuous lines, with a strong design, capable of communicating elegance and grandeur at the same time. Coffee tables and bar tables, desk tables, meetings and conferences are many variants that these products offer thanks to the various heights of the legs and the size of the top. The wooden surface and the steel heart leg give it a robust essence, and the almost soft touch lacquering makes them precious and modern.

EDGAR, OTELLO et NABUCCO sont des tables caractérisées par des lignes sinueuses et légères mais aussi avec un design marqué, capables de communiquer un sens d'élégance et de grandeur en même temps. Petites tables d'accueil et bar, postes de travail, réunion et conférence, ce sont les nombreuses variantes offerte par ces tables grâce aux différentes hauteurs des piétements et dimensions des plateaux. Le plateau en bois et le piétement en acier confèrent une essence robuste, tandis que la finition laquée les fait précieuses et modernes.

EDGAR, OTELLO und NABUCCO sind Tische mit leichte und gewundenen Linien, gleichzeitig auch ein entscheidendes Design welches in der Lage ist, Eleganz und Erhabenheit zu vermitteln. Warte- und Stehtische, Besprechungs- und Konferenztische sind mehrere Varianten, die Dank der verschiedenen Höhe der Beine und der Größe der Tischflächen anzubieten sind. Die Holztafel und der Stahltellerfuß geben eine robuste Essenz. Die fast weiche Lackoberfläche machen sie wertvoll und modern.

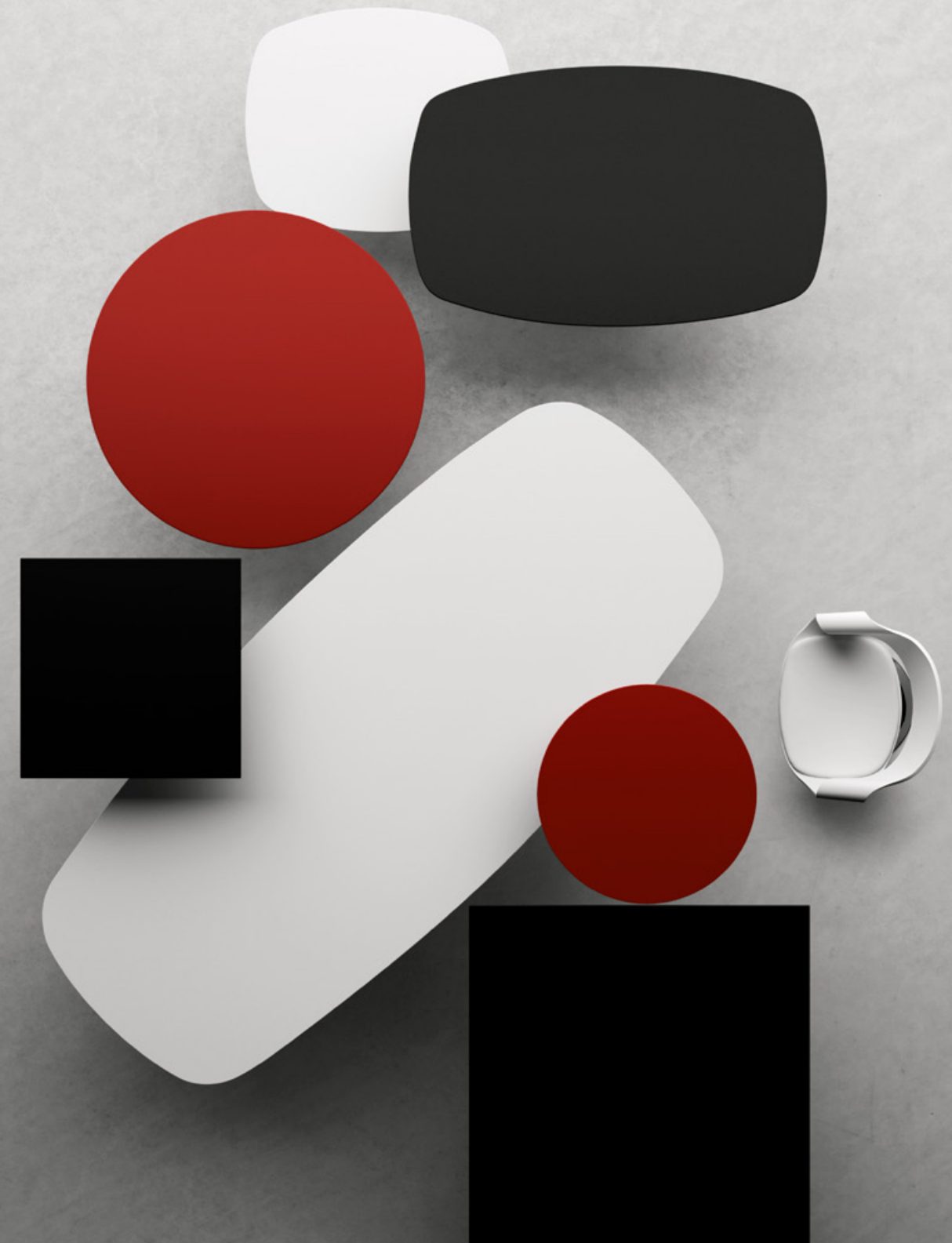

Edgar

Square



Edgar

Square



Piano in MDF laccato sp. 28mm,
base in acciaio laccata.
80x80 cm / 130x130 cm

MDF lacquered top, th. 28mm, steel
base.
80x80 cm / 130x130 cm

Plateau en MDF laqué, ép.28mm,
piétement en acier.
80x80 cm / 130x130 cm

Lackierte MDF Tischplatte, D. 28
mm, Stahlfuß.
80x80 cm / 130x130 cm

versions



Edgar

Square



Edgar

Square



Edgar

Square



Edgar

Square



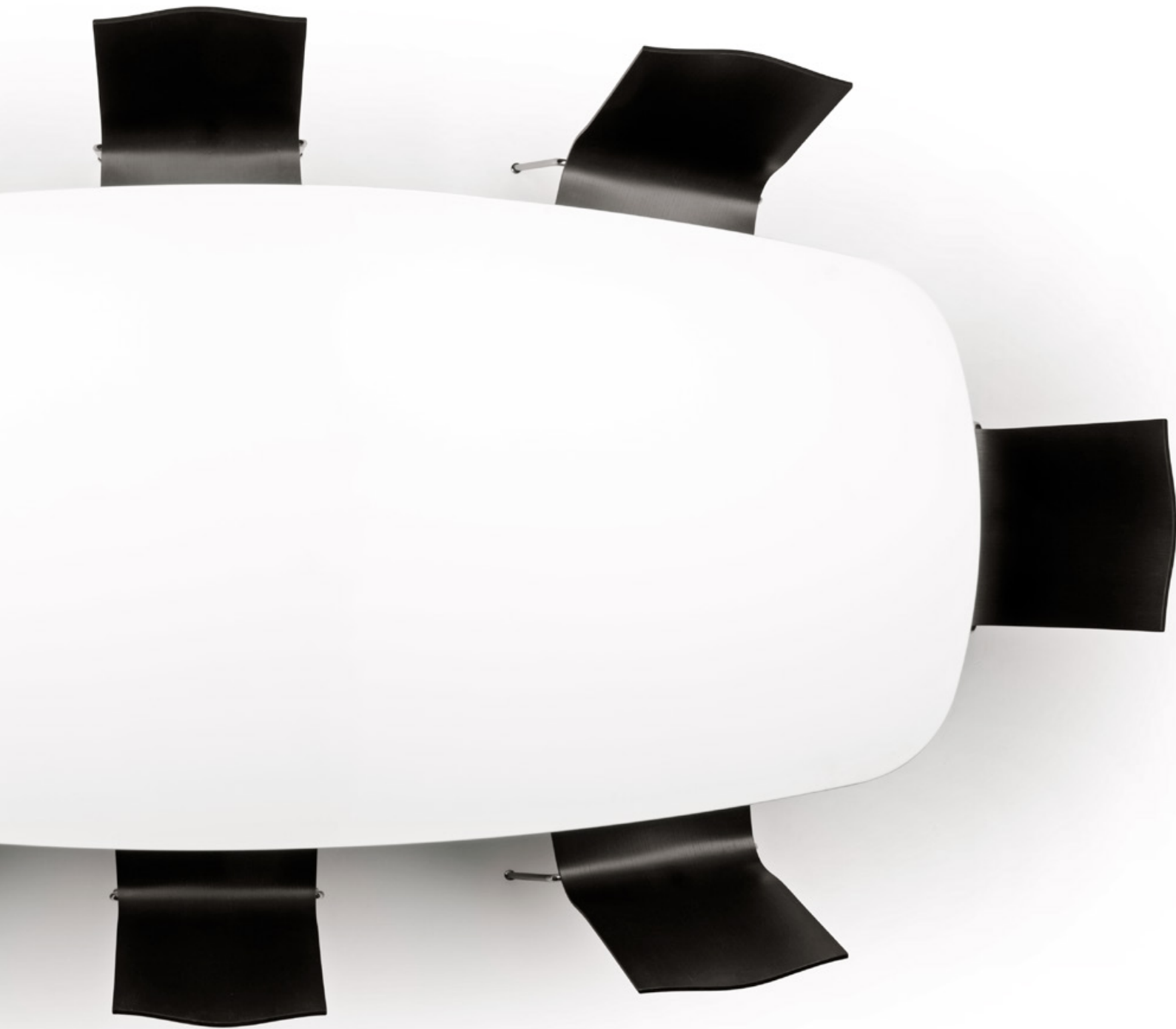

Nabucco

Oval

Piano in MDF laccato sp. 28mm, base in acciaio laccata.
90x110 cm / 100x160 cm / 130x300 cm

MDF lacquered top, th. 28mm, steel base.
90x110 cm / 100x160 cm / 130x300 cm

Plateau en MDF laqué, ép.28mm, piétement en acier.
90x110 cm / 100x160 cm / 130x300 cm

Lackierte MDF Tischplatte, D. 28 mm, Stahlfuß.
90x110 cm / 100x160 cm / 130x300 cm

versions



Nabucco

Oval



Nabucco

Oval



Nabucco

Oval



Otello

Round

Otello

Round

Piano in MDF laccato sp. 28mm, base in acciaio laccata.
Ø 80 cm / Ø 130 cm

MDF lacquered top, th. 28mm, steel base.
Ø 80 cm / Ø 130 cm

Plateau en MDF laqué, ép.28mm, piétement en acier.
Ø 80 cm / Ø 130 cm

Lackierte MDF Tischplatte, D. 28 mm, Stahlfuß.
Ø 80 cm / Ø 130 cm



versions



Otello

Round



Otello

Round



Edgar

Square

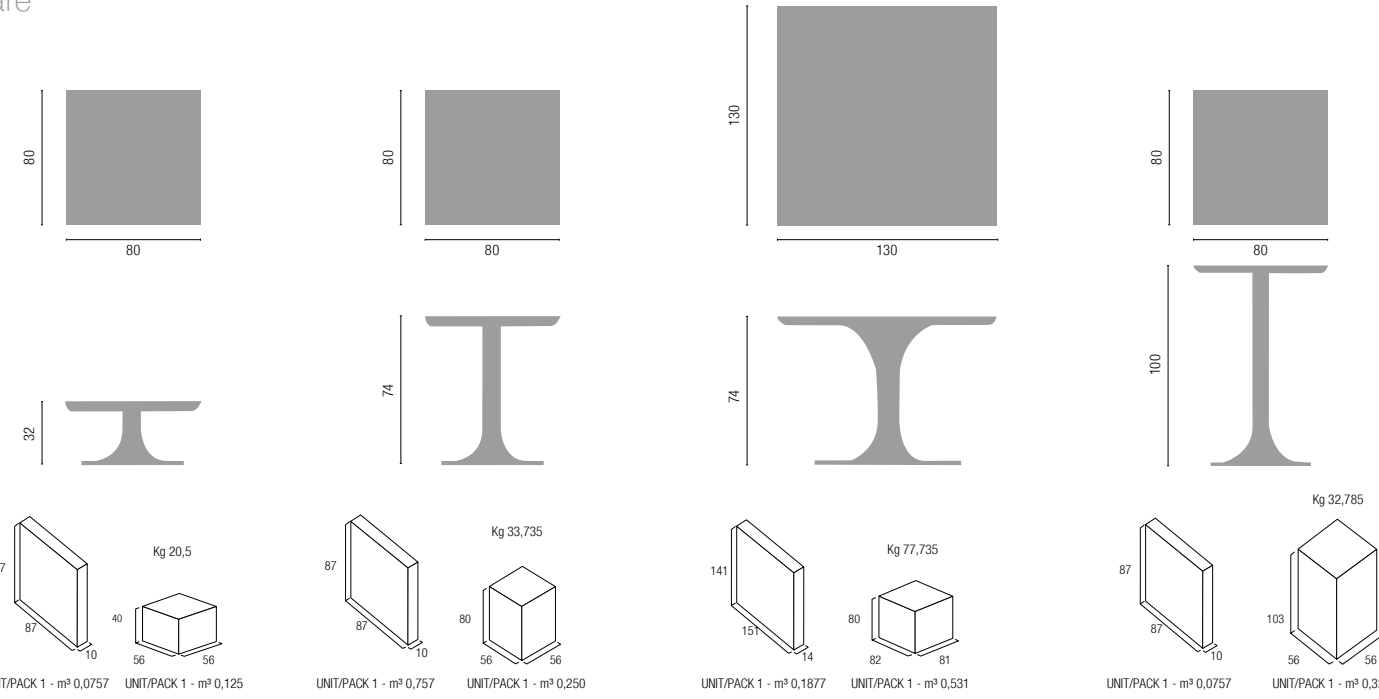

technical data

base

feet



Gamba a cono attesa altezza 32 cm
Cone base h. 32 cm
Pièt. tulipe haut. 32 cm
Tellerfuß H. 32 cm

Gamba a cono altezza 74 cm
Cone base h. 74 cm
Pièt. tulipe haut. 74 cm
Tellerfuß H. 74 cm

Gamba a doppio cono altezza 74 cm
Double-cone base h. 74 cm
Pièt. double tulipe haut. 74 cm
Doppel Tellerfuß H. 74 cm

Gamba a cono altezza 100 cm
Cone base h. 100 cm
Pièt. tulipe haut. 100 cm
Tellerfuß H. 100 cm

TOP:
Piano in MDF, sp. 28mm, 800x800mm o 1300x1300mm, finitura laccata

BASE:

- Gamba a cono in acciaio, h. 740mm, finitura laccata
- Gamba a cono in acciaio, h. 1000mm, finitura laccata
- Gamba a cono in acciaio, h. 320mm, finitura laccata
- Gamba a doppio cono in acciaio, h. 740mm, finitura laccata

TOP:
28mm thk MDF top, 800x800mm or 1300x1300mm laquered finish

BASE:

- Steel cone Base, h. 740 mm, lacquered finish.
- Steel cone Base, h. 1000 mm, lacquered finish.
- Steel cone Base, h. 320 mm, lacquered finish.
- Steel double-cone Base, h. 740 mm, lacquered finish.

PIÈTEMENT:

- Piètement tulipe en acier, h.740mm, finition laqué
- Piètement tulipe en acier, h.1000mm, finition laqué
- Piètement tulipe en acier, h.320mm, finition laqué
- Piètement double tulipe en acier, h.740mm, finition laqué

TOP:
Lackierte MDF Tischplatte, D. 28 mm, 800x800 mm oder 1300x1300 mm

GESTELL:

- Stahl Tellerfuß, h 740mm, lackiert
- Stahl Tellerfuß, h 1000mm, lackiert
- Stahl Tellerfuß, h 320mm, lackiert
- Doppel Stahl Tellerfuß, h 740mm, lackiert



Nabucco

Oval

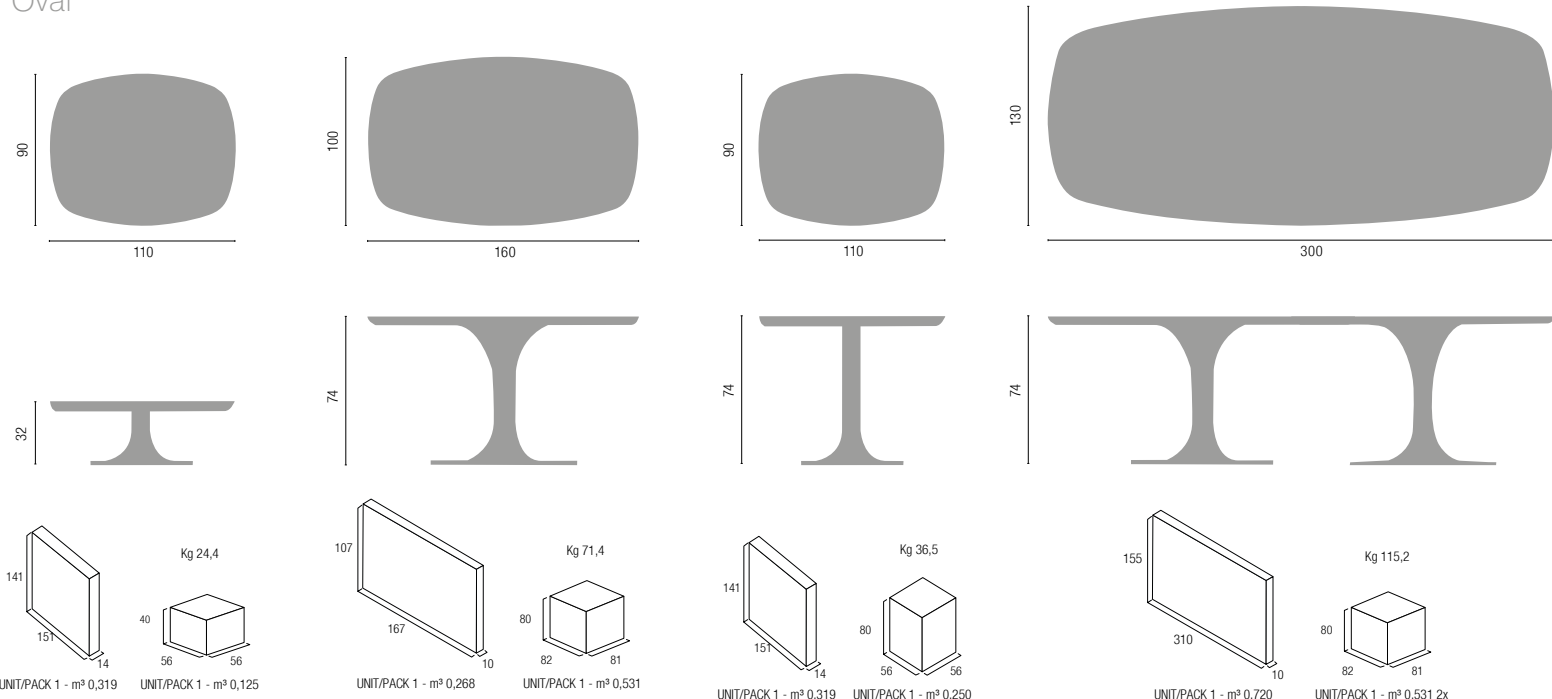

technical data

base

feet



Gamba a cono altezza 74 cm
Cone base h. 74 cm
Pièt. tulipe haut. 74 cm
Tellerfuß H. 74 cm

Gamba a doppio cono altezza 74 cm
Double-cone base h. 74 cm
Pièt. double tulipe haut. 74 cm
Doppel Tellerfuß H. 74 cm

Gamba a cono altezza 100 cm
Cone base h. 100 cm
Pièt. tulipe haut. 100 cm
Tellerfuß H. 100 cm

TOP:
Piano in MDF, sp. 28mm, 900x1100mm, 1000x1600mm o 1300x3000mm, finitura laccata

BASE:

- Gamba a cono in acciaio, h. 740mm, finitura laccata
- Gamba a cono in acciaio, h. 320mm, finitura laccata
- Gamba a doppio cono in acciaio, h. 740mm, finitura laccata

TOP:
28mm thk MDF top, 900x1100mm, 1000x1600mm, 1300x3000 laquered finish

BASE:

- Steel cone Base, h. 740 mm, lacquered finish.
- Steel cone Base, h. 320 mm, lacquered finish.
- Steel double-cone Base, h. 740 mm, lacquered finish.

PIÈTEMENT:

- Piètement tulipe en acier, h.740mm, finition laqué
- Piètement tulipe en acier, h.320mm, finition laqué
- Piètement double tulipe en acier, h.740mm, finition laqué

TOP:
Plateau en MDF, épaisseur 28mm, 900x1100mm, 1000x1600mm ou 1300x3000mm, finitura laccata

GESTELL:

- Stahl Tellerfuß, h 740mm, lackiert
- Stahl Tellerfuß, h 320mm, lackiert
- Doppel Stahl Tellerfuß, h 740mm, lackiert



Otello

Round

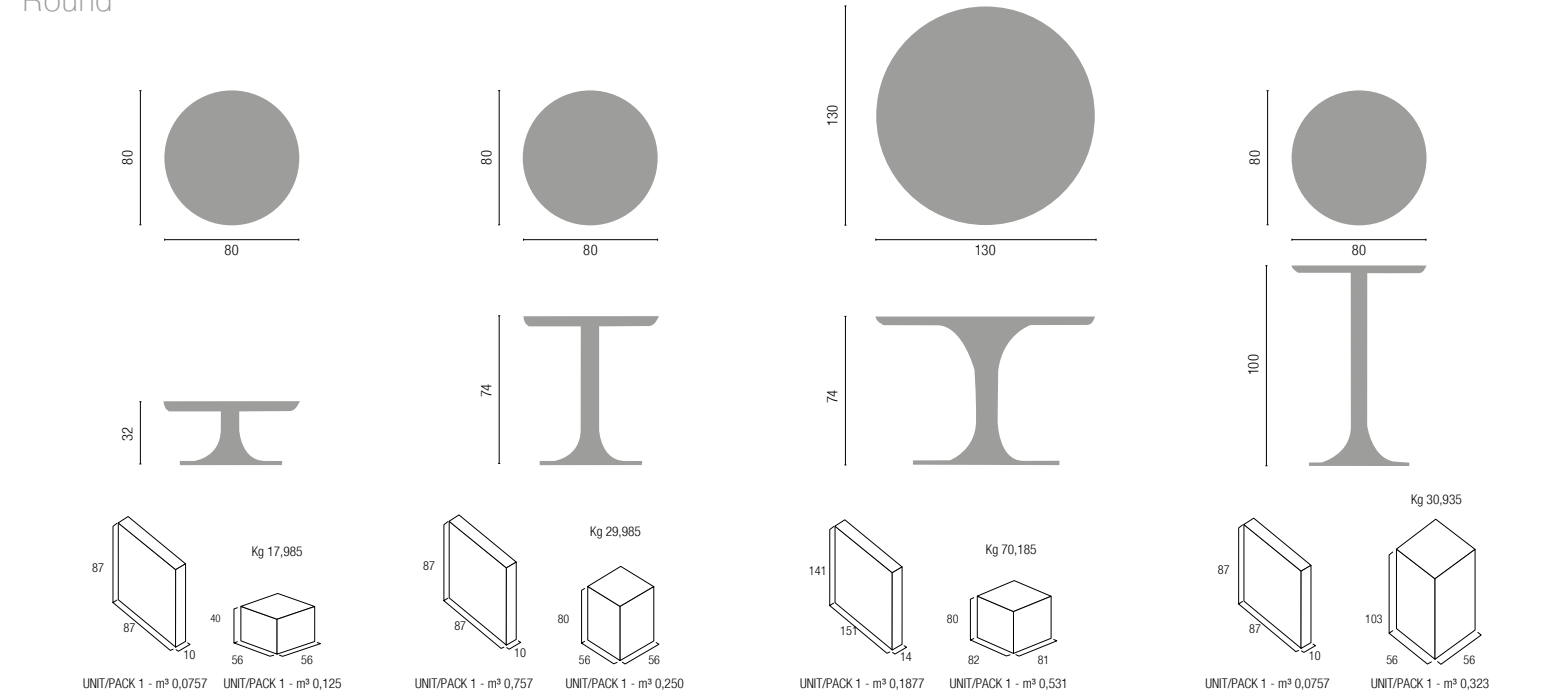

technical data

base

feet



Gamba a cono attesa altezza 32 cm
Cone base h. 32 cm
Pièt. tulipe haut. 32 cm
Tellerfuß H. 32 cm

Gamba a cono altezza 74 cm
Cone base h. 74 cm
Pièt. tulipe haut. 74 cm
Tellerfuß H. 74 cm

Gamba a doppio cono altezza 74 cm
Double-cone base h. 74 cm
Pièt. double tulipe haut. 74 cm
Doppel Tellerfuß H. 74 cm

Gamba a cono altezza 100 cm
Cone base h. 100 cm
Pièt. tulipe haut. 100 cm
Tellerfuß H. 100 cm

TOP:
Piano in MDF, sp. 28mm, 900x1100mm, 1000x1600mm o 1300x3000mm, finitura laccata

BASE:

- Gamba a cono in acciaio, h. 740mm, finitura laccata
- Gamba a cono in acciaio, h. 1000mm, finitura laccata
- Gamba a cono in acciaio, h. 320mm, finitura laccata
- Gamba a doppio cono in acciaio, h. 740mm, finitura laccata

TOP:
28mm thk MDF top, 900x1100mm, 1000x1600mm, 1300x3000 laquered finish

BASE:

- Steel cone Base, h. 740 mm, lacquered finish.
- Steel cone Base, h. 1000 mm, lacquered finish.
- Steel cone Base, h. 320 mm, lacquered finish.
- Steel double-cone Base, h. 740 mm, lacquered finish.

PIÈTEMENT:

- Piètement tulipe en acier, h.740mm, finition laqué
- Piètement tulipe en acier, h.1000mm, finition laqué
- Piètement tulipe en acier, h.320mm, finition laqué
- Piètement double tulipe en acier, h.740mm, finition laqué

TOP:
Plateau en MDF, épaisseur 28mm, 900x1100mm, 1000x1600mm ou 1300x3000mm, finitura laccata

GESTELL:

- Stahl Tellerfuß, h 740mm, lackiert
- Stahl Tellerfuß, h 1000mm, lackiert
- Stahl Tellerfuß, h 320mm, lackiert
- Doppel Stahl Tellerfuß, h 740mm, lackiert



Otello, Nabucco & Edgar





Zip
488



Era
498



Pretty
504



Zip

design: AZ Creations

ZIP è una famiglia di sedute a quattro gambe impilabile adatta alle sale da attesa; Zip è un modello essenziale che sposa la funzionalità, ottenendo un connubio all'insegna della semplicità e della praticità. È disponibile con braccioli fissi in poliamide oppure in metallo, su questi ultimi è possibile fissare una tavoletta. Sedile e schienale possono essere tappezzati per fornire maggior comfort e personalità; ZIP è disponibile anche su trave.

ZIP is a family of 4-leg stackable chairs which is particularly suitable for waiting rooms; Zip is an essential model that combines functionality, simplicity and usefulness. It is available with fixed arms in polyamide or with metal armrest, on these ones you can also apply a writing tablet as option. Seat and back can be upholstered in order to provide greater comfort and personality; ZIP is also available on bench.

ZIP est une famille de chaises empilables 4 pieds désignée surtout pour les salles d'attente ; Zip est un modèle essentiel qui combine fonctions, simplicité et utilité pratique. Zip est disponible avec accoudoirs fixes en polyamide ou en métal ; sur ces derniers c'est possible de fixer une tablette écrite. Dossier et assise peuvent être tapissés pour offrir plus de confort et personnalité. Zip est également disponible en version poure.

ZIP ist eine 4-Fuss Stapelstuhlfamilie, die besonders für Wartezimmer geeignet ist; Zip ist ein wesentliches Modell und umfängt verschiedene Funktionalitäten. Einfach und praktisch mit Polyamid Armlehnen verfügbar oder aus Metall. Auf den Metall Armlehnen kann man eine Schreibtabelle befestigen. Sitz und Rücklehne können gepolstert werden um einen zusätzlichen besseren Komfort und Persönlichkeit anzubieten. ZIP ist auch in der Version Sitzbank zu haben.

Zip

Polypropylene



Zip

Fissa, sedile e schienale in polipropilene, struttura in metallo. Schienale tappezzato basso, schienale tappezzato alto.

Visitor, polypropylene seat and backrest, metal structure. Low uphol. backrest, high uphol. backrest.

Visiteur, assise et dossier en polypropylène, structure en métal. Dossier bas tapissé, dossier haut tapissé.

Besucher, Sitz und Rückenlehne aus Polypropylen, Metallg. Niedrige gepolst. Rückenl., hohe gepolst. Rückenl.

versions

Zip
Polypropylene

Zip
Castors

Zip
Upholstered

Zip
Bench

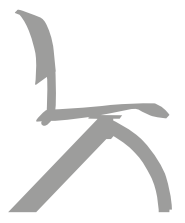

Zip
Polypropylene



Zip
Polypropylene





Zip

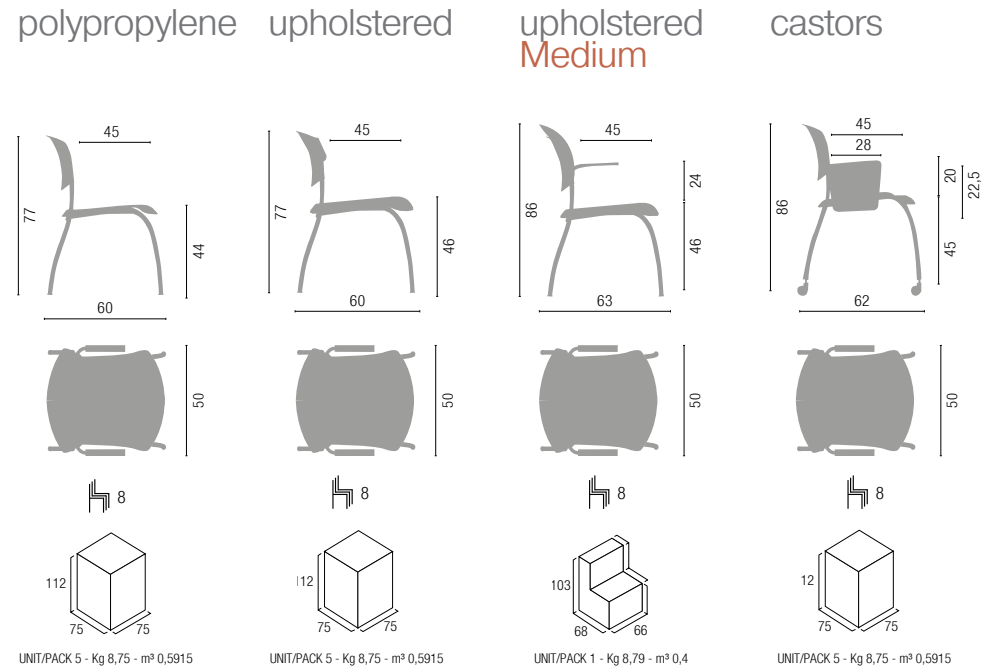

technical data

Schienale tappezzato basso
Low uphol. backrest
Dossier bas tapissé
Niedrige gepolst. Rückenl.

Schienale tappezzato alto
High uphol. backrest
Dossier haut tapissé
Hohe gepolst. Rückenl.

base



Base 4 gambe cromata
4-legs chromed base
Pièd. 4 pieds chromé
4-Fuß Gestell verchromt



Base 4 gambe vern. nera
4-legs black painted base
Pièd. 4 pieds verni noir
4-Fuß Gestell schwarz



Base 4 gambe vern. grigia
4-legs grey painted base
Pièd. 4 pieds verni gris
4-Fuß Gestell grau

castors/feet



options



XB074 - polyamide arm.



XB043 - grey
XB044 - chromed
XB045 - black

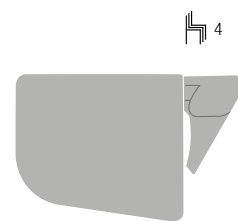

XS003 - writing tablet

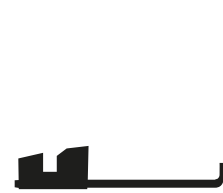

linking device
XA003 - seat
XA004 - armrest



1. SCHIENALE:

Schienale e sedile in polipropilene, a vista o imbottita con spugna rivestita in tessuto

2. BASE:

Base 4 gambe in tubo d'acciaio Ø 22mm, finitura cromata (15µm) o verniciata a polveri

3. RUOTE/PIEDINI:

- Ruote Ø 50mm, autofrenanti o autofrenanti e gommate, finitura nera
- Tappi in polipropilene, finitura nera

4. BRACCIOLI:

- Bracciolo fisso in poliamide, finitura nera
- Bracciolo fisso in tubo tondo d'acciaio, Ø 16mm, finitura cromata (15µm) o verniciata a polveri, con top in poliamide, finitura nera

1. BACKREST:

Seat and backrest in polypropylene, or foam padded, fabric upholstery

2. BASE:

4 Legs base, Ø 22 mm steel tube, chromed finish (15µm) or powder coated

3. CASTORS/FEET:

- Ø 50 mm self-braking castors, or soft self-braking. Black finish
- polypropylene plugs, black finish

4. ARMREST:

- Polyamide fixed armrest, black finish
- Fixed armrest, round steel tube, Ø 16mm, chromed finish (15µm), or powder coated, polyamide top pad, black finish

1. DOSSIER:

Assise et dossier en polypropylène à vue ou rembourrés de mousse et tapissés

2. PIÈTEMENT:

Piètement 4 pieds en tube d'acier Ø 22mm, finition chromé (15µm) ou verni époxy

3. ROULETTES/PATINS:

- Roulettes Ø 50mm, autofreinantes ou autofreinantes et gommées, finition noir
- tampons en polypropylène, finition noir

4. ACCUDOIRS:

- Accoudoir fixe en polyamide, finition noir
- Accoudoir fixe en tube rond d'acier, Ø 16mm, finition chromée (15µm) ou verni époxy, manchette en polyamide, finition noir

1. RÜCKENLEHNE:

Polypropylen Sitz und Rückenlehne, oder ausgepolstert mit Schwamm und Stoffbezug

2. GESTELL:

4-Fuß Gestell, Ø 22mm Stahlrohr, verchromt (15µm) oder pulverbeschichtet

3. ROLLEN/GLEITER:

- Ø 50 mm gebremste, oder weiche gebremste Rollen, schwarz
- polyamid gleiter, schwarz

4. ARMLEHNEN:

- Feste schwarze Polyamid Armlehne
- Feste schwarze Polyamid Armlehne, Ø 16 mm, verchromt (15 µm) oder pulverbeschichtet, schwarze Polyamid Armauflage



93,5 %

EN 1022

EN 1728

EN 16139

EN 9175

5 YEAR WARRANTY





Zip

bench

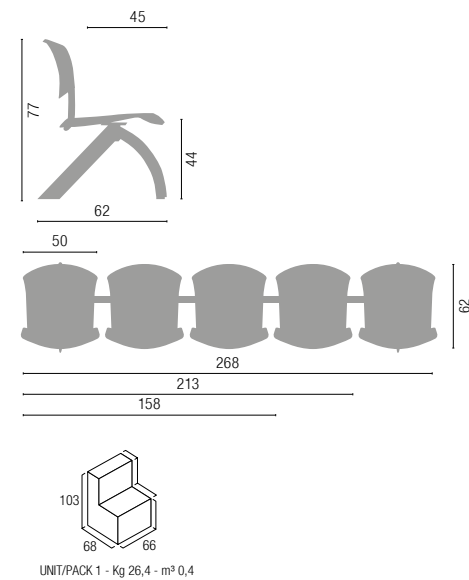

technical data

Zip

Bench



Trave vern. nera con gambe vern. nere
Black painted bench, black painted frame
 Poutre vernie noire avec pièt. verni noir
Schwarz pulverb., Fußge. schwarz pulverb.



Trave 5P vern. nera con gambe vern. grigie
5 seats black painted bench, grey painted frame
 Poutre 5 places vernie noire avec pièt. verni gris
5 Sitzträger schwarz pulverb., Fußgestell grau pulverb.



Trave vern. nera con gambe cromate
Black painted bench, chromed frame
 Poutre vernie noire avec pièt. chromé
3 Sitzträger schwarz pulverb., Fußgestell verchromt



1. SCHIENALE:
 Trave 3/4/5 con schienale e sedile in polipropilene a vista
2. BASE:
 Trave in tubo rettangolare d'acciaio, 80x40mm, finitura verniciata a polveri, con gambe in tubo d'acciaio, finitura cromata (15µm) o verniciata a polveri
4. PIEDINI:
 Tappi in polipropilene, finitura nera

1. BACKREST:
 3/4/5 seats bench, seat and backrest in polypropylene
2. BASE:
 Rect. Steel tube bar 80x40mm, powder coated, with steel tube legs, chromed finish (15µm) or powder coated
4. FEET:
 Polypropylene plugs, black finish

1. DOSSIER:
 Poutre 3/4/5 places avec dossier et assise en polypropylène à vue
2. PIETEMENT:
 Poutre en tube d'acier rectangulaire, 80x40mm, finition verni époxy, avec pieds en tube d'acier, finition chromé (15µm) ou verni époxy
4. PATINS:
 Tampons en polypropylène, finition noir

1. RÜCKENLEHNE:
 3/4/5 Sitzbank, Polypropylen Sitz und Rückenlehne
2. GESTELL:
 Vierkantstahlrohr Träger 80x40mm pulverbeschichtet mit Stahlrohr Fuß Gestell verchromt (15µm) oder pulverbeschichtet
6. GLEITER:
 Polyamid gleiter, schwarz



Era

design: AZ Creations

ERA è una seduta da attesa a quattro gambe impilabile; è una seduta flessibile in tutti gli aspetti, sia per la sua particolare struttura che permette di mantenere un appoggio a terra ottimale anche in caso di pavimentazione non perfettamente piana, sia per la sua forma snella e vivace, che si adatta a vari contesti. ERA può essere anche tappezzata per maggiore comfort e originalità; come optional è possibile applicare una tavoletta.

ERA is a 4-leg stackable waiting chairs; this seating is flexible in all its aspects, both for its particular structure that maintains a parallel ground contact even with an irregular floor both for its slim and lively shape, which is suitable for various contexts. ERA can be upholstered for more comfort and originality; as an option you can also add a writing tablet.

ERA est une famille de chaises d'attente 4 pieds empilables ; il s'agit d'une chaise flexible dans tous les aspects, tant pour sa structure particulière qui permet de maintenir un bon appui à terre, même si le sol n'est pas parfaitement plat, tant pour sa forme mince et vive, qui bien s'adapte à différents contextes. ERA peut être tapissé pour plus de confort et d'originalité ; comme option on peut y appliquer une tablette écrite.

ERA ist ein Stapelbaren 4-Fuß Besucherstuhl. Es handelt sich um einen flexiblen Stuhl in jeder Hinsicht, sei es wegen seine besondere Struktur welche sich stabil zu jede unebene Bodenfläche anpasst, oder sei es seiner schlanke und lebhafte Form die in verschiedenen Bereiche seine Verwendbarkeit ermöglicht. Zu einen besseren Komfort kann ERA auch ausgepolstert werden und unter Optionen kann man eine Schreibplatte wählen.



Era



Era

Fissa, struttura in metallo. Schienale e sedile in polipropilene o tappezzati.

Visitor, metal structure. Backrest and seat in polypropylene or upholstered.

Visiteur, structure en métal. Dossier et assise en polypropylène ou tapissés.

Besucher, Metallgestell. Rückenlehne und Sitz aus Polypropylen oder gepolstert.



versions

Era
4-legs





Era



4-legs

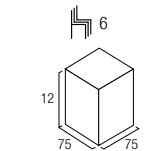
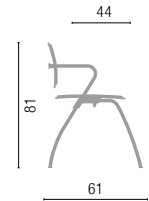

UNIT/PACK 3 - Kg 11,4 - m³ 0,5915

4-legs
Tablet

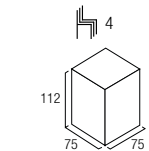
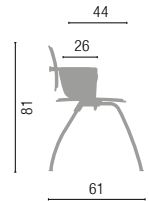

UNIT/PACK 3 - Kg 11,4 - m³ 0,5915

trolley

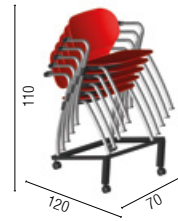

technical data



Gambe vern. nere
Black painted base
Piè. verni noir
Gestell schwarz lackiert

Gambe vern. grigie
Grey painted base
Piè. verni gris
Gestell grau lackiert

Gambe cromate
Chromed base
Piè. chromé
Gestell verchromt

options

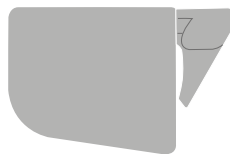

XS004 - writing tablet



linking device (writing tablet)
XA005 - seat
XA006 - armrest



trolley
XA008

- 1. SCHIENALE E SEDILE:**
Schienale e sedile in polipropilene, a vista o imbottita con spugna rivestita in tessuto
2. BASE:
Base 4 gambe in tubo ellittico d'acciaio, 35x20mm, finitura cromata (15µm) o verniciata a polveri
3. RUOTE/PIEDINI:
Tappi in polipropilene, finitura nera
- 1. BACKREST AND SEAT:**
Polypropylene seat and backrest. Optionally foam padded and fabric upholstered
2. BASE:
4 legs base, 35x20mm ellipt. steel tube, chromed finish (15µm) or powder coated
3. CASTORS/FEET:
Polypropylene plugs, black finish
- 1. DOSSIER ET DOSSIER:**
Assise et dossier en polypropylène ou rembourrés de mousse et tapissée
2. PIÈTEMENT:
Piètement 4 pieds en tube elliptique d'acier, 35x20mm, finition chromé (15µm) ou verni époxy
3. ROULETTES/PATINS:
Tampons en polypropylène, finition noir
- 1. RÜCKENLEHNE UND SITZ:**
Rückenlehne und Sitz aus Polypropylen oder ausgepolstert mit Schwamm und Stoffbezug
2. GESTELL:
4-Fuß Gestell, 35x20 Elliptischstahlrohr, verchromt (15µm) oder pulverbeschichtet
3. ROLLEN/GLEITER:
Polyamid gleiter, schwarz



Particolare struttura che permette di mantenere un appoggio a terra ottimale anche in caso di pavimentazione non perfettamente piana
Particular structure that maintains a parallel ground contact even with an irregular floor
Particulière qui permet de maintenir un bon appui à terre, même si le sol n'est pas parfaitement plat
Seine besondere Struktur welche sich stabil zu jede unebene Bodenfläche anpasst



Pretty

design: AZ Creations

PRETTY è una seduta pieghevole disponibile in diversi colori; la struttura in ferro è disponibile verniciata nera, alluminio oppure cromata. È una seduta pratica e leggera, adatta ad ambienti piccoli. È disponibile un comodo carrello per il trasporto.

PRETTY is a foldable chair available in different colours; the iron frame is available in black or aluminum painting or chromed. It is a handy and light chair, especially suitable for small rooms. There is also a trolley available for an easy transport.

PRETTY est une chaise pliante disponible en différentes couleurs ; la structure en métal est disponible en époxy noir, en époxy gris aluminium ou chromé. Il s'agit d'une chaise pratique et légère, apte aux petits espaces. Il y a aussi un chariot pour faciliter le transport.

PRETTY ist ein Klappstuhl in verschiedenen Farben erhältlich. Das Stahlgestell ist in drei Farb-Varianten verfügbar; schwarz lackiert, aluminium lackiert oder verchromt. Es handelt sich um einen leichten und praktischen Stuhl der für Kleinräume geeignet ist. Um den Transport zu erleichtern gibt es auch einen bequemen Stuhlträger.



Pretty



Pretty

Fissa, sedile e schienale in polipropilene, pieghevole.

Visitor, seat and backrest in polypropilene, foldable.

Visiteur, assise et dossier en polypropylène.

Besucher, Sitz und Rückenlehne aus Polypropylen, klappbar.

versions

Pretty
Foldable





Pretty



legs

trolley

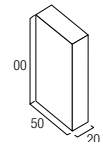
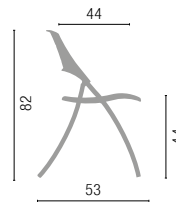

UNIT/PACK 2 - Kg 6,5 - m² 0,01

technical data

option

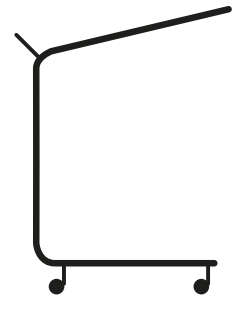

trolley
XA010



feet



1. SCHIENALE E SEDILE:
Schienale e sedile in polipropilene, a vista
2. BASE:
Base 4 gambe in tubo ovale d'acciaio, 25x12mm, finitura cromata (15µm) o verniciata a polveri
3. PIEDINI:
Tappi in polipropilene, finitura nera

1. BACKREST AND SEAT:
Polypropylene seat and backrest.
2. BASE:
4 legs base, 25x12mm oval steel tube, chromed finish (15µm) or powder coated
3. FEET:
Polypropylene plugs, black finish

1. DOSSIER ET DOSSIER:
Dossier et assise en polypropylène, à vue
2. PIÈTEMENT:
Piètement 4 pieds en tube ovale d'acier, 25x12mm, finition chromé (15µm) ou verni époxy
3. PATINS:
Tampons en polypropylène, finition noir

1. RÜCKENLEHNE UND SITZ:
Polypropylen Sitz und Rückenlehne.
2. GESTELL:
4-Fuß Gestell, 25x12mm ovaies Stahlrohr verchromt (15µm) oder pulverbeschichtet
3. GLEITER:
Polyamid gleiter, schwarz



Pretty

Trolley





TechnicalInformations

Mechanisms

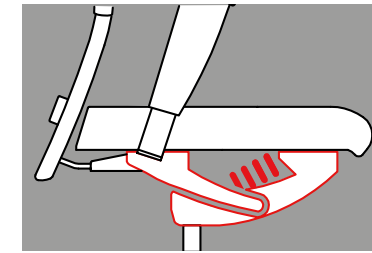

SynchroTeK

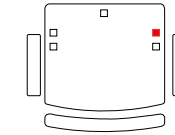

Regolatore di tensione del meccanismo
Tension adjustment of the mechanism
 Réglage d'intensité du mécanisme
Spannungsregler der Mechanik

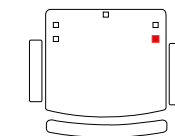
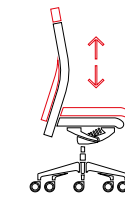

Regolazione in altezza della seduta
Height adjustment of the seat
 Réglage en hauteur de l'assise
Sitzhöhenverstellung

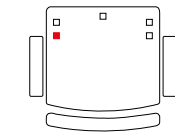
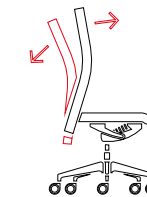

Blocco-sblocco oscillazione schienale
Locking-unlocking device of the backrest inclination
 Système de blocage-déblocage du dossier
Blockierungssystem der Rückenlehne

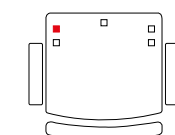
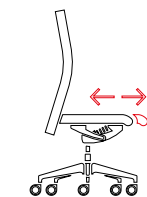

Regolazione in profondità del sedile
Depth adjustment of the seat
 Réglage en profondeur de l'assise
Sitztiefenverstellung

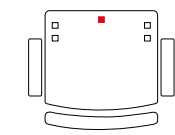
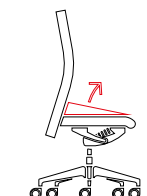

Regolatore d'assetto del sedile
Adjustment of seat negative inclination
 Inclinaison négative de l'assise
Sitzneigungsverstellung

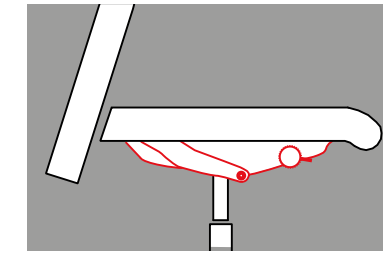

SynchroPlus⁺

TECH INSIDE. SIMPLE OUTSIDE

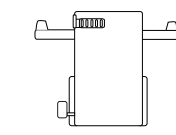
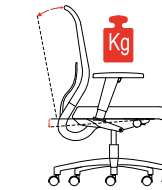

Regolatore di tensione del meccanismo
Tension adjustment of the mechanism
 Réglage d'intensité du mécanisme
Spannungsregler der Mechanik

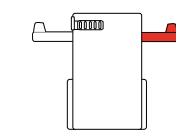
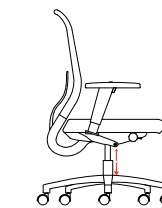

Regolazione in altezza della seduta
Height adjustment of the seat
 Réglage en hauteur de l'assise
Sitzhöhenverstellung

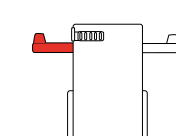
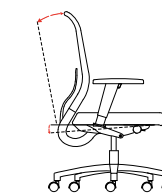

Sistema di blocco-sblocco oscillazione dello schienale
Locking-unlocking device of the backrest inclination
 Système de blocage-déblocage du dossier
Blockierungssystem der Rückenlehne

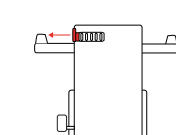
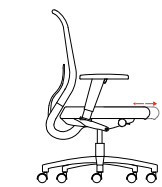

Regolatore profondità del sedile
Depth adjustment of the seat
 Réglage en profondeur de l'assise
Sitztiefenverstellung

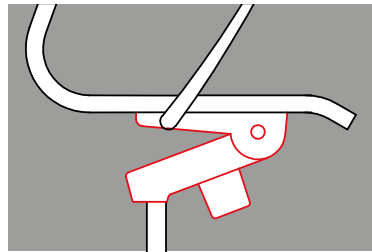

Tilting

Oscillante / Tilting mechanism
Basculant / Wippmechanik

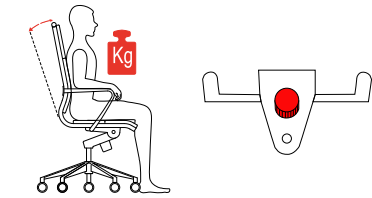

Regolatore di tensione del meccanismo
Tension adjustment of the mechanism
Réglage d'intensité du mécanisme
Spannungsregler der Mechanik

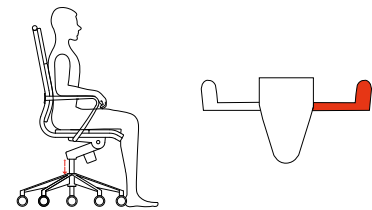

Regolazione in altezza della seduta
Height adjustment of the seat
Réglage en hauteur de l'assise
Sitzhöhenverstellung

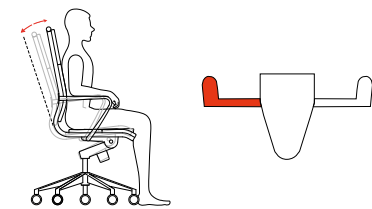

Sistema di blocco-sblocco oscillazione dello schienale
Locking-unlocking device of the backrest inclination
Système de blocage-déblockage du dossier
Blockierungssystem der Rückenlehne

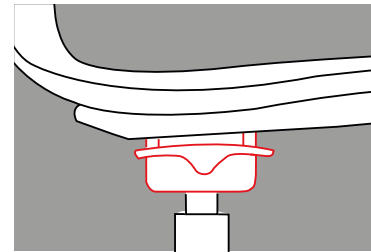

ErgoTeK

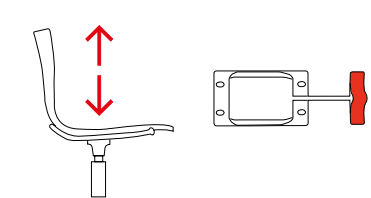

Regolazione in altezza della seduta
Height adjustment of the seat
Réglage en hauteur de l'assise
Sitzhöhenverstellung

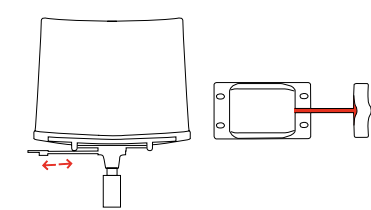

Sistema di blocco-sblocco oscillazione dello schienale
Locking-unlocking device of the backrest inclination
Système de blocage-déblockage basculant du dossier
Blockierungssystem der Rückenlehne

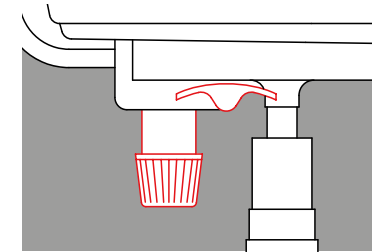

Mini-Synchro

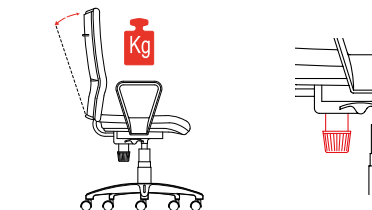

Regolatore di tensione del meccanismo
Tension adjustment of the mechanism
Réglage d'intensité du mécanisme
Spannungsregler der Mechanik



Regolazione in altezza della seduta
Height adjustment of the seat
Réglage en hauteur de l'assise
Sitzhöhenverstellung



Sistema di blocco-sblocco oscillazione dello schienale
Locking-unlocking device of the backrest inclination
Système de blocage-déblockage basculant du dossier
Blockierungssystem der Rückenlehne

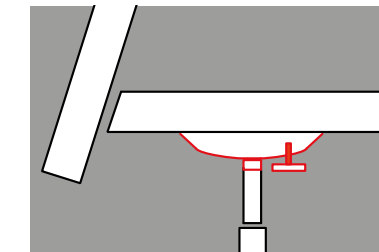

Seat-Plate

Piastra / Seat Plated / Platine / Sitzplatte

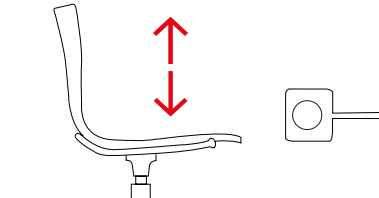

Regolazione in altezza della seduta
Height adjustment of the seat
Réglage en hauteur de l'assise
Sitzhöhenverstellung

Armrests



XB046

Braccioli regolabili in altezza top poliamide

Braccioli regolabili in altezza cm 6, con struttura in metallo verniciato nero e top in poliamide.

Height-adjustable armrests 6 cm stroke, with black painted metal structure and polyamide support.

Accoudoirs réglables en hauteur cm 6, avec structure en métal époxy noir et manchette en polyamide.

Höhenverstellbare Armlehnen, cm 6, mit schwarz lackierte Metallstruktur und Polyamid Armauflage.

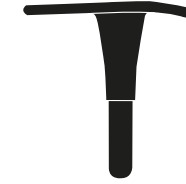

XB049

Braccioli regolabili in altezza top poliamide

Braccioli regolabili in altezza cm 6, con struttura in metallo verniciato nero e top in poliamide.

Height-adjustable armrests 6 cm stroke, with black painted metal structure and polyamide support.

Accoudoirs réglables en hauteur cm 6, avec structure en métal époxy noir et manchette en polyamide.

Höhenverstellbare Armlehnen, cm 6, mit schwarz lackierte Metallstruktur und Polyamid Armauflage.

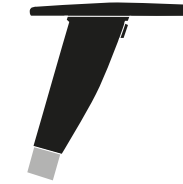

XB017

Braccioli regolabili in altezza cromati top poliamide

Braccioli regolabili in altezza cm 6, con struttura in metallo cromato e top in poliamide.

Height-adjustable armrests 6 cm stroke, with chromed metal structure and polyamide support.

Accoudoirs réglables en hauteur cm 6, avec structure en métal chromé et manchette en polyamide.

Höhenverstellbare Armlehnen, cm 6, mit schwarz lackierte Metallstruktur und Polyamid Armauflage.

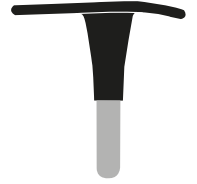

XB072

Braccioli regolabili in altezza cromati top poliamide

Braccioli regolabili in altezza cm 6, con struttura in metallo cromato con top poliamide.

Height-adjustable armrests 6 cm stroke, with chromed metal structure and polyamide support.

Accoudoirs réglables en hauteur cm 6, avec structure en métal chromé et manchette en polyamide.

Höhenverstellbare Armlehnen, cm 6, mit verchromte Metallstruktur und Polyamid Armauflage.

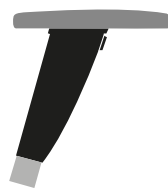
**XB025 / XB084**

Braccioli regolabili
2D / 3D cromati
top poliamide

XB025

Braccioli 2D regolabili in altezza cm 6, traslazione top bracciolo cm 5, con struttura in metallo cromato, top morbido in poliuretano.

2D adjustable armrests (height 6 cm, depth 5 cm) with chromed metal structure and polyamide support, with polyurethane soft pad.

Accoudoirs 2D réglables en hauteur cm 6 et profondeur cm 5, avec structure en métal chromé et support en polyamide, manchette souple en polyuréthane.

2D höhenverstellbare Armlehnen cm 6, mit Tiefenverstellung cm 5, verchromte Metallstruktur und weiche Polyamid Armauflage.

XB084

Braccioli 3D regolabili in altezza cm 6, traslazione top bracciolo cm 5, larghezza cm 3+3, con struttura in metallo cromato, con top morbido in poliuretano.

3D adjustable armrests (height 6 cm, depth 5 cm, width cm 3+3) with chromed metal structure and polyamide support, with polyurethane soft pad.

Accoudoirs 3D réglables en hauteur cm 6, profondeur cm 5, largeur cm 3+3, avec structure en métal chromé et soutien en polyamide, manchette souple en polyuréthane.

3D höhenverstellbare Armlehnen cm 6, mit Tiefenverstellung cm 5, Breitenverstellung cm 3+3, verchromte Metallstruktur und weiche Polyurethan Armauflage.

**XB024**

Braccioli regolabili
4D cromati top morbido

Braccioli 4D regolabili in altezza cm 6, traslazione top bracciolo cm 4, larghezza cm 3+3 e rotazione top $\pm 20^\circ$ con struttura in metallo cromato, top morbido in poliuretano.

4D adjustable armrests (height 6 cm, depth 4 cm, width cm 3+3 and top rotation $\pm 20^\circ$) with chromed metal structure and polyamide support, with polyurethane soft pad.

Accoudoirs 4D réglables en hauteur cm 6, profondeur cm 4, largeur cm 3+3 et rotation manchette $\pm 20^\circ$, avec structure en métal chromé et soutien en polyamide, manchette souple en polyuréthane.

4D höhenverstellbare Armlehnen cm 6, mit Tiefenverstellung cm 5, Breitenverstellung cm 3+3, Drehbar $\pm 20^\circ$, verchromte Metallstruktur und weiche Polyurethan Armauflage.

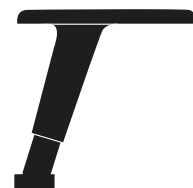
**XB020 / XB021**

Braccioli regolabili
2D / 3D poliamide

XB020

Braccioli 2D regolabili in altezza cm 8, traslazione top bracciolo cm 5, con struttura in poliamide rinforzata fibra vetro e top in poliamide.

2D adjustable armrests (height 8 cm, depth 5 cm), with fiberglass reinforced polyamide structure and polyamide support.

Accoudoirs 2D réglables en hauteur cm 8 et profondeur cm 5, avec structure en polyamide renforcée en fibre de verre et support en polyamide.

2D höhenverstellbare Armlehnen cm 8, mit Tiefenverstellung cm 5, glasfaserverstärkte Polyamid Struktur und Polyamid Armauflage.

XB021

Braccioli 3D regolabili in altezza cm 8, traslazione top bracciolo cm 5, larghezza cm 2,5+2,5, con struttura in poliamide rinforzata fibra vetro e top in poliamide.

3D adjustable armrests (height 8 cm, depth 5 cm, width cm 2,5+2,5) with fiberglass reinforced polyamide structure and polyamide support.

Accoudoirs 3D réglables en hauteur cm 8, profondeur cm 5, largeur cm 2,5+2,5, avec structure en polyamide renforcée en fibre de verre et soutien en polyamide.

3D höhenverstellbare Armlehnen cm 8, mit Tiefenverstellung cm 5, Breitenverstellung cm 2,5+2,5 mit glasfaserverstärkte Polyamid Struktur und Polyamid Armauflage.

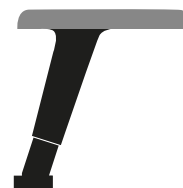
**XB022 / XB023**

Braccioli regolabili
2D / 3D poliamide
top morbido

XB022

Braccioli 2D regolabili in altezza cm 8, traslazione top bracciolo cm 5, con struttura in poliamide rinforzata fibra di vetro, top morbido in poliuretano.

2D adjustable armrests (height 8 cm, depth 5 cm), with fiberglass reinforced polyamide structure and polyamide support, with soft pad.

Accoudoirs 2D réglables en hauteur cm 8 et profondeur cm 5, avec structure en polyamide renforcée en fibre de verre et soutien en polyamide, manchette souple en polyuréthane.

2D höhenverstellbare Armlehnen cm 8, mit Tiefenverstellung cm 5, glasfaserverstärkte Polyamid Struktur und weiche Polyamid Armauflage.

XB023

Braccioli 3D regolabili in altezza cm 8, traslazione top bracciolo cm 5, larghezza cm 2,5+2,5, con struttura in poliamide rinforzata fibra vetro e top morbido in poliuretano.

3D adjustable armrests (height 8 cm, depth 5 cm, width cm 2,5+2,5) with fiberglass reinforced polyamide structure and polyamide support, with polyurethane soft pad.

Accoudoirs 3D réglables en hauteur cm 8, profondeur cm 5, largeur cm 2,5+2,5, avec structure en polyamide renforcée en fibre de verre et soutien en polyamide, manchette souple en polyuréthane.

3D höhenverstellbare Armlehnen cm 8, mit Tiefenverstellung cm 5, Breitenverstellung cm 2,5+2,5 mit glasfaserverstärkte Polyamid Struktur und weiche Polyamid Armauflage.

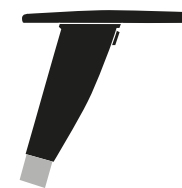
**XB018 / XB082**

Braccioli regolabili
2D / 3D cromati
top poliamide

XB018

Braccioli 2D regolabili in altezza cm 8, traslazione top bracciolo cm 5, con struttura in metallo cromato e top in poliamide.

2D adjustable armrests (height 6 cm, depth 5 cm) with chromed metal structure and polyamide support.

Accoudoirs 2D réglables en hauteur cm 6 et profondeur cm 5, avec structure en métal chromé et support en polyamide.

2D höhenverstellbare Armlehnen cm 6, mit Tiefenverstellung cm 5, verchromte Metallstruktur und Polyamid Armauflage.

XB082

Braccioli 3D regolabili in altezza cm 6, traslazione top bracciolo cm 5, larghezza cm 3+3, con struttura in metallo cromato, con top poliamide.

3D adjustable armrests (height 6 cm, depth 5 cm, width cm 3+3) with chromed metal structure and polyamide support, with polyamide pad.

Accoudoirs 3D réglables en hauteur cm 6, profondeur cm 5, largeur cm 3+3, avec structure en métal chromé et soutien en polyamide, manchette en polyamide.

3D höhenverstellbare Armlehnen cm 6, mit Tiefenverstellung cm 5, Breitenverstellung cm 3+3, verchromte Metallstruktur und Polyurethan Armauflage.

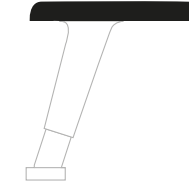
**XB077 / XB078**

Braccioli regolabili
2D / 3D poliamide

XB077

Braccioli 2D regolabili in altezza cm 8, traslazione top bracciolo cm 5, con struttura in poliamide rinforzata fibra vetro e top in poliamide.

2D adjustable armrests (height 8 cm, depth 5 cm), with fiberglass reinforced polyamide structure and polyamide support.

Accoudoirs 2D réglables en hauteur cm 8 et profondeur cm 5, avec structure en polyamide renforcée en fibre de verre et soutien en polyamide.

2D höhenverstellbare Armlehnen cm 8, mit Tiefenverstellung cm 5, glasfaserverstärkte Polyamid Struktur und Polyamid Armauflage.

XB078

Braccioli 3D regolabili in altezza cm 8, traslazione top bracciolo cm 5, larghezza cm 2,5+2,5, con struttura in poliamide rinforzata fibra vetro e top in poliamide.

3D adjustable armrests (height 8 cm, depth 5 cm, width cm 2,5+2,5) with fiberglass reinforced polyamide structure and polyamide support.

Accoudoirs 3D réglables en hauteur cm 8, profondeur cm 5, largeur cm 2,5+2,5, avec structure en polyamide renforcée en fibre de verre et soutien en polyamide.

3D höhenverstellbare Armlehnen cm 8, mit Tiefenverstellung cm 5, Breitenverstellung cm 2,5+2,5 mit glasfaserverstärkte Polyamid Struktur und Polyamid Armauflage.

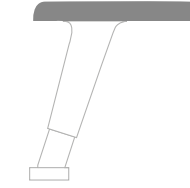
**XB079 / XB080**

Braccioli regolabili
2D / 3D poliamide
top morbido

XB079

Braccioli 2D regolabili in altezza cm 8, traslazione top bracciolo cm 5, con struttura in poliamide rinforzata fibra di vetro, top morbido in poliuretano.

2D adjustable armrests (height 8 cm, depth 5 cm), with fiberglass reinforced polyamide structure and polyamide support, with soft pad.

Accoudoirs 2D réglables en hauteur cm 8 et profondeur cm 5, avec structure en polyamide renforcée en fibre de verre et soutien en polyamide, manchette souple en polyuréthane.

2D höhenverstellbare Armlehnen cm 8, mit Tiefenverstellung cm 5, glasfaserverstärkte Polyamid Struktur und weiche Polyamid Armauflage.

XB080

Braccioli 3D regolabili in altezza cm 8, traslazione top bracciolo cm 5, larghezza cm 2,5+2,5, con struttura in poliamide rinforzata fibra vetro e top morbido in poliuretano.

3D adjustable armrests (height 8 cm, depth 5 cm, width cm 2,5+2,5) with fiberglass reinforced polyamide structure and polyamide support, with polyurethane soft pad.

Accoudoirs 3D réglables en hauteur cm 8, profondeur cm 5, largeur cm 2,5+2,5, avec structure en polyamide renforcée en fibre de verre et soutien en polyamide, manchette souple en polyuréthane.

3D höhenverstellbare Armlehnen cm 8, mit Tiefenverstellung cm 5, Breitenverstellung cm 2,5+2,5 mit glasfaserverstärkte Polyamid Struktur und weiche Polyamid Armauflage.

Certifications



Certification and guarantee
of absolute product quality

CATAS MEMBER

L'azienda ha instaurato un rapporto continuativo di collaborazione con l'ente di certificazione CATAS alla quale si affida per le prove di laboratorio sui propri prodotti.

The company has an established and constant relationship and cooperation with the CATAS certification institute, whom it relies upon for the tests on its own products.

La société a établi une relation de collaboration durable avec l'organisme de certification CATAS auquel elle se rapporte pour les tests de laboratoire des produits.

Die Firma hat eine dauerhafte Zusammenarbeit mit der Zertifizierungsinstitut CATAS etabliert, auf dem sie vertraut für Laboruntersuchungen von ihren Produkten.



IQNet Certified
Management System

IQNet CERTIFIED

IQNet è l'ente di valutazione del sistema di gestione che per essere certificato deve rispettare i requisiti degli standard ISO 9001, ISO 14001, OHSAS 18001.

IQNet is the organization that certifies the management system according to the requirements of ISO 9001, ISO 14001, OHSAS 18001.

IQNet est l'organisme d'évaluation du système de gestion que pour obtenir le certifié doit respecter les caractéristiques des standards ISO 9001, ISO 14001, OHSAS 18001 (Certification IQNet Management System)

IQNet ist ein Amt, der das Managementsystem würdigt. Um bescheinigt zu werden, muss das Managementsystem die folgenden Standardsvoraussetzungen erfüllen: ISO 9001, ISO 14001, OHSAS 18001 (Zertifizierung: IQNet Management System).



ISO 9001:2008
Quality

ISO 9001

L'azienda ha adottato e mantiene un sistema di gestione della qualità certificato secondo la norma.

The company adopted and maintains a quality management system certified in compliance with the ISO 9001 regulation.

Notre société a adopté et garde un système de management de qualité certifié selon la norme ISO 9001.

Unsere Firma hat ein Qualitätsmanagementsystem eingeführt und gehalten, in Übereinstimmung mit der Norm ISO 9001.



OHSAS 18001:2007
Safety

OHSAS 18001

L'azienda ha adottato e mantiene un sistema di gestione della salute e sicurezza sul lavoro certificato secondo la norma.

The company adopted and maintains a health and working environment safety management system in compliance with the OHSAS 18001 regulation.

Notre société a adopté et garde un système de management de la santé et de la sécurité du travail selon la norme OHSAS 18001.

Unsere Firma hat ein Managementsystem für Gesundheit und Sicherheit am Arbeitsplatz eingeführt und gehalten, in Übereinstimmung mit der Norm OHSAS 18001.



ISO 14001:2004
Environmental

ISO 14001

L'azienda ha adottato e mantiene un sistema di gestione ambientale certificato secondo la norma.

The company adopted and maintains an environment management system certified in compliance with the ISO 14001 regulation.

Notre société a adopté et garde un système de management environnemental certifié selon la norme ISO 14001.

Unsere Firma hat ein Umweltsmanagementsystem eingeführt und gehalten, in Übereinstimmung mit der Norm ISO 14001.



OMOLOGAZIONE MINISTERIALE 1IM: Atto con il quale il Ministero dell'Interno decreta uno specifico modello di seduta conforme ai criteri definiti dal D.M. 26/06/1984 e successivo D.M. 03/09/2001 "Classificazione di reazione al fuoco e omologazione dei materiali ai fini della prevenzione incendi". L'omologazione è obbligatoria per l'arredo di aree pubbliche e per tutte le attività soggette alla prevenzione incendi quali sale congressi, bar, ristoranti, ospedali, hotel, mense, ecc...

MINISTERIAL HOMOLOGATION 1/M: Act by which the Ministry of Interior decrees a specific model of seat complying the criteria defined by D.M. 26/06/1984 and following D.M. 03/09/2001 "Classification of reaction to fire and approval of materials in order to prevent fires". The homologation is required for public areas' furniture and for all activities subject to fire prevention such as conference rooms, bars, restaurants, hospitals, hotels, canteens.

HOMOLOGATION 1 IM: Loi parmi de la quelle le Ministre de l'intérieur établie un modèle spécifique de siège conforme aux critères indiqués par le Décret Ministériel 26/06/84 et suivant Décret Ministériel 03/09/2001. « Classification de réaction au feu et homologation des matériaux pour la prévention des incendies ». L'homologation est obligatoire pour l'ameublement des ambians publics et pour tout activité objet de prévention des incendies comme salles de congrès, bars, restaurants, hôpitaux, hôtels, salles à manger, etc.

HOMOLOGATION 1/M: Gesetz, mit dem Ministerium des Innern ein bestimmtes Modell des Sitzes die Kriterien D.M. 26/06/1984 und folgendes D.M.03/09/2001 "Klassifizierung des Brandverhaltens und Zulassung von Materialien um Brände zu verhindern" verordnet. Die Homolgation ist erforderlich für die Einrichtung der öffentlichen Bereiche und alle Tätigkeiten für Brandverhütung wie Konferenzräume, Bars, Restauranten, Krankenhäuser; Hotels, Kantinen, u.s.w..

EN 1335

EN 1335 1-2-3: La norma definisce i requisiti dimensionali, di sicurezza e prestazionali richiesti per le "sedie da lavoro per ufficio", nonché i relativi metodi di prova. I requisiti presenti nella norma si basano sull'utilizzo della seduta per 8 ore al giorno da parte di persone fino a 110 kg.

EN 1335 1-2-3: The norm defines the dimensional, safety and performance requirements required for "office chairs" as well as the associated test methods. The requirements in the norm are based on the use of the seat for 8 hours a day by person up to 110 kg.

EN 1335 1-2-3: La norme établie les exigences dimensionnelles, de sécurité et de performance demandés pour le « sièges de travail de bureau », ainsi que les procédés de test. Les exigences indiqués dans la norme se réfèrent à l'utilisation du siège pour 8 heures par jour par des personnes jusqu'à 110 kg.

EN 1335 1-2-3: Die Norm bestimmt die Sicherheits- Dimensionen- und sonstigen Befähigungsnachweise, die für "Bürodrehstuhl" gefragt sind und die Prüfverfahren. Die Anforderungen der Norm berichten auf eine Verwendung des Stuhl acht Stunden tagsüberfür Personen bis zu 110 Kg. Gewicht.

EN 1728

EN 1728: La norma specifica i metodi di prova per la determinazione della resistenza e della durabilità della struttura di tutti i tipi di sedute.

EN 1728: The norm defines the test methods determining the resistance and durability of every type of chair.

EN 1728: La norme indique les procédés de test pour la détermination de la résistance et de la durabilité de la structure de tout typologie de sièges.

EN 1728: Die Norm bestimmt die Prüfverfahren der Festigkeit- und der Dauerhaftigkeit- der Struktur für alle Sitzmodelle.

UNI 9084

UNI 9084: La norma determina la prova di durata del meccanismo per la regolazione in altezza del sedile.

UNI 9084: The norm determines the durability test of the mechanism for the height adjustment of the seat.

UNI 9084: La norme indique le test de durée du mécanisme pour le réglage en hauteur de l'assise.

UNI 9084: Die Norm bestimmt die Prüfung der Mechanikhaltbarkeit der Sitzhöhenverstellung.

UNI 8591

UNI 8591: La norma determina la prova di durata alla rotazione del sedile.

UNI 8591 : The norm defines the durability test to the rotation of the seat.

UNI 8591: La norme indique le test de durée à la rotation de l'assise.

UNI 8591 : Die Norm bestimmt die Dauerhaltbarkeitsprüfung zu der Drehung des Sitzes.



UNI EN 9175 Classe 11M : La norma definisce i criteri ed i metodi per la classificazione di reazione al fuoco di mobili imbottiti sottoposti a piccola fiamma. I materiali imbottiti sono suddivisi nelle classi da 11M a 31M; classe 11M è la più severa.

UNI EN 9175 Classe 11M: The regulation defines the criteria and classification methods of upholstered furniture subject to small flame. The upholstered materials are divided into 3 classes from 11M to 31M; Class 11M is the strictest.

UNI EN 9175 Classe 11M : La norme établie les critères et les méthodes pour la classification de réaction au feu de meubles rembourrés soumis à petite flamme. Les matériaux rembourrés sont divisés en classement de 11M à 31M ; le classement 11M est le plus sévère.

UNI EN 9175 Classe 11M : Die Norm definiert die Kriterien und Methoden für die Klassifizierung des Brandverhaltens von Poltstermöbeln kleiner Flamme ausgesetzt. Die gepolsterten Materialien in Klassen von 11M bis 31M eingestuft sind; Klasse 11M ist die strengste.

EN ISO 9241

EN ISO 9241: Parte 5: (1998) Questa norma specifica i requisiti ergonomici per un posto di lavoro con utenti videoterminalisti, ai quali permetterà di adottare una postura comoda ed efficiente.

EN ISO 9241: Part 5: (1998) Workstation layout and postural requirements This part specifies the ergonomics requirements for a Visual Display Terminal workplace which will allow the user to adopt a comfortable and efficient posture.

EN ISO 9241: Part 5: (1998) Cette norme indique les réquisits ergonomiques d'un poste de travail pour utilisateurs équipés d'écran, afin d'adopter une posture confortable et efficiente.

EN ISO 9241: Die Norm bestimmt die Anforderungen an die Arbeitsplatzgestaltung insbesondere Sichtgerätsbenutzer, für welche eine komfortable und gesunde Haltung haben werden.

UNI EN 12720

UNI EN 12720: La presente norma europea specifica un metodo per la valutazione della resistenza ai liquidi freddi di tutte le superfici mobili rigide. Essa non si applica alle superfici in pelle e tessuto.

UNI EN 12720: This European standard specifies a method for the assessment of the resistance to cold liquids of all rigid furniture surfaces regardless of materials. It does not apply to leather and textile surfaces.

UNI EN 12720: Cette norme européenne indique le procédé d'évaluation de la résistance aux liquides froids de toute surface rigides de meubles, quoi que se soit le matériau. La norme ne s'applique pas aux surfaces en cuir ou tissu.

UNI EN 12720: Die europäische Norm bestimmt die Prüfverfahren der Festigkeit des harten Oberfläches gegen kalte Flüssigkeit, ausser Leder- und Stoffoberfläche.



L'OEKO-TEX® Standard 100 è un sistema di controllo e certificazione indipendente per tutto il mondo tessile dalle materie prime, ai semilavorati e ai prodotti finiti in tutte le fasi di lavorazione.

OEKO-TEX® Standard 100 is a worldwide textile control and certification system for raw materials, semi-finished products and finished products at all stages of processing.

L'OEKO-TEX® Standard 100 est un système de contrôle et de certification indépendant pour les produits textiles bruts, intermédiaires et finis à toutes les étapes de traitement.

Der OEKO-TEX® Standard 100 ist ein unabhängiges Prüf- und Zertifizierungssystem für textile Roh-, Zwischen- und Endprodukte aller Verarbeitungsstufen.

D.Lgs 81

D. Lgs 81: La seduta è conforme a quanto prescritto dal Testo Unico sulla sicurezza sul lavoro: rispondenza alla norma 1335 nella parte 1-2-3; regolazione in altezza del sedile e dello schienale e del supporto lombare; inclinazione dello schienale; rispondenza almeno alla Tip. B della EN 1335-1.

D. Lgs 81 : The chair complies with the requirements indicated by the Consolidated Law on safety at work: compliance with the norm 1335 in the parts 1-2-3; height adjustment of the seat, the backrest and lumbar support; inclination of backrest; compliance at least with Type B of EN 1335-1.

D. Lgs 81: Le siège est en conformité avec les dispositions du « Testo Unico » pour la sécurité du travail : correspondance à la norme 1335 parts 1-2-3 ; réglage en hauteur de l'assise et du dossier et du soutien lombaire ; inclinaison du dossier ; correspondance au moins à la typologie B.

D. Lgs 81 : Der Sitz erfüllt die Voraussetzungen, die dieser Gesetzesdekret über Sicherheit am Arbeitsplatz benötigt: Einhaltung der Norm 1335 im 1-2-3 Teil; Höhenverstellung der Sitz und Rückenlehne und Lumbalstütze; Neigung der Ruckenlehne; Einhaltung zumindest den Typ B von EN 1335-1.

EN 16139

EN 16139: La norma specifica i requisiti per la sicurezza, la resistenza e la durata per tutti i tipi di sedute non domestiche per adulti, incluse le "sedie per visitatori".

EN 16139: The norm defines the safety, resistance and durability requirements of every type of non-domestic chair, also for the visitor chair.

EN 16139: La norme indique les caractéristiques de sécurité, résistance et durabilité de tout typologie de sièges non domestiques pour adultes y incluses les chaises visiteurs.

EN 16139: Die Norm spezifiziert die Sicherheit-, Widerstand- und Dauerhaftigkeitsvoraussetzung für Arbeitsstühle, ausser die Hausgebrauchte Stühle, und Besucherstühle.

UNI 9083

UNI 9083: La norma stabilisce un metodo per la verifica della resistenza alla caduta delle sedie e degli sgabelli.

UNI 9083: The norm defines the method for testing the resistance to the fall of chairs and stools.

UNI 9083: La norme établie la procédure pour la vérification de la résistance à la chute des sièges et des tabourets.

UNI 9083: Die Norm legt eine Methode zur Prüfung des Widerstandes zum Fall der Stühle und Hocker.

EN 12727

EN 12727: La norma specifica i requisiti ed i metodi di prova che determinano la resistenza e la durata strutturale di tutti i tipi di seduta su barra che sono fissate al pavimento e/o a pareti in modo permanente, sia sotto forma di panchine che di sedie singole.

EN 12727: The norm defines the requirements and test methods determining the resistance and structural durability of beam seat fixed permanently on the floor and/or wall either in the form of benches or single seats.

EN 12727: La norme indique les caractéristiques et les procédés de test qui déterminent la résistance et la durabilité structurelle de tout typologie de sièges sur poutre fixés au sol et/ou au mur en permanence, soit en forme de banquettes soit en forme de simples sièges.

EN 12727: Die Bank-stühle und die einzelnen Stühlen, die am Fussboden und/ oder am Wände dauernnd fixiert sind, respektieren die Anforderungen und die Prüfmethoden über Widerstandsfähigkeit und Festigkeit der Struktur aller Typen von Sitzreihen der Norm.

EN 1022

UNI EN 1022: La norma specifica i metodi per determinare la stabilità di ogni tipo di seduta per adulti.

UNI EN 1022: The norm specifies the methods to determine the stability test of every type of chair for adults.

UNI EN 1022: La norme indique les procédés pour déterminer la stabilité de tout typologie de sièges pour adultes.

UNI EN 1022: Die Norm bestimmt die Prüfverfahren der Standfestigkeit für jede Stuhlmodell für Erwachsene. Die Standfestigkeit ist nach Versuchsmethode oder mit Kalkulation bestimmt.



TIP. A: Le sedie sono catalogate in 3 diverse tipologie (A, B, C) in base a specifiche caratteristiche dimensionali. La Tip. A prevede i requisiti dimensionali più restrittivi, rispetta maggiormente le dimensioni antropometriche dal 5% al 95% della popolazione.

TIP. A: Chairs are catalogued into 3 different types (A,B,C) accordingly to specific dimensional features. Type A has the strictest dimensional requirements and it is the type that respects the most the anthropometric dimension from 5% up to 95% of the population.

TIP. A: Les sièges sont énumérés en 3 différentes typologies (A, B, C) en fonction de caractéristiques dimensionnelles spécifiques. La typologie A observe les caractéristiques les plus exigeantes en respectant principalement les dimensions anthropométriques du 5% au 95% de la population.

TIP. A: Die Stühle sind in drei verschiedenen Typen (A, B, C) gemäss spezifischen Abmessungseigenschaften katalogisiert. Der Typ A erfüllt die strengsten Anforderungen an die Grosse und respektiert die anthropometrischen Massen von 5% bis 95% der Bevölkerung.

TIP. B

TIP. B: La tip. B prevede i requisiti intermedi tra le classi, rispettando i requisiti minimi richiesti dal D.Lgs. 626.

TIP. B: The B-type covers the intermediate requirements among the classes and meets the requirements of the D.Lgs. 626.

TIP. B: la typologie B prévoit les réquisits inter-moyens entre les classes, en respectant les réquisits minimaux exigés par le Décret Lgs 626.

TIP. B: Der B-Art umfasst die mittleren Anforderungen unter den klassen und erfuehlt die Voraussetzungen aus dem D.Lgs. 626.

5 YEAR WARRANTY

Garanzia produttore MOVING 5 anni.

MOVING Manufacturer warranty 5 years.

Garantie fabricant MOVING 5 ans.

Garantie der Hersteller 5 Jahre.

ERGOCERT

ERGOCERT: Ente di certificazione per l'ergonomia, ha premiato Crono con il Premio ComfortSeating2011. Nella sezione Ufficio, la seduta ha raggiunto i migliori risultati in termini di comfort di seduta ottenendo il riconoscimento come Miglior Prodotto per Qualità ergonomica/prezzo.

ERGOCERT: is an institute for the certification of ergonomics and has awarded CRONO chair "ComfortSeating 2011". In the section "office", the chair has achieved the best results regarding seat comfort and has been recognized as the best product for quality in ergonomics and price.

ERGOCERT: organisme de certification pour l'ergonomie, a récompensé le modèle CRONO du prix Comfort Seating 2011. Dans la section bureau, le siège a atteint les résultats les meilleurs en terme de confort en obtenant la reconnaissance comme Les Meilleur Produit pour Qualité ergonomique / prix.

ERGOCERT: ist ein Institut zur Zertifizierung der Ergonomie und hat CRONO Stuhl mit Preis „ComfortSeating 2011“ ausgezeichnet. Im Abschnitt „Büro“, hat der Stuhl die besten Ergebnisse in Bezug Sitzconfort erreicht und wurde als beste Produkt für Qualität in Ergonomie und Preis erkannt.

eco

Brevetto depositato per collezione Ecochair.

Registered Patent of the ECOCHAIR collection.

Brevet enregistré pour la collection ECOCHAIR.

Registriertes Patent für die Kollektion ECOCHAIR.



TÜV Rheinland Group: Un prodotto certificato TÜV è un prodotto garantito sotto il profilo della qualità e della sicurezza da un ente di assoluta professionalità e riconosciuto a livello mondiale.

TÜV Rheinland Group: A product certified by TÜV is guaranteed in terms of quality and safety by an organization of absolute professionalism and worldwide recognized.

Tüv Rheinland Group: Un produit certifié Tüv est un produit garanti en terme de qualité et de sécurité par un organisme absolument professionnel, reconnu à niveau mondiale.

TÜV Rheinland Group: Ein TUV-bescheinigter Produkt ist von einem hochprofessionellen und Weltberühmten Amt fuer Qualitatet und Sicherheit gewährleistet.

Warranty

La garanzia ha validità di 5 anni dalla data di consegna. Resta inteso che sono esclusi dalla garanzia i componenti normalmente soggetti all'usura generale. La garanzia comprende i soli difetti di fabbricazione o dei materiali, quindi non copre i danni causati da un cattivo uso del prodotto o da un uso improprio (sovraccarichi sui componenti, urti o strappi) oppure eccessivo (ai fini della garanzia si presume un utilizzo normale del prodotto, quantificabile in una media di 8 ore giornaliere).

L'accertamento di un eventuale difetto di fabbricazione o dei materiali potrà essere realizzato solo dalla venditrice o dal responsabile commerciale o di area, tramite sopralluoghi o con il rientro in azienda dei componenti difettosi, o ancora previo spedizione da parte del cliente di esauriente documentazione fotografica.

Durante i primi 6 mesi di garanzia, tutti i componenti con difetti di fabbricazione accertati e riconosciuti dalla venditrice saranno sostituiti gratuitamente, così come gratuite saranno le altre spese sostenute dalla venditrice per il ripristino del prodotto. Dal 7° al 24° mese di garanzia vale quanto detto al capoverso precedente con la differenza che il trasporto sarà a carico del cliente. Dal 25° al 60° mese di garanzia solamente le parti di ricambio saranno gratuite, mentre manodopera, trasporto e montaggio saranno a carico del cliente.

Le riparazioni in garanzia potranno essere eseguite dalla venditrice dopo aver ricevuto presso la propria sede il pezzo da sostituire o, se il caso lo richiede, l'intera seduta oggetto del difetto protetta da adeguato imballo. Se a controllo effettuato la venditrice riscontrerà che il difetto è stato causato da uso cattivo, improprio o eccessivo da parte dell'acquirente, provvederà ad addebitare a quest'ultimo tutti i costi relativi, compreso il trasporto.

The warranty has a 5 year validity from delivery date. The warranty does not cover the components usually subject to general wear. The warranty covers only production flaws or defects of the materials and therefore does not cover damages resulting from a wrong use of the product or from an improper use (overloading of the components, bumps or tears) or excessive use (for the warranty to be valid a normal use of the product of 8 daily hours is assumed).

Verification of eventual production flaws or defects of the materials will be executed only by the seller or by the sales or area manager, through surveys on location or upon receipt of the flawed components at the company's premises, or upon receipt of thorough photographic documentation from the customer.

During the first six months of warranty, all defected parts with production flaws assessed and acknowledged by the seller, will be replaced free of charges, as well as free of charge will be all the additional costs incurred by the seller for the restoration of the product. From the 7th to the 24th month after delivery, warranty is as above with the only difference of the shipping costs, that will be on the customer's account. From the 25th to the 60th month of warranty, spare parts only are free of charge, whereas labour, transport and assembly costs are on the customer's account.

All repairs covered by the warranty will be executed from the seller upon receipt of the flawed parts at the seller's premises or, if required, upon receipt of the whole damaged chair adequately packaged. If after the assessment of the damage, the seller will verify that the defect resulted from wrong, improper or excessive use by the buyer, all the related costs, transport included, will be charged to the latter.

La garantie a validité de 5 ans à partir de la date de livraison. Il reste entendu que les composants normalement sujets à usure générale sont exclus de la garantie. La garantie concerne les seuls défauts de fabrication ou des matériels, donc elle ne couvre pas les dommages causés par un mauvais usage du produit ou par un usage improprie (surchargés sur les composants, chocs ou éraillures) ou bien excessif (aux fins de la garantie on présume un usage normal du produit en considérant une moyenne de 8 heures par jour).

La vérification d'éventuels défauts de fabrication ou des matériels pourra être effectuée uniquement par le vendeur ou par le responsable commercial de zone, par des descentes ou en rentrant à entreprise les composants défectueux, ou encore parmi de l'envoi de la part du client de documentation photographique complète).

Pendant les premiers 6 mois de garantie, tous les composants avec des défauts de fabrication vérifiés et reconnus par le vendeur seront remplacés gratuitement, ainsi que seront gratuites les autres frais soutenues par le vendeur pour le remis en état du produit. Du 7ème au 24ème mois de garantie il vaut ce que on a écrit dans l'alinéa précédent avec la différence que le transport sera à la charge du client. Du 25ème au 60ème mois de garantie seront gratuites seulement les pièces de rechange, tandis que la main d'oeuvre, le transport, et l'assemblage seront à la charge du client.

Les réparations en garantie pourront être effectuées par le vendeur après avoir reçu chez lui le composant à remplacer ou, si le cas le demande, le siège complet objet du défaut, protégé par un emballage adéquat. Si après le control, le vendeur relèvera que le défaut a été causé par une mauvaise ou improprie ou excessive utilisation de la part de l'acheteur, il agira en débitant à ce dernier tous les frais relatives, transport compris.

Die Garantie ist gültig 5 Jahren ab Lieferdatum. Vorausgesetzt dass die Verschleißteile von der Garantie ausgeschlossen sind. Die Garantie versteht sich nur für Fabrikations- oder Materialsfehler und deckt deswegen keine Schaden für schlechte oder unpassende (Überladung der Bestandteile, Stöße oder Reißen) sowie übertriebene Benutzung (eine normale Benutzung des Produkts entspricht durchschnittlich 8 Stunden pro Tag).

Die Feststellung von Fabrikations- oder Materialsfehlern kann nur vom Verkäufer oder vom verantwortlichen Kaufmann ausgeführt werden, durch Zusendung der fehlerhaften Komponenten oder auch ausreichenden Fotomaterials vom Kunden.

Während der ersten 6 Garantiemonate, werden alle Bestandteile mit Fabrikationsfehlern, die vom Verkäufer festgestellt wurden, kostenlos ersetzt; so werden auch die Kosten für die Wiederherstellung des Produkts kostenlos sein. Vom 7. bis zum 24. Garantiemonat gilt das Obengesagte, mit dem Unterschied, dass die Frachtkosten vom Kunden übernommen werden. Vom 25. bis zum 60. Garantiemonat werden nur die Ersatzteile kostenlos sein; dagegen werden Arbeitskraft, Fracht und Montage vom Kunden übernommen.

Die Reparatur in Garantie kann nach Eingang des Teiles oder des Stuhles, entsprechend verpackt, in unserer Firma vom Verkäufer erledigt werden. Sollte der Verkäufer nach der Prüfung feststellen, dass die Schaden durch schlechte, unpassende oder übertriebene Benutzung (seiten des Käufers) verursacht wurde, wird er den Kunden mit den relativen Kosten, einschließlich Fracht, belasten.

Moving, al fine di migliorare le caratteristiche tecniche e qualitative della sua produzione, si riserva il diritto di modificare in tutto o in parte il contenuto del presente catalogo anche senza preavviso.

Tutte le misure sono da considerarsi approssimative.

Il peso indicato non include le opzioni della seduta.

Moving, to improve the technical and qualitative characteristics of production, reserves the right to modify entirely or partially the content of the present catalogue even without notice.

All dimensions must be considered as an approximate.

The Weight stated do not include the chair options.

Moving, au fin de améliorer les caractéristiques techniques et qualitatives de son produit, se réserve le droit de modifier le contenu en tout ou en parte de ce catalogue aussie sans préavis.

Toute dimension est indicative.

Le poids indiqué ne comprend pas les options de la siège.

Moving, am Ende der Verbesserung von den technischen und qualitativen Kennzeichens der Produktionen, behalte sich das Recht vor um den Inhalt des vorhandenen Katalog, ohne Ankuendigung, ausschliesslich oder teilweise zu aendern.

Alle Abmessungen sind indikativ zu berücksichtigen.

Das angegebene Gewicht entspricht ohne den Optionen.

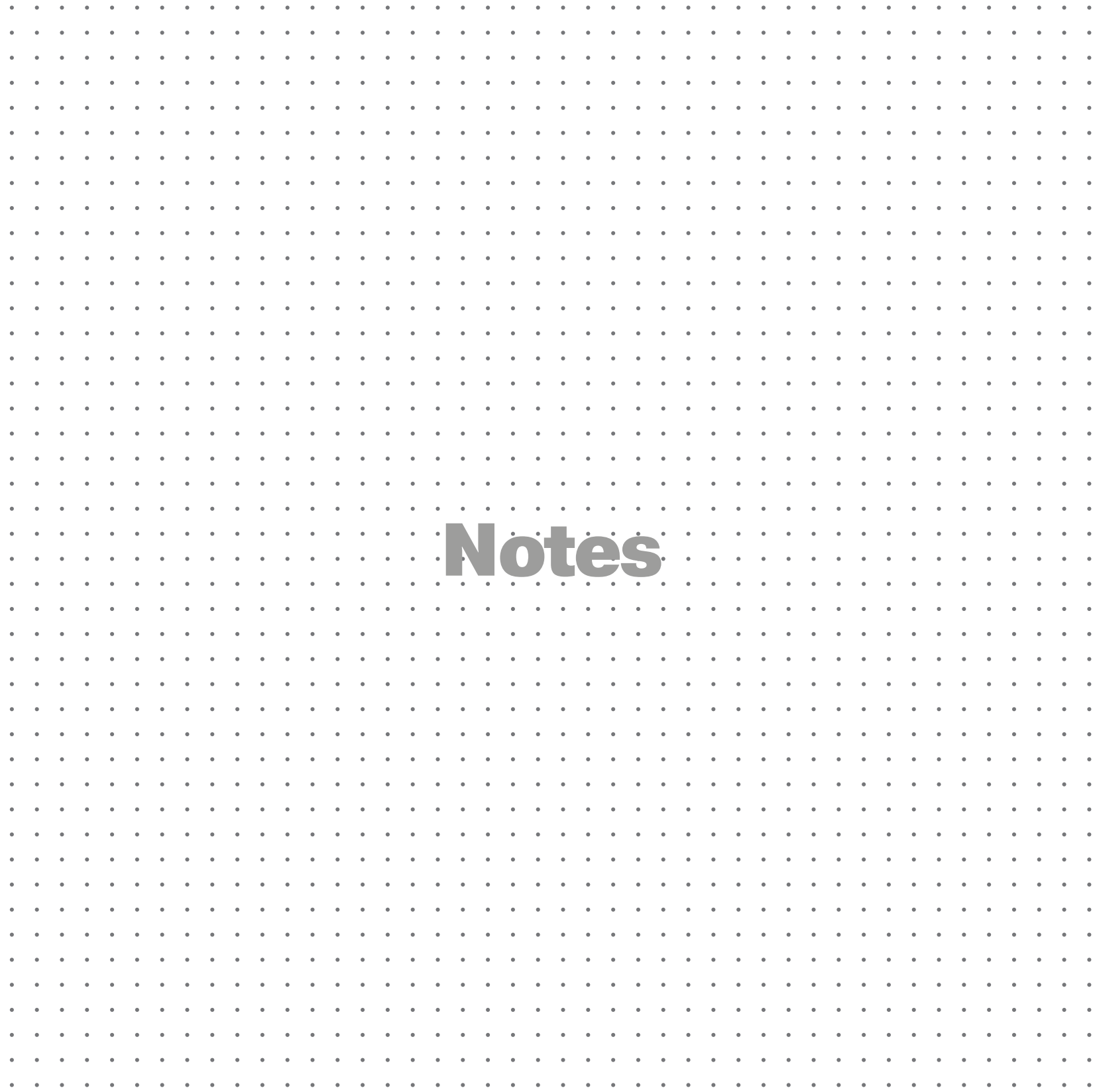
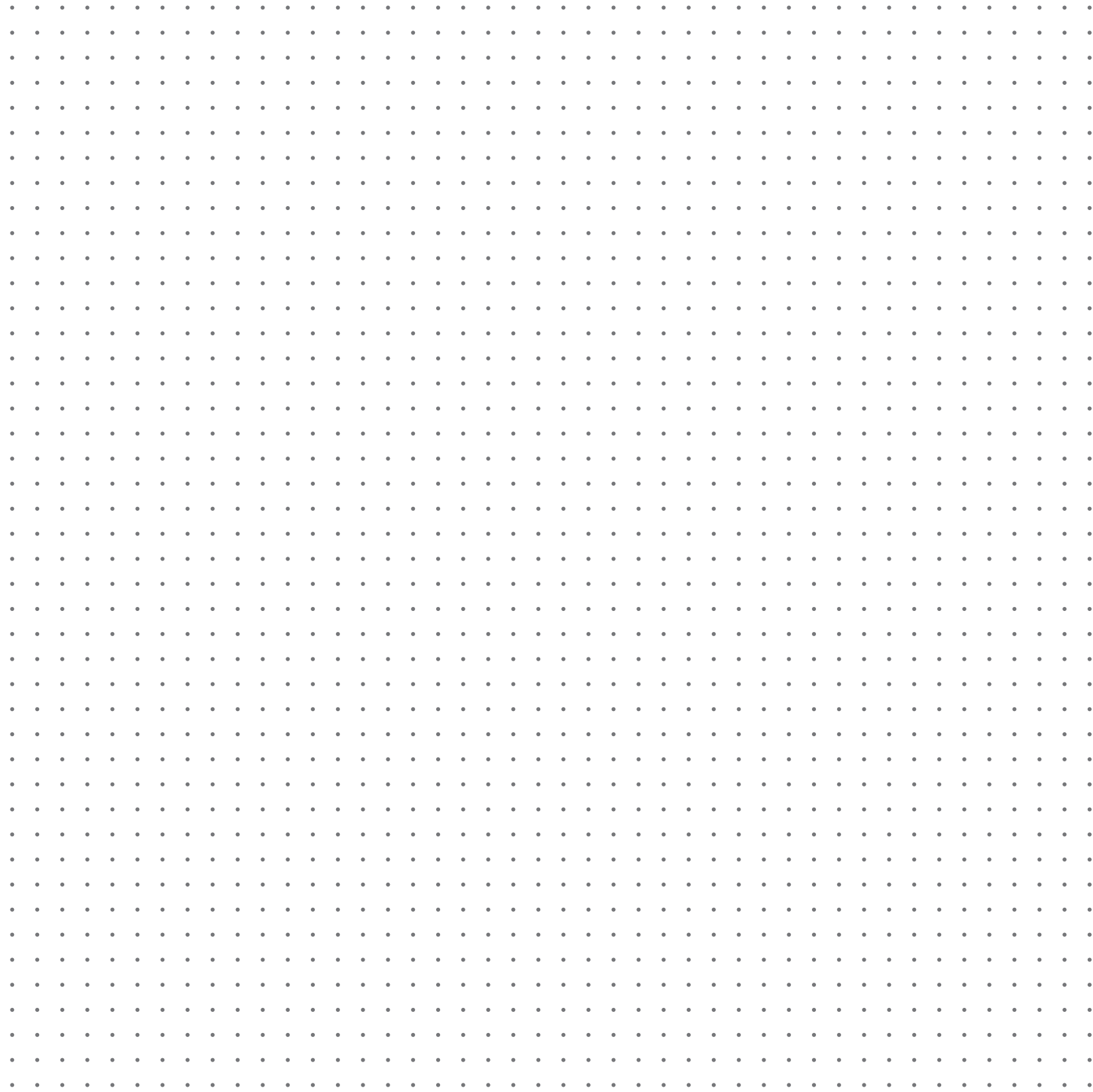

Notes

Contacts

MOVING srl
Via dell'Artigianato 1
Trissino (VI) Italy

T +39 0445 490777
F +39 0445 490008
info@moving.vi.it

moving.vi.it



© all rights reserved MOVING srl 2017
Made in Italy December 2017

Any reproduction of this document, even partial,
is prohibited without the prior authorisation
of the company MOVING srl.

Photographic techniques do not allow perfect
reproduction of color shades, which should therefore
be considered as purely indicative
Printed colors on leather or fabrics may vary.

Concept CATIA MASSARO
Photos RICCARDO URNATO FOTOGRAFO
Print ESPERIA

 **MOVING**
CHAIRS COLLECTIONS

moving.vi.it



MOVING
CHAIRS COLLECTIONS