

infiniti

DESIGNED  
TO BE  
SOCIAL

# INDEX

## POST-CONSUMER RECYCLING PRODUCTS

- CANOVA PCR 14
- TONDINA PCR 18
- PURE LOOP PCR 22

## NEW PRODUCTS

- SICLA 26
- EASTWOOD 40
- FELUCA 46
- EKKI 52
- BOMBOM 60
- FLINK TABLE 68
- DIAPASON 72

## RANGE EXTENSIONS

- 80 RELIEF
- 98 HARMO
- 106 RUELLE
- 114 TONDINA POP
- 124 COOKIE
- 128 UTI
- 134 KRAM
- 140 PEB
- 148 KLEJN
- 162 FLINK
- 168 RECORD BENCH
- 176 RECORD LIVING
- 186 RECORD MEETING

## FINISHES

- 192 FINISHES

## HOW TO READ THE PRICELIST

This price list contains a series of technical information and use suggestions for those who intend to purchase or already have bought items belonging to the Infiniti range. The price list divides the collections into: chairs, armchairs, stools, tables. All indications here present are shown in triple language: Italian, English and Spanish. Infiniti reserves the right to modify or ameliorate the products without any prior advice.

### HOW TO USE THE PRICE LIST

The pages of the price list contain all necessary information for a complete description of the product. In particular, for each item are displayed:

- Picture of the item;
- Name of product
- Chart with:
  - frame and seat/back or shell finishing for chairs and stools;
  - table structure and top finishing for tables;
  - prices VAT non included.
- Quantity of pieces contained in each carton box;
- All available colour finishing for seat/back or shell, frame and table top;
- Brief product description;
- Average product dimensions;
- All technical details describing unit package characteristics:
  - packaging volume;
  - quantity each carton box;
  - item weight;
  - product stacking capability;
  - certifications;
  - outdoor use capability.

Into the various colours representation it is shown the name of each colour. The same can be referred to the fabrics, leather colours and wooden finishing. Colours are purely indicative; kindly refer to the colour and finishing samples to make your choice.

### NOTE

The cost of a product with customer fabric (COM) is obtained by applying the eco leather price. The cost of a product with customer leather (COM) is obtained by increasing the eco leather price by 10%. Fabrics supplied by the customer must contain indication of front and back, and must be 140 cm wide. C.O.M. fabrics must arrive here at OMP with no freight - custom charges (DDP). The fabric, leather, lacquer, glass and wood sample colour shades are intended as a guide only, as they can vary from batch to batch. Infiniti declines all liability for slight colour differences. These differences may be more evident in items ordered at a later stage to complete previous orders. Infiniti reserves the right to change or technically improve the design and specifications of any of its products at any time and at its discretion without prior notice. It also reserves the right to withdraw, suspend or cease production of any product at any time and at its discretion without prior notice. The measurements given in the price list are approximate. There may be a tolerance due to the type of materials used.

## “INFINITI” MATERIALS

### METALS

Metals are an important part of our products: they are used in order to realize frames for chairs and table structures. Infiniti has made long and accurate research on materials and relative working technologies. In our factories we have reached elevated skills in steel and aluminium moulding/casting.

### STEEL

Steel is used to produce frames for chairs and stools, by using round or squared tubes as well as solid rod all in high resistance. Furthermore, thanks to advanced technologies (laser 3D cutting machine), we are able to gain more complex shapes. Our products are available with different surface finishes and high quality standard. (painting, satin finishes, chromium-plating).

### ALUMINIUM

This metal combines characteristics of lightness with an elevate resistance and natural beauty of the surfaces. Aluminium surface can be anodized, a special treatment in order to increase the resistance to corrosion making the surface more opaque. Infiniti uses this metal in 3 different methods:

- Die cast: used to produce chair legs in the following finishes: polished - chromed - satin
- Anodized aluminium tube
- Extrusion.

### PLASTIC MATERIALS

Infiniti, always interested in new technologies, heads to an innovative and updated development: for its production it uses both thermoplastic and thermosetting polymers. The plastic materials range from the polycarbonate to SAN to polypropylene, allowing the realization of a wide range of different finishes and characteristics. All the materials are recyclable in the respect of the environment.

### POLYPROPYLENE PP

Its main feature is its high resistance to heat and abrasion. Furthermore it is non-toxic, antistatic, scratches and stains resistant. It has a high resistance to atmospheric agents, so is meant for outdoor usage.

### WOOD

Infiniti works in the respect of all the national and international laws concerning the environment, this is achieved trough the mutual cooperation with partners / suppliers that support the non-government organization FSC (Forest Stewardship Council) that operate in order to ameliorate sustainability of the forests all around the world. FSC certified companies are able to guarantee that the woods used in their production processes, come from forests that are managed properly and responsibly, in conformity with environmental - social and economical standards. Infiniti uses paints and glues of low formaldehyde emission, using rationally the raw material. The wood used is selected among the best present in the market. Its particular processing allow to guarantee resistance and last through time. Being a natural material, difference in colour can occur between each lot of wood, but these differences cannot be considered a flaw but on the opposite side a guaranty of the authenticity of the wood used.

### SLICED ASH

It is an overlapping of ash-layers, that forms blocks which are later sliced perpendicularly to the direction of the various layer. The result is a surface that has a regular and homogeneous veining.

### COMBINATION OF OAK

It is an overlapping of different light smooth layers of wood of the same kind that creates the same effect concerning the veining and the colours of the most valuable woods.

### MULTI LAYERS

It is an overlapping of different sheets of sliced wood that are later glued together making a plywood.

### 3D MULTI LAYERS

It is an overlapping of different sheets of sliced wood that are later glued together making a single piece to be combined with the 3D engineered wood. This is a particular patented material meant to be bended in any complex 3 dimension shape without cracking.

### FENIX NTM®

Innovative-nanotech material, ultra matt and soft touch- conceived for interior design. With low light reflection, its surface is highly matt, anti-fingerprints and pleasantly soft touch. The exterior side of FENIX NTM is obtained with nanotechnologies and is characterised by a surface treated with acrylic resins of new generation, hardened and bound through the Electron Beam Curing process. Thanks to these characteristics, Fenix NTM regenerates itself from any surface micro-scratches thanks to its thermo-repairing quality.

### FABRICS

Infiniti uses fabrics that belong to a wide range of colours and patterns, which are all tested in order to achieve the best performance, among which resistance to abrasion and artificial light. The chair and armchair upholstery fabrics come in a wide range of bright colours. Fireproof fabric and imitation leather upholstery are also available. The Kvadrat collection, now available, offers top quality and high performance. The fabric can also be supplied by the customer.

### LEATHER

Top quality European full-grain leather is used for the Infiniti upholstery. Several are the possibilities to chose among leather of different shades. It is soft and elegant but at the same time very resistant. It is the results of long stages of working. Leather is tanned with chrome and pigmented with resins in a water solution. Several are the tests made in order to achieve the right level of softness and elasticity.

### RECYCLED FIBERGLASS (RFS)

The Recycled Fibreglass panel is made of recycled fiber-reinforced composites (fiberglass-kevlar-carbon fiber, etc) finely worked and re-aggregated a high pressure with minimum percentages of virgin adhesives. The procedure is patented and generates a double-green material, therefore recyclable again a end of life. In milling, the homogeneous density of the panel (1100 kg / m3) ensures robustness to the entire section, allowing processing three-dimensional without risk of defeat. The panel is a sustainable material certified by CSI.

Fire reactions: Class 2 according to UNI 9177.

## USAGE AND CARE

### PLASTIC MATERIALS

Cleaning advices: Plastic surfaces usually needs to be cleaned with a normal cloth and warm water, we recommend not to use dry cloths otherwise the scratch might generate an electrostatic load that capture dust. For the most persistent stains a small amount of liquid soap diluted in water may be used. We recommend to avoid strictly the use of acetone, trichloroethylene, ammonia and detergents that contains even just a small amount of those substances as they can turn bright shiny surfaces into opaque very easily. We recommend as well to avoid all types of abrasive substances, like for example powdered cleaning products, creams, score pads and rough sponges. Usage: Avoid to drain on the surfaces objects that can scratch the material. We also remind that plastic cannot cope with warm surfaces of elevate temperatures placed directly on top of the item, an example might be not to place warm pans or pots.

### PLYWOOD

Cleaning advices: Plywood surfaces usually needs to be cleaned with a normal cloth and warm water, we recommend always to dry immediately after the cleaning process. All liquids or other residue must be removed in order to avoid the absorption of the same. Usage: Being plywood a natural material you might notice an alteration in the colour shade during time and use. We also remind that plywood cannot cope with warm surfaces of elevate temperatures placed directly on top of the item, an example might be not to place warm pans or pots; doing so can change the colour of the shell.

### METALS

Cleaning advices: Plastic surfaces usually needs to be cleaned with a normal cloth and warm water, for the most persistent stains a small amount of liquid soap diluted in water may be used. We recommend always to dry immediately after the cleaning process by using a soft cloth or a leather one. Never use: cleaning products for steel ovens, chlorine, bleach, or other strong detergents. Avoid abrasive creams, score pads and abrasive sponges that can scratch the metal surfaces. Usage: Mind the stains of food such as coffee, juices, coke, if not removed immediately they might leave indelible marks on the surface.

### FABRICS

Cleaning: see care and washing advice on finishes. Usage: We remind you that fabrics are extremely delicates it is therefore very important to look carefully at the kind of wash suggested and pay particular attention while using because they are subject to be ripped or cut.

### LEATHERS

Cleaning advices: Clean with a soft cloth with warm water. Usage: We remind that leathers are extremely delicates. It is therefore very important to look carefully at the kind of wash suggested and pay particular attention while using because they are subject to be ripped or cut. Exposition in spaces with an elevate percentage of humidity might cause structural modifications.

## RECYCLABILITY

The Infiniti range is built for the majority in metal elements, plastic materials and in plywood, all materials 100% recyclable. Metal for example is one of the most

recycled materials on planet hearth and allowed a saving of about a 95% of the energy otherwise used to obtain it from the raw material. The metals received are sent to dedicated centres to be divided into irony and non irony trough magnets, floating methods, air and manually. Chemical analysis might be done to divide further the rubbish. Non irony materials, such as aluminium, are pressed together in balls and sent back to the foundries. In the foundries the metals are melted again and the production process begin from point 0, returning into raw material, ready to be used for the production of brand new products. To re-use, recycle and recover are primary targets in the UE environmental policy that rules the usage of plastics materials, every day more parts that belongs to our normal lives. Plastic had a huge and global success in the past exactly for his characteristics, in fact plastic has the possibility to be moulded in any shape or dimension, throughout different technical solutions adapted according to the product: straining, mould injection, extrusion, injection. The main point of strength of this material are: lightness, workability. Our whole world seems like enveloped in a plastic film. The production of plastic in fact take only a 1,6% on the whole European consume of Oil. The most used materials are the one named thermoplastic, which are polymers that can be worked and moulded warm to be suddenly cooled in order to obtain the wanted shape. The process is absolutely reversible to guarantee an elevate recyclability. Plastic for his multiple uses properties can be found in many of the “Infiniti” products ranges. At the end of the use plastic can be reused in three main ways: the mechanical recycling meant to transform the material into another material; the plastic waste is becoming the starting point for the new products; the chemical recycling meant to transform the waste into raw material trough the melting of the same; the last is the energetic recovery contained into the plastic waste as oil derivate and therefore completely recyclable. Furthermore is only trough the recycling process that plastic can return to a new life. To make the process easier, Infiniti products are easily unassembled so that can be quickly recognised any basic element. Any plastic item produced is marked to identify the material used, according to the European legislations to guarantee the proper separation of the elements and their real and effective recycling.

## CERTIFICATIONS AND REGULATIONS

Chairs, Tables and Stools by Infiniti are resistant and last various kinds of strains; for this reasons they are tested by CATAS Institute/ TÜV or COSMOB to comply with requirements of UNI and UNI EN norms. On the following we have listed the UNI rules and respective tests that are carried out on chairs:

• UNI EN 1022 Norm (Stability).

• UNI EN 1728 (Static load on seat-back, fatigue resistance on seat-back, static load on side legs, impact on seat, impact on back, front seat edge resistance, vertical and horizontal static load on arm, fatigue on arm, static load on front legs).

Some products of Infiniti’s collection are certified by GS mark. The GS or “Geprüfte Sicherheit” (tested safety) Mark is a voluntary certification mark applied to finished products that signifies their compliance with all of the statutory requirements of the German Product Safety Act (ProdSG). The scope of the GS Mark includes essential product characteristics such as electrical safety, chemical and hazardous material use, ergonomics and noise, and also covers an evaluation of a manufacturer’s factory production. The GS Mark on a product remains valid provided that a manufacturer submits to an annual inspection of its production facilities.

## LETTURA DEL LISTINO

Questo listino contiene una serie di informazioni tecniche e consigli d’uso per chi vuole acquistare o possiede già articoli facenti parte dell’ampia gamma Infiniti. Come visibile dall’indice, il listino suddivide le collezioni in: sedie, poltroncine, sgabelli, tavoli. Tutte le indicazioni presenti a listino sono presentate in triplice lingua: italiano, inglese e spagnolo. Infiniti si riserva la facoltà di apportare modifiche o migliorie al prodotto senza alcun preavviso.

### COME UTILIZZARE IL LISTINO

Le pagine del listino contengono tutte le informazioni necessarie per una completa descrizione del prodotto. In particolare, per ogni prodotto sono indicati:

- Foto del prodotto;
- Nome dell’articolo;
- Tabella con:
  - finiture di telaio e scocca per sedie e sgabelli;
  - finiture della struttura e del ripiano per quanto riguarda i tavoli;
  - prezzi Iva esclusa.
- Quantità di pezzi contenuta in ogni cartone;
- Tutti i colori disponibili di scocca, telaio e ripiano;
- Una breve descrizione del prodotto;
- Le dimensioni di massima del prodotto;
- I dettagli tecnici che descrivono le caratteristiche per unità di imballo:
  - volume dell’imballo;
  - numero di pezzi contenuti in ogni imballo;
  - peso dell’articolo;
  - impilabilità dell’articolo;
  - certificazioni attestate; possibilità di utilizzo del prodotto in esterni.

Nella rappresentazione dei vari colori è indicato il nome del colore. I colori sono puramente indicativi, attenersi ai campioni per effettuare la scelta.

### NOTE BENE

Il costo di un prodotto in tessuto cliente (COM) si ottiene applicando il prezzo della ecopelle. Il costo di un prodotto con pelle cliente (COM) si ottiene aumentando il prezzo del 10% dell’ecopelle. Per tessuti forniti dal cliente, oltre all’indicazione del dritto e rovescio, si richiede l’altezza in cm 140. I tessuti ci devono pervenire con reso della merce DDP. I toni di colore a campionario, relativi ai tessuti, alla pelle, alle laccature, ai cristalli e alle essenze legno, sono indicativi, in quanto possono variare da partita a partita. Infiniti declina ogni responsabilità in relazione a leggere differenze di colore. Tali differenze possono essere più evidenti per ordini successivi a completamento. Infiniti si riserva il diritto di cambiare o tecnicamente migliorare design e specifiche di ogni suo prodotto in qualsiasi momento e a sua discrezione senza darne preventiva notizia. Si riserva inoltre il diritto di ritirare, sospendere o cessare la produzione di ogni suo prodotto in qualsiasi momento e a sua discrezione senza dame preventivo avviso. Le misure riportate a listino sono indicative. Vi può essere una tolleranza dovuta alla tipologia dei materiali impiegati.

## MATERIALI “INFINITI”

### I METALLI

I metalli costituiscono una parte importante dei nostri prodotti: vengono utilizzati per la realizzazione di telai di sedie e strutture di tavoli. Infiniti ha fatto una lunga e approfondita ricerca sui materiali e sulle tecnologie di lavorazione. Nei nostri stabilimenti abbiamo così raggiunto un’alta specializzazione nella lavorazione dell’acciaio e dell’alluminio.

#### ACCIAIO

L’acciaio è usato nella creazione delle strutture di sedie e di sgabelli, con tubolari a sezione quadrata e rotonda ad alta resistenza o con tondino. Inoltre, grazie a tecnologie avanzate (laser 3D), riusciamo ad ottenere forme sempre più complesse. I prodotti sono disponibili con diverse finiture superficiali ad elevati standard qualitativi (verniciatura, satinatura, cromatura).

### ALLUMINIO

Questo metallo unisce doti di leggerezza con resistenza e naturale bellezza estetica delle superfici. La superficie dell’alluminio può essere anodizzata, un trattamento speciale che ha lo scopo di aumentare la resistenza alla corrosione rendendo la superficie più opaca. Infiniti utilizza l’alluminio in tre modi:

- Pressofusione: le gambe delle sedie lucidate cromate o satinate;
- In tubo d’alluminio anodizzato;
- Extrusione.

### LE MATERIE PLASTICHE

Infiniti, azienda all’avanguardia nel suo settore, punta allo sviluppo innovativo e tecnologico: per la sua produzione usa sia i polimeri termoplastici che termoindurenti. I materiali plastici spaziano dal policarbonato al san al polipropilene, permettendo la realizzazione di una vasta gamma di finiture e caratteristiche differenti. Tutti i materiali plastici sono riciclabili nel rispetto dell’ambiente.

### POLIPROPILENE PP

La sua peculiarità principale è una elevata resistenza termica come pure all’abrasione; è inoltre atossico, antistatico, antimacchia ed antigraffio. Ha un’ottima resistenza agli agenti atmosferici permettendo così la produzione di oggetti che possono stare all’aperto.

#### I LEGNI

Lavoriamo nel rispetto delle norme nazionali ed internazionali per la salvaguardia dell'ambiente e ci avvaliamo di partner e fornitori che appoggiano l'organizzazione non governativa FSC (Forest Stewardship Council) che opera per migliorare la gestione delle foreste in tutto il mondo. Le aziende certificate FSC garantiscono che il legno contenuto nei loro prodotti, proviene da foreste gestite in maniera corretta e responsabile, secondo rigorosi standard ambientali, sociali ed economici. Utilizziamo vernici e colle a bassa emissione di formaldeide e usando razionalmente la materia prima. Il legno che utilizziamo è selezionato tra i migliori disponibili sul mercato e viene sottoposto ad una lavorazione particolare per garantirne resistenza e durata nel tempo. Essendo un materiale naturale si possono verificare differenze nella colorazione del materiale tra una partita e l'altra di legname, differenze che non sono da considerare come un difetto bensì come una garanzia dell'autenticità del legno utilizzato.

#### TRANCIATO DI FRASSINO

Consiste nella sovrapposizione di strati di frassino che formano dei blocchi i quali vengono tranciati perpendicolarmente alla direzione dei vari strati, così facendo si ottengono venature regolari e omogenee.

#### PRECOMPOSTO DI ROVERE

Si ottiene sovrapponendo diversi strati di piallacci sottili di legni della stessa specie che ricreano lo stesso effetto a livello di venatura e colori di legni più pregiati.

#### MULTISTRATI A 3D

Si ottiene sovrapponendo vari fogli di tranciato di legno che vengono incollati a fibra incrociata formando così un compensato unito al precomposto 3D, trattasi di un materiale speciale brevettato che si curva nelle 3 dimensioni senza rotture.

#### FENIX NTM®

Materiale innovativo - nanotech, super opaco - creato per l'interior design. Con una bassa riflessione della luce, la sua superficie è estremamente opaca, anti impronte digitali e piacevolmente soft touch. La parte esteriore di FENIX NTM® NTM è ottenuta con l'ausilio di nanotecnologie ed è caratterizzata da una superficie trattata con resine acriliche di nuova generazione, indurite e fissate attraverso il processo di Electron Beam Curing. Grazie a queste caratteristiche FENIX NTM® si rigenera da eventuali micrograffi superficiali grazie alla termoirparabilità.

#### I TESSUTI

I tessuti che utilizziamo appartengono ad una ampia e articolata gamma di colori e fantasie, tutti assolutamente testati con l'obiettivo di ottenere le migliori caratteristiche prestazionali, tra le quali resistenza all'abrasione e resistenza alla luce artificiale. Utilizzati per rivestire sedie e poltrone, sono offerti in una vasta gamma di colori accessi e brillanti. Disponibile la collezione Kvadrat sinonimo di massima qualità e affidabilità. Disponibile la categoria di tessuto ignifugo e rivestimenti in finte pelli. È previsto anche il tessuto cliente.

#### LE PELLI

Le pelli che caratterizzano i rivestimenti delle creazioni Infiniti sono di assoluta qualità, come le pelli fiore provenienti da bovini europei. Numerose sono le possibilità di scelta tra pelli di tonalità diverse. Morbide ed eleganti, ma al tempo stesso molto resistenti, sono il risultato di lunghe fasi di lavorazione. La pelle viene conciata al cromo e pigmentata con resine in soluzione acquosa e per ottenere il giusto grado di morbidezza ed elasticità sono numerosi i test a cui i campioni di pelle vengono sottoposti.

#### RECYCLED FIBERGLASS

Il pannello Recycled Fibreglass è realizzato in compositi fibro-rinforzati riciclati (vetrorina-kevlar-fibra di carbonio, etc) finemente lavorati e riaggregati a pressione elevata con percentuali minime di collanti vergini. Il procedimento è brevettato e genera un materiale double-green, quindi nuovamente riciclabile a fine vita. Nella fresatura, la densità omogenea del pannello (100 kg/m3) garantisce robustezza all'intera sezione, permettendo una lavorazione tridimensionale senza rischio di sfibramento. Il pannello recomplax® T10 è un materiale sostenibile certificato da CSI. Reazioni al fuoco: Classe 2 secondo la UNI9177.

## USO E MANUTENZIONE

Per una manutenzione ottimale dei prodotti Infiniti e per mantenere inalterate le caratteristiche dei materiali con cui sono realizzati, sono necessarie alcune semplici attenzioni:

#### LE MATERIE PLASTICHE

Pulizia: le superfici in plastiche vanno generalmente pulite con un panno umido e soffice imbevuto di acqua, è sconsigliato l'uso di panni asciutti che con lo sfregamento potrebbero caricare elettrostaticamente la superficie plastica attirando polvere. Per le macchie più ostinate è possibile diluire in acqua del sapone liquido neutro con moderazione. Evitare assolutamente l'uso di acetone, trielina, ammoniaca o detersivi che contengono anche solo una piccola quantità di questi detergenti perché possono opacizzare la lucentezza delle superfici. Evitare nel modo più assoluto tutte le sostanze abrasive, come i detersivi in polvere, le paste abrasive, le pagliette o spugne ruvide. Uso: evitare di trascinare sulle superfici oggetti che possono rigare il materiale. Si ricordi in oltre, che i materiali plastici non possono sopportare fonti di calore diretta sulla superficie, come il contatto diretto con pentole e tegami.

#### I LEGNI

Pulizia: pulire con un panno umido e soffice imbevuto di acqua tiepida. Asciugare sempre dopo la pulizia. Rimuovere immediatamente eventuali sostanze liquide o altri residui per evitare l'assorbimento. Uso: le superfici in legno, essendo lo stesso un materiale naturale, potrebbero subire delle alterazioni di colore con l'utilizzo e nel tempo. Si ricordi che i legni non possono sopportare fonti di calore diretta sulla superficie, come appoggiare pentole e tegami direttamente sulla superficie. L'esposizione duratura potrebbe alterarne la colorazione.

#### I METALLI

Pulizia: sia le superfici metalliche in acciaio o alluminio che le superfici verniciate devono essere pulite con un panno umido e soffice imbevuto di acqua calda; per le macchie più ostinate è possibile diluire in acqua del sapone liquido neutro, con moderazione. Asciugare sempre dopo la pulizia con un panno morbido o con pelle di daino. Non usare creme e paste per pulire forni in acciaio, non usare cloro, non usare candeggina ed altri detergenti aggressivi. Sconsigliato usare paste abrasive, pagliette e spugne abrasive che possono graffiare le superfici metalliche. Uso: fare attenzione a macchie di alimenti come il caffè, succhi di frutta,

cola che se non vengono rimossi immediatamente possono lasciare macchie indelebili sulla superficie.

#### I TESSUTI

Pulizia: consultare i consigli per la manutenzione e lavaggio nelle finiture. Uso: ricordiamo che i tessuti sono delicati, è importante prestare attenzione al tipo di lavaggio consigliato e prestare cura durante l'uso poiché soggetti a strappi o tagli.

#### LE PELLI

Pulizia: pulire con panno morbido imbevuto di acqua. Uso: ricordiamo che la pelle ed il cuoio sono delicati; è importante prestare attenzione al tipo di pulizia consigliato e prestare cura durante l'uso poiché soggette a strappi o tagli. L'esposizione in ambienti o luoghi con alto tasso di umidità può causare modificazioni della struttura.

## RICICLABILITÀ

La gamma dei prodotti Infiniti è costituita per la maggior parte da elementi in metallo, in materiale plastico o in legno, tutti materiali interamente riciclabili. Il metallo ad esempio è il materiale tra i più riciclati al mondo e permette di risparmiare il 95% dell'energia che si utilizza normalmente per produrlo dalla materia prima. I metalli raccolti vengono avviati in appositi centri per essere divisi in ferrosi e non ferrosi mediante magneti, metodi di flottazione, aria e manualmente. Analisi chimiche possono essere effettuate per suddividere in modo omogeneo i rifiuti. I materiali non ferrosi, tra i quali il più importante è l'alluminio, vengono pressati in balle e inviate alle fonderie. Qui i metalli sono fusi e il processo di produzione del metallo ricomincia dall'inizio, tornando materia prima, pronta per essere utilizzata per la produzione di nuovi prodotti. La riutilizzabilità, riciclabilità e recuperabilità sono obiettivi importanti della politica UE dell'ambiente che regola l'impiego delle materie plastiche, ormai parte integrante della nostra vita quotidiana. La plastica ebbe a suo tempo un successo immediato e globale proprio per le sue caratteristiche distintive, la plastica infatti ha la possibilità di essere modellata in qualsiasi forma e dimensione, attraverso tecniche di lavorazione diverse a seconda del prodotto: per colata, per stampaggio, per estrusione, per iniezione. I suoi più importanti punti di forza sono; leggerezza e lavorabilità. Il nostro mondo sembra ormai essere avvolto in un foglio di plastica. La produzione di plastica incide infatti solo per il 1,6 % sul consumo europeo di petrolio. Le materie sintetiche più utilizzate sono quelle dette termoplastiche, ovvero polimeri che possono essere lavorati e modellati a caldo e raffreddati bruscamente per mantenerne la forma voluta. Il processo è reversibile garantendone così l'elevata riciclabilità. La plastica per le sue svariate proprietà, è presente in molteplici prodotti "Infiniti". Alla fine del suo utilizzo, la plastica può essere riutilizzata secondo tre modalità fondamentali: il riciclaggio meccanico, che prevede la trasformazione da materia a materia; il rifiuto di plastica diventa il punto di partenza per nuovi prodotti; il riciclaggio chimico che prevede il ritorno alla materia prima di base attraverso la trasformazione dei rifiuti di plastiche in materia da utilizzare nuovamente nella produzione; il recupero energetico, cioè utilizzo dell'energia contenuta nei rifiuti plastici, che deriva dal petrolio e che è interamente sfruttabile. È attraverso il riciclaggio, dunque, che la plastica può tornare a nuova vita. Per semplificare il processo di riciclaggio, i prodotti Infiniti sono facilmente disassemblabili e riconducibili ad elementi monomaterici. Sui gli elementi in plastica sono impressi marchi di identificazione secondo le normative europee per consentire la corretta separazione degli elementi ed il loro effettivo riciclo.

## CERTIFICAZIONI E NORMATIVE

Sedie, Tavoli e Sgabelli Infiniti sono resistenti e sopportano sollecitazioni di varia natura: per questo motivo vengono testati dall'ente Catas per soddisfare i requisiti delle normative UNI e UNI EN. Per il settore domestico è sufficiente il raggiungimento del 3° livello. Di seguito elenchiamo le normative di riferimento UNI e le relative prove che vengono eseguite sulle sedie: Normativa UNI EN 1022/98 (Stabilità); Normativa UNI EN 1728/00 (Carico statico su sedile-schienale, resistenza a fatica del sedile-schienale, carico statico sulle gambe laterali, urto sul sedile, urto sullo schienale, resistenza del fronte anteriore del sedile, carico statico verticale ed orizzontale sul bracciolo, fatica del bracciolo, carico statico gambe anteriori).

Alcuni prodotti della collezione Infiniti hanno ottenuto la certificazione GS. Il marchio GS o "Geprüfte Sicherheit" (sicurezza comprovata) è una certificazione volontaria basata sulla legge per la sicurezza dei prodotti (ProdSG) vigente in Germania e indica la conformità di un prodotto agli standard di sicurezza validi sia nel paese stesso che in Europa. Riconosciuto a livello globale, anche nella supply chain, così come il marchio TÜV SÜD il marchio GS viene rilasciato al completamento del relativo programma di verifica e ispezione e rimane valido a condizione che venga eseguita ogni anno un'ispezione di controllo sulla produzione. L'ottenimento del marchio GS dimostra l'impegno di un'azienda per la salvaguardia della salute dei consumatori e incrementa l'affidabilità dei prodotti.

## SYMBOLS



Indicates that the product has passed the stress resistance tests, and has therefore been certified.



Indicates that the product is stackable.



Indicates the product suitable for outdoor use



Indicates product with swivel function



Indicates product provided with gas seat height adjustment



Finishes chair / Stool finishes



Frame finish



Shell finishes / Seat and backrest finishes



Seat finishes / Seat panel finishes



Finishes seat / Backrest finishes



Indicates that the item is suitable for indoor outdoor applications



Box size



Fireproof

# POST-CONSUMER RECYCLING PRODUCTS

# POST-CONSUMER RECYCLING PRODUCTS



CANOVA PCR

INFINITI TAKES A CHANCE, CREATING A VERY SPECIAL VERSION OF CANOVA, TONDINA AND PURE LOOP IN TWO COLOURS: CARAMEL AND MOKKA.



PCR02  
Caramel



PCR01  
Mokka



TONDINA PCR

THANKS TO THE PRODUCTION TECHNIQUE AND THE DIFFERENT COMPOSITIONS OF PLASTIC, THE FINAL EFFECT ON THE PRODUCT WILL ALWAYS LOOK DIFFERENT FROM A CHAIR TO ANOTHER, EVEN IF THEY WILL BE PRODUCED IN SERIES.



PURE LOOP PCR



FRAME  
PCR01  
Mokka

UPHOLSTERY  
RV284  
Revive 1 Kvadrat

FRAME  
PCR02  
Caramel

UPHOLSTERY  
RV454  
Revive 1 Kvadrat

# CANOVA PCR

DESIGN:  
**CLAUS BREINHOLT**

PCR PLASTIC IS MOLDED INTO A SINUOUS AND LIGHT MONOBLOC, MADE EVEN MORE COMFORTABLE BY THE SEAT PANEL THAT CAN BE COVERED WITH A WIDE RANGE OF FABRICS.

**NEW FINISHES**



FRAME  
PCR01  
Mokka

UPHOLSTERY  
RV284  
Revive 1 Kvadrat

**FRAME**

PCR

Post-Consumer Recycling



PCR01  
Mokka



PCR02  
Caramel

**UPHOLSTERY AVAILABLE**

**FULL-GRAIN LEATHER**

REVIVE 1 Kvadrat  
100% PE FR ric.

UMAMI Kvadrat  
90% WO, 10% PA

PATINA Camira  
69% WO, 22% FL, 8% PQ, 1% VI

MIAMI Pintail  
88% PL, 12% PE

**ECO LEATHER**

76% PVC, 2% PU, 22% PES

FIELD Kvadrat  
100% TREVIRA

CAVA 3 Kvadrat  
90% WO, 10% PA

FLASH No-Shrink  
100% PP

PATIO  
90% WO, 10% PA

CANVAS Kvadrat  
90% WO, 10% PA

HARALD Kvadrat  
100% WO

BYTE  
100% PL

DIVINA 3 Kvadrat  
100% WO

RECHECK Kvadrat  
90% WO, 10% NY

DISCO COEX by Chiocciarello  
70% CO, 20% AC, 5% VI, 5% LI

DIVINA MELANGE 2 Kvadrat  
100% WO

FIORD Kvadrat  
92% WO, 8% NY

STEELCUT 3 Kvadrat  
90% WO, 10% PA

GLOW Kvadrat  
90% WO, 10% NY

**CANOVA  
UPHOLSTERED SEAT**

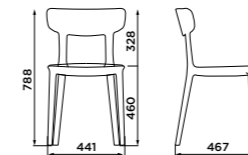

h Frame

h Upholstery

PCR  
Post-Consumer  
Recycling

- Flash/Byte
- Eco Leather
- Patina
- Revive/Disco Coex
- Field/Cava
- Umami/Canvas/Steelcut/Recheck/Glow
- MIAMI Pintail
- Patio Kvadrat
- Divina3/DivinaMelange/Fiord/Harald
- Full Grain Leather
- COM fabric 0,60mt
- COM leather 0,60mq

2 PC  
12,8 Kg / A= 53 cm / B= 67cm / h= 100cm







FRAME  
PCR01  
Mokka

UPHOLSTERY  
CV364  
Canvas Kvadrat

FRAME  
PCR02  
Caramel

UPHOLSTERY  
CV734  
Canvas Kvadrat

# TONDINA PCR

DESIGN:

**FAVARETTO&PARTNERS**

THE PCR PLASTIC OF THE SEAT AND BACKREST PANELS ACCENTUATE THE SOFTNESS OF THE SHAPES OF TONDINA, DECORATING EVERY ENVIRONMENT WITH A STRONG PERSONALITY.

**NEW FINISHES**

SEAT AND BACKREST  
PCR02  
Caramel

FRAME  
AC31  
Black matt painted

**FRAME**

STEEL



AC01  
Chrome plated



AC30  
White matt painted



AC31  
Black matt painted



AC12  
Black chrome plated



AC13  
Copper plated

**SEAT AND BACKREST**

PCR

Post-Consumer Recycling



PCR01  
Mokka



PCR02  
Caramel

**TONDINA PCR**  
4 LEGS

Frame

Seat and backrest

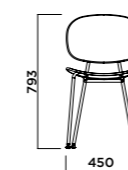

AC  
Matt painted steel

AC  
Chromium-plated steel

AC  
Coloured chromium-plated steel

PCR  
Post-Consumer  
Recycling

2 PCS  
12,2 Kg / A= 47,5cm / B= 63cm / h= 87cm



SHELL  
PCR01  
Mokka

FRAME  
AC31  
Black matt  
painted

SHELL  
PCR02  
Caramel

FRAME  
AC31  
Black matt  
painted

# PURE LOOP PCR

DESIGN:

**CLAUS BREINHOLT**

THE BEST SELLER MONOSHELL CHANGES SKIN AND WEARS POST-CONSUMER PLASTIC, COMMITTING ITSELF TO BECOMING THE NEW SUSTAINABLE ALMOST ICON.

**NEW FINISHES**



SHELL  
PCR02  
Caramel

FRAME  
AC31  
Black matt painted

**FRAME**

STEEL FRAME



AC01  
Chrome plated



AC30  
White matt painted



AC31  
Black matt painted



AC32  
Grey matt painted

**SHELL**

PCR

Post-Consumer Recycling



PCR01  
Mokka



PCR02  
Caramel

**PURE LOOP PCR  
SLED**

h Frame

h Shell

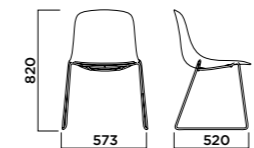

AC  
Matt painted steel

PCR  
Post-Consumer  
Recycling

AC  
Chromium-plated steel

4 PCS  
28,3 Kg / A= 64 cm / B=60 cm / h=97 cm

# NEW PRODUCTS

NEW MATERIALS, FABRICS AND SHAPES ENRICH THE ALREADY WIDE VARIETY OF INFINITI, FITTING HARMONIOUSLY INTO CONTRACT PROJECTS CHARACTERIZED BY HIGH DESIGN. WE PRESENT NEW CHAIRS AND TABLES CREATED TO ENCOURAGE RELATIONSHIPS, GOOD VIBES AND HARMONY, IN ENVIRONMENTS DESIGNED TO BE SOCIAL.

# SICLA

DESIGN:

**CLAUS BREINHOLT**

SICLA IS A RIGID "BUCKET" CHAIR, MADE OF A COMFORTABLE LIGHTWEIGHT AND THIN SHELL. TO PROVIDE STRENGTH THE EDGES AROUND THE SHELL HAVE BEEN CURVED. TO AVOID THE "HOLLOW" SENSATION OF THE SHAPE, A RIB WAS INSERTED AROUND THE BACK OF THE CHAIR, LEADING OUT INTO THE ARMREST AND GIVING STABILITY.

**NEW PRODUCT**





SHELL  
PP503  
Powder blue

FRAME  
AC31  
Black matt painted

— THE RIB IN THE BACK PROVIDES STABILITY TO THE REST OF THE CHAIR, GIVING ALSO A GOOD GRIP ON THE ARMREST WHEN LIFTING IT. THIS MAKES SICLA THE PERFECT CHAIR FOR COMMERCIAL ENVIRONMENTS. THE SHELL CAN HAVE UPHOLSTERED SEAT PANEL OR FULL UPHOLSTERY.

<b>FRAME</b>							
<b>STEEL</b>		AC01 Chrome plated	AC30 White matt painted	AC31 Black matt painted			
<b>ALUMINIUM</b>							
<b>ROCKING</b>		AL07 Polished	AL30 White matt painted	AL31 Black matt painted			
<b>STEEL</b>							
<b>SOLID ASH</b>			AC31 Black matt painted	AC01 Chromium-plated			
<b>SHELL</b>							
<b>POLYPROPYLENE</b>		PP20 White	PP31 Coal black	PP514 Sand	PP34 Peach	PP503 Powder blue	PP513 Military green
<b>UPHOLSTERY AVAILABLE</b>							
<b>FULL-GRAIN LEATHER</b>		<b>ECO LEATHER</b> 76% PVC, 2% PU, 22% PES					
REVIVE 1 Kvadrat 100% PE FR ric.	FIELD Kvadrat 100% TREVIRA	CANVAS Kvadrat 90% WO, 10% PA	DIVINA 3 Kvadrat 100% WO	DIVINA MELANGE 2 Kvadrat 100% WO	STEELCUT 3 Kvadrat 90% WO, 10% PA		
UMAMI Kvadrat 90% WO, 10% PA	CAVA 3 Kvadrat 90% WO, 10% PA	HARALD Kvadrat 100% WO	RECHECK Kvadrat 90% WO, 10% NY	FIORD Kvadrat 92% WO, 8% NY	GLOW Kvadrat 90% WO, 10% NY		
PATINA Camira 69% WO, 22% FL, 8% PQ, 1% VI	FLASH No-Shrink 100% PP	BYTE 100% PL	DISCO COEX by Chioccarello 70% CO, 20% AC, 5% VI, 5% LI				

<b>SICLA</b> 4 LEGS		
	AC Matt painted steel	PP Polypropylene
	AC Chromium-plated steel	PP Polypropylene
	1 PCS 8,3 Kg / A= 59 cm / B= 63 cm / h= 82,5cm	

<b>SICLA</b> SLED		
	AC Matt painted steel	PP Polypropylene
	AC Chromium-plated steel	PP Polypropylene
	1 PCS 9,3 Kg / A= 59 cm / B= 63 cm / h= 82,5cm	

<b>SICLA</b> WOODEN LEGS		
	MAFR Natural ash	PP Polypropylene
	MAFR Stained ash	PP Polypropylene
	1 PCS 7,1 Kg / A= 59 cm / B= 63 cm / h= 82,5cm	

<b>SICLA</b> 4 STAR ALUMINIUM BASE		
	AL Polished aluminium	PP Polypropylene
	AL Matt painted aluminium	PP Polypropylene
	1 PCS 9,2 Kg / A= 59 cm / B= 63 cm / h= 82,5cm	

<b>SICLA</b> SWIVEL WITH CASTORS		
	AL Polished aluminium	PP Polypropylene
	AL Matt painted aluminium	PP Polypropylene
	1 PCS 9,2 Kg / A= 59 cm / B= 63 cm / h= 82,5cm	



**SICLA**  
ROCKING

h Frame

h Shell

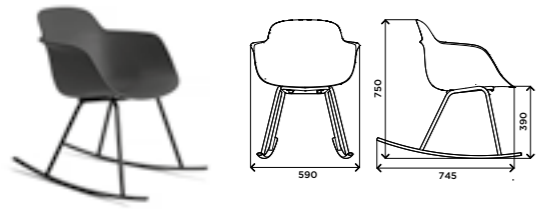
AC  
Matt painted steelPP  
PolypropyleneAC  
Chromium-plated steelPP  
Polypropylene

1 PCS  
9,5 Kg / A= 81 cm / B= 81 cm / h= 110,5cm

**SICLA**  
4 LEGS UPHOLSTERED PANEL

h Frame

h Upholstery

AC  
Matt painted steelFlash/Byte  
Eco Leather  
Patina  
Revive/Disco Coex  
Field/Cava  
Umami/Canvas/Steelcut/Recheck/Glow  
Divina3/DivinaMelange/Fjord/Harald  
Full Grain Leather  
COM fabric 0,60mt  
COM leather 0,50mqAC  
Chromium-plated steelFlash/Byte  
Eco Leather  
Patina  
Revive/Disco Coex  
Field/Cava  
Umami/Canvas/Steelcut/Recheck/Glow  
Divina3/DivinaMelange/Fjord/Harald  
Full Grain Leather  
COM fabric 0,60mt  
COM leather 0,50mq

1 PCS  
8,3 Kg / A= 59 cm / B= 63 cm / h= 82,5cm

**SICLA**  
SLED UPHOLSTERED SEAT PANEL

h Frame

h Upholstery

AC  
Matt painted steelFlash/Byte  
Eco Leather  
Patina  
Revive/Disco Coex  
Field/Cava  
Umami/Canvas/Steelcut/Recheck/Glow  
Divina3/DivinaMelange/Fjord/Harald  
Full Grain Leather  
COM fabric 0,60mt  
COM leather 0,50mqAC  
Chromium-plated steelFlash/Byte  
Eco Leather  
Patina  
Revive/Disco Coex  
Field/Cava  
Umami/Canvas/Steelcut/Recheck/Glow  
Divina3/DivinaMelange/Fjord/Harald  
Full Grain Leather  
COM fabric 0,60mt  
COM leather 0,50mq

1 PCS  
9,3 Kg / A= 59 cm / B= 63 cm / h= 82,5cm

**SICLA**  
WOODEN LEGS  
UPHOLSTERED SEAT PANEL

h Frame

h Upholstery

MAFR  
Natural ashFlash/Byte  
Eco Leather  
Patina  
Revive/Disco Coex  
Field/Cava  
Umami/Canvas/Steelcut/Recheck/Glow  
Divina3/DivinaMelange/Fjord/Harald  
Full Grain Leather  
COM fabric 0,60mt  
COM leather 0,50mqMAFR  
Stained ashFlash/Byte  
Eco Leather  
Patina  
Revive/Disco Coex  
Field/Cava  
Umami/Canvas/Steelcut/Recheck/Glow  
Divina3/DivinaMelange/Fjord/Harald  
Full Grain Leather  
COM fabric 0,60mt  
COM leather 0,50mq

1 PCS  
7,1 Kg / A= 59 cm / B= 63 cm / h= 82,5cm

**SICLA**  
4 STAR ALUMINIUM BASE  
UPHOLSTERED SEAT PANEL

h Frame

h Upholstery

AL  
Polished aluminiumFlash/Byte  
Eco Leather  
Patina  
Revive/Disco Coex  
Field/Cava  
Umami/Canvas/Steelcut/Recheck/Glow  
Divina3/DivinaMelange/Fjord/Harald  
Full Grain Leather  
COM fabric 0,60mt  
COM leather 0,50mqAL  
Matt painted aluminiumFlash/Byte  
Eco Leather  
Patina  
Revive/Disco Coex  
Field/Cava  
Umami/Canvas/Steelcut/Recheck/Glow  
Divina3/DivinaMelange/Fjord/Harald  
Full Grain Leather  
COM fabric 0,60mt  
COM leather 0,50mq

1 PCS  
9,2 Kg / A= 59 cm / B= 63 cm / h= 82,5cm

**SICLA**  
 WITH CASTORS  
 UPHOLSTERED SEAT PANEL

Frame

Upholstery

 AL  
 Polished aluminium

 Flash/Byte  
 Eco Leather  
 Patina  
 Revive/Disco Coex  
 Field/Cava  
 Umami/Canvas/Steelcut/Recheck/Glow  
 Divina3/DivinaMelange/Fjord/Harald  
 Full Grain Leather  
 COM fabric 0,60mt  
 COM leather 0,50mq

 AL  
 Matt painted aluminium

 Flash/Byte  
 Eco Leather  
 Patina  
 Revive/Disco Coex  
 Field/Cava  
 Umami/Canvas/Steelcut/Recheck/Glow  
 Divina3/DivinaMelange/Fjord/Harald  
 Full Grain Leather  
 COM fabric 0,60mt  
 COM leather 0,50mq

 1 PCS  
 9,2 Kg / A= 59 cm / B= 63 cm / h= 82,5cm

**SICLA**  
 4 LEGS  
 FULL UPHOLSTERED PANEL

Frame

Upholstery

 AC  
 Matt painted steel

 Flash/Byte  
 Eco Leather  
 Patina  
 Revive/Disco Coex  
 Field/Cava  
 Umami/Canvas/Steelcut/Recheck/Glow  
 Divina3/DivinaMelange/Fjord/Harald  
 Full Grain Leather  
 COM fabric 1,00mt  
 COM leather 120mq

 AC  
 Chromium-plated steel

 Flash/Byte  
 Eco Leather  
 Patina  
 Revive/Disco Coex  
 Field/Cava  
 Umami/Canvas/Steelcut/Recheck/Glow  
 Divina3/DivinaMelange/Fjord/Harald  
 Full Grain Leather  
 COM fabric 1,00mt  
 COM leather 120mq

 1 PCS  
 8,3 Kg / A= 59 cm / B= 63 cm / h= 82,5cm

**SICLA**  
 ROCKING  
 UPHOLSTERED SEAT PANEL

Frame

Upholstery

 AC  
 Matt painted steel

 Flash/Byte  
 Eco Leather  
 Patina  
 Revive/Disco Coex  
 Field/Cava  
 Umami/Canvas/Steelcut/Recheck/Glow  
 Divina3/DivinaMelange/Fjord/Harald  
 Full Grain Leather  
 COM fabric 0,60mt  
 COM leather 0,50mq

 AC  
 Chromium-plated steel

 Flash/Byte  
 Eco Leather  
 Patina  
 Revive/Disco Coex  
 Field/Cava  
 Umami/Canvas/Steelcut/Recheck/Glow  
 Divina3/DivinaMelange/Fjord/Harald  
 Full Grain Leather  
 COM fabric 0,60mt  
 COM leather 0,50mq

 1 PCS  
 9,5 Kg / A= 81 cm / B= 81 cm / h= 110,5cm

**SICLA**  
 SLED  
 FULL UPHOLSTERED PANEL

Frame

Upholstery

 AC  
 Matt painted steel

 Flash/Byte  
 Eco Leather  
 Patina  
 Revive/Disco Coex  
 Field/Cava  
 Umami/Canvas/Steelcut/Recheck/Glow  
 Divina3/DivinaMelange/Fjord/Harald  
 Full Grain Leather  
 COM fabric 1,00mt  
 COM leather 120mq

 AC  
 Chromium-plated steel

 Flash/Byte  
 Eco Leather  
 Patina  
 Revive/Disco Coex  
 Field/Cava  
 Umami/Canvas/Steelcut/Recheck/Glow  
 Divina3/DivinaMelange/Fjord/Harald  
 Full Grain Leather  
 COM fabric 1,00mt  
 COM leather 120mq

 1 PCS  
 9,3 Kg / A= 59 cm / B= 63 cm / h= 82,5cm

**SICLA**  
 WOODEN LEGS  
 UPHOLSTERED SEAT PANEL

 Frame

 Upholstery

**MAFR**  
 Natural ash

 Flash/Byte  
 Eco Leather  
 Patina  
 Revive/Disco Coex  
 Field/Cava  
 Umami/Canvas/Steelcut/Recheck/Glow  
 Divina3/DivinaMelange/Fjord/Harald  
 Full Grain Leather  
 COM fabric 1,00mt  
 COM leather 120mq

**MAFR**  
 Stained ash

 Flash/Byte  
 Eco Leather  
 Patina  
 Revive/Disco Coex  
 Field/Cava  
 Umami/Canvas/Steelcut/Recheck/Glow  
 Divina3/DivinaMelange/Fjord/Harald  
 Full Grain Leather  
 COM fabric 1,00mt  
 COM leather 120mq

 **1 PCS**  
 7,1 Kg / A= 59 cm / B= 63 cm / h= 82,5cm

**SICLA**  
 SWIVEL WITH CASTORS  
 FULL UPHOLSTERED PANEL

 Frame

 Upholstery

**AL**  
 Polished aluminium

 Flash/Byte  
 Eco Leather  
 Patina  
 Revive/Disco Coex  
 Field/Cava  
 Umami/Canvas/Steelcut/Recheck/Glow  
 Divina3/DivinaMelange/Fjord/Harald  
 Full Grain Leather  
 COM fabric 1,00mt  
 COM leather 120mq

**AL**  
 Matt painted aluminium

 Flash/Byte  
 Eco Leather  
 Patina  
 Revive/Disco Coex  
 Field/Cava  
 Umami/Canvas/Steelcut/Recheck/Glow  
 Divina3/DivinaMelange/Fjord/Harald  
 Full Grain Leather  
 COM fabric 1,00mt  
 COM leather 120mq

 **1 PCS**  
 9,2 Kg / A= 59 cm / B= 63 cm / h= 82,5cm

**SICLA**  
 4 STAR ALUMINIUM BASE  
 UPHOLSTERED SEAT PANEL

 Frame

 Upholstery

**AL**  
 Polished aluminium

 Flash/Byte  
 Eco Leather  
 Patina  
 Revive/Disco Coex  
 Field/Cava  
 Umami/Canvas/Steelcut/Recheck/Glow  
 Divina3/DivinaMelange/Fjord/Harald  
 Full Grain Leather  
 COM fabric 1,00mt  
 COM leather 120mq

**AL**  
 Matt painted aluminium

 Flash/Byte  
 Eco Leather  
 Patina  
 Revive/Disco Coex  
 Field/Cava  
 Umami/Canvas/Steelcut/Recheck/Glow  
 Divina3/DivinaMelange/Fjord/Harald  
 Full Grain Leather  
 COM fabric 1,00mt  
 COM leather 120mq

 **1 PCS**  
 9,2 Kg / A= 59 cm / B= 63 cm / h= 82,5cm

**SICLA**  
 ROCKING  
 FULL UPHOLSTERED PANEL

 Frame

 Upholstery

**AC**  
 Matt painted steel

 Flash/Byte  
 Eco Leather  
 Patina  
 Revive/Disco Coex  
 Field/Cava  
 Umami/Canvas/Steelcut/Recheck/Glow  
 Divina3/DivinaMelange/Fjord/Harald  
 Full Grain Leather  
 COM fabric 1,00mt  
 COM leather 120mq

**AC**  
 Chromium-plated steel

 Flash/Byte  
 Eco Leather  
 Patina  
 Revive/Disco Coex  
 Field/Cava  
 Umami/Canvas/Steelcut/Recheck/Glow  
 Divina3/DivinaMelange/Fjord/Harald  
 Full Grain Leather  
 COM fabric 1,00mt  
 COM leather 120mq

 **1 PCS**  
 9,5 Kg / A= 81 cm / B= 81 cm / h= 110,5cm



FRAME  
AC01  
Black matt painted

SHELL  
PP31  
Coal black

UPHOLSTERY  
RV224  
Revive

FRAME  
AL31  
Black matt painted

SHELL  
PP503  
Powder blue

# EASTWOOD

DESIGN:

**ANDREAS OSTWALD**

IN THE NEW EASTWOOD CHAIR, A SOLID ASH STRUCTURE MEETS POLYPROPYLENE, CREATING AN INTRIGUING INTERSECTION OF SINUOUS LINES. THE SLIGHTLY CURVED BACK PANEL REST GENTLY ON THE FRAME, MAXIMIZING COMFORT. THE COLOR PALETTE FOR THE SEAT AND BACKRESTREST MAKES EASTWOOD MATCHABLE TO ANY CLASSIC AND MODERN SETTING.

NEW PRODUCT



THE CHAIR FRAME IN NATURAL OR BLACK STAINED ASH GENTLY SUPPORTS THE BACKREST AND RECALLS THE COLORS, THANKS TO THE MATCHING POLYPROPYLENE INSERTS.



FRAME  
MAFR09  
Black stained ash

SEAT AND BACKREST  
PP22  
Tobacco

## FRAME

ASH

MAFR01  
Natural ashMAFR09  
Black stained ash

## SEAT AND BACKREST

POLYPROPYLENE

PP20  
WhitePP31  
Coal blackPP22  
TobaccoPP421C  
AlmondPP503  
Powder blue

## EASTWOOD

Frame

Seat and backrest

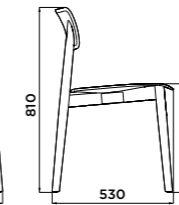
MAFR  
Natural ashPP  
PolypropyleneMAFR  
Stained ashPP  
Polypropylene

2 PCS  
11,5 Kg / A= 70 cm / B=50 cm / h=98 cm



EASTWOOD

FRAME  
MAFR01  
Natural ash

SEAT AND BACKREST  
PP503  
Powder blue

NEXT  
TABLE

LEGS  
MAR03  
Natural oak

TOP  
FX01  
Fenix white

# FELUCA

DESIGN:

**BROGLIATOTRAVERSO**

THE FELUCA HAT ("BECORN HAT" IN ENGLISH) IS AN ANCIENT HEADGEAR USED IN THE EIGHTEENTH CENTURY AND CHARACTERIZED BY TWO DOWNWARD CURVED EXTREMITIES. IT IS NO COINCIDENCE IF BROGLIATOTRAVERSO CHOSE THIS NAME FOR THEIR NEW CHAIR, SINCE THE BACK PANEL HAS A SHAPE THAT STRONGLY REMINDS IT. THIS PARTICULAR DESIGN GIVES A SENSE OF MOVEMENT, ERASING ANY RIGIDITY AND ENHANCING HARMONY AND REFINEMENT.

**NEW PRODUCT**







FRAME  
AC45  
Oxide red fine textured

SEAT AND BACKREST  
LFR01  
Natural

FRAME

STEEL



AC44  
White fine textured



AC57  
Black fine textured



AC41  
Light grey fine textured



AC45  
Oxide red fine textured

SEAT AND BACKREST

ASH



LFR01  
Natural ash



LFR08  
Black stained ash



LFR27  
Grey stained ash

FELUCA



Frame



Seat and backrest

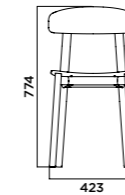

AC  
Fine textured steel

LFR  
Natural ash

AC  
Fine textured steel

LFR  
Stained ash

2 PCS  
12,8 Kg / A= 49 cm / B=69 cm / h=96,5 cm





FRAME  
AC41  
Light grey  
fine textured

SEAT AND BACKREST  
LFR01  
Natural ash

# EKKI

DESIGN:  
**mC.dsg**

MC.DSG WANTS TO PAY HOMAGE TO EARLY TWENTIETH CENTURY DESIGNERS WITH EKKI, A CHAIR WITH A RETRO DESIGN. ENRICHED BY CONTEMPORARY ELEMENTS SUCH AS THE METAL DETAIL PLACED ON THE BACK SIDE OF THE RECTANGULAR BACKREST, AND THE VISIBLE ASSEMBLY COMPONENTS.

**NEW PRODUCT**

















FRAME  
LR03  
Natural oak

SEAT AND BACKREST  
LR03  
Natural oak

DETAIL  
AC44  
White fine textured



— THE WARM TEXTURE OF OAK WELCOMES A DETAIL ON THE BACK OF THE BACKREST: AN ELEMENT IN PAINTED STEEL THAT CAN BECOME ALSO AN ELEGANT ARMREST.

FRAME				
SOLID BEECH				
	MAF24 <i>Black lacquered</i>	MAF25 <i>Grey lacquered</i>	MAF26 <i>Green lacquered</i>	
SOLID OAK				
		LR03 <i>Natural oak</i>	LR08 <i>Black stained oak</i>	
SEAT AND BACKRESTREST				
PLYWOOD BEECH				
	MAF24 <i>Black lacquered</i>	MAF25 <i>Grey lacquered</i>	MAF26 <i>Green lacquered</i>	
PLYWOOD OAK				
	LV06 <i>Stratus Superior American Walnut</i>	LR03 <i>Natural oak</i>	LR08 <i>Black stained oak</i>	
ARMREST				
STEEL				
	AC44 <i>White fine textured</i>	AC57 <i>Black fine textured</i>	AC41 <i>Light grey fine textured</i>	AC58 <i>Green fine textured</i>

EKKI

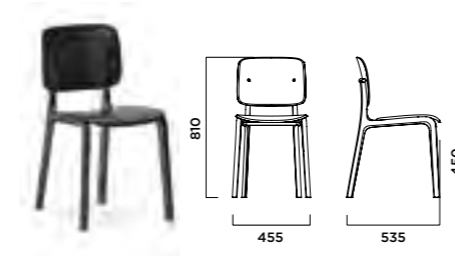
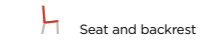

MAF  
Lacquered beech

MAF  
Lacquered beech

LR  
Natural oak/  
Black stained

LR  
Stratus Superior  
American Walnut

LR  
Natural oak/  
Black stained

MAF  
Lacquered beech

LR  
Natural oak/  
Black stained

LR  
Stratus Superior  
American Walnut

2 PCS  
12,5 Kg / A= 60 cm / B=53 cm / h=88,5 cm

EKKI  
WITH ARMS

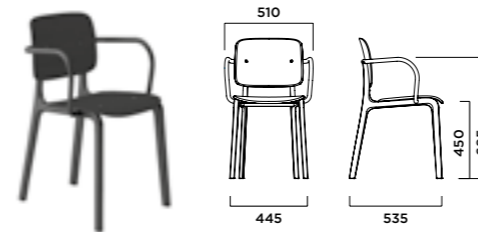
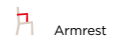
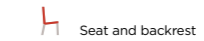

MAF  
Lacquered beech

MAF  
Lacquered beech

LR  
Natural oak/  
Black stained

AC  
Steel

LR  
Stratus Superior  
American Walnut

LR  
Natural oak/  
Black stained

MAF  
Lacquered beech

LR  
Natural oak/  
Black stained

AC  
Steel

LR  
Stratus Superior  
American Walnut

1 PCS  
8 Kg / A= 52 cm / B=58 cm / h=84 cm



## FRAME

LR03  
Natural oak

## SEAT AND BACKREST

LR03  
Natural oak

## DETAIL

AC57  
Black fine textured

# BOMBOM

DESIGN:

**FAVARETTO&PARTNERS**

YOU WILL FIND IN BOMBOM EVERYTHING YOU CAN EXPECT FROM AN ARMCHAIR: SOFTNESS, SMOOTHNESS, FLUFFINESS, SENSATIONS FULLY EVOKED BY ITS NAME. THE ROUNDED SHAPE INVITES YOU TO GET COMFORTABLE ON ITS GENEROUS SEAT.

**NEW PRODUCT**





FRAME  
AC31  
Black matt painted

UPHOLSTERY  
INSIDE FO971  
OUTSIDE FO991  
Fiord Kvadrat

## FRAME

STEEL



AC01  
Cromium-plated



AC31  
Black matt painted



AC12  
Black chrome



AC13  
Copper chrome

## UPHOLSTERY AVAILABLE

## FULL-GRAIN LEATHER

REVIVE 1 Kvadrat  
100% PE FR ric.  
UMAMI Kvadrat  
90% WO, 10% PA  
FLASH No-Shrink  
100% PP

## ECO LEATHER

76% PVC, 2% PU, 22% PES  
FIELD Kvadrat  
100% TREVIRA  
HARALD Kvadrat  
100% WO  
BYTE  
100% PL

CANVAS Kvadrat  
90% WO, 10% PA  
RECHECK Kvadrat  
90% WO, 10% NY

DIVINA 3 Kvadrat  
100% WO  
FIORD Kvadrat  
92% WO, 8% NY

DIVINA MELANGE 2 Kvadrat  
100% WO  
GLOW Kvadrat  
90% WO, 10% NY

STEELCUT 3 Kvadrat  
90% WO, 10% PA  
PATINA Camira  
69% WO, 22% FL, 8% PQ, 1% VI

BOMBOM  
4 LEGS

h Frame

h Upholstery

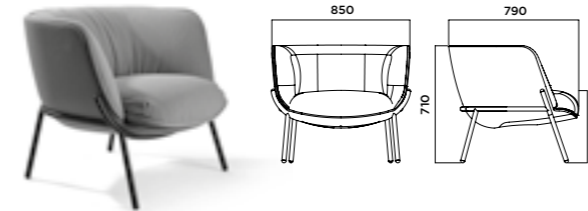

AC  
Matt painted steel

Flash/Byte  
Eco Leather  
Patina  
Revive  
Field/Cava  
Umami/Canvas/Steelcut/Recheck/Glow  
Divina3/DivinaMelange/Fiord/Harald  
Full Grain Leather  
COM fabric IN 2,70mt / OUT 1,50mt  
COM leather IN 4,50mq / OUT 2,5mq

AC  
Chromium-plated steel

Flash/Byte  
Eco Leather  
Patina  
Revive  
Field/Cava  
Umami/Canvas/Steelcut/Recheck/Glow  
Divina3/DivinaMelange/Fiord/Harald  
Full Grain Leather  
COM fabric IN 2,70mt / OUT 1,50mt  
COM leather IN 4,50mq / OUT 2,5mq

AC  
Coloured  
chromium-plated steel

Flash/Byte  
Eco Leather  
Patina  
Revive  
Field/Cava  
Umami/Canvas/Steelcut/Recheck/Glow  
Divina3/DivinaMelange/Fiord/Harald  
Full Grain Leather  
COM fabric IN 2,70mt / OUT 1,50mt  
COM leather IN 4,50mq / OUT 2,5mq

1 PCS  
27,5 Kg / A= 84cm / B= 80cm / h= 78cm

BOMBOM  
4 STAR

h Frame

h Upholstery



AC  
Matt painted steel

Flash/Byte  
Eco Leather  
Patina  
Revive  
Field/Cava  
Umami/Canvas/Steelcut/Recheck/Glow  
Divina3/DivinaMelange/Fiord/Harald  
Full Grain Leather  
COM fabric IN 2,70mt / OUT 1,50mt  
COM leather IN 4,50mq / OUT 2,5mq

AC  
Chromium-plated steel

Flash/Byte  
Eco Leather  
Patina  
Revive  
Field/Cava  
Umami/Canvas/Steelcut/Recheck/Glow  
Divina3/DivinaMelange/Fiord/Harald  
Full Grain Leather  
COM fabric IN 2,70mt / OUT 1,50mt  
COM leather IN 4,50mq / OUT 2,5mq

AC  
Coloured  
chromium-plated steel

Flash/Byte  
Eco Leather  
Patina  
Revive  
Field/Cava  
Umami/Canvas/Steelcut/Recheck/Glow  
Divina3/DivinaMelange/Fiord/Harald  
Full Grain Leather  
COM fabric IN 2,70mt / OUT 1,50mt  
COM leather IN 4,50mq / OUT 2,5mq

1 PCS  
30,6 Kg / A= 84cm / B= 80cm / h= 78cm



**BOMBOM**

FRAME  
AC31  
Black matt painted

UPHOLSTERY  
INSIDE SC446  
OUTSIDE SC453  
Steekut Kvadrat

**DIAPASON TABLE**

BASE	TOP
AC31	FX02
Black	Black

# FLINK TABLE

DESIGN:

**THOMAS PEDERSEN**

THE MINIMALISM OF FLINK FINDS THE PERFECT EXPRESSION IN THE NEW TABLE AVAILABLE IN THREE HEIGHTS, PERFECT FOR BARS, BISTROS, WAITING AREAS. AVAILABLE ALSO WITH OUTDOOR FINISH.

NEW PRODUCT





BASE  
AC40  
Lead grey fine textured

TABLE TOP  
FX03  
Fenix Anthracite

<b>BASE</b>				
STEEL				
		AC20 Embossed white painted	AC03 Embossed black painted	AC40 Lead grey fine textured
<b>TABLE TOP</b>				
STAINLESS STEEL				
	AC20 Embossed white painted	AC03 Embossed black painted	AC40 Lead grey fine textured	Edge 3mm
LAMINATE				
		LM01 White	LM02 Black	Edge 30mm
FENIX NTM*				
	FX01 White	FX02 Black	FX03 Anthracite	Edge 10mm

**FLINK TABLE**

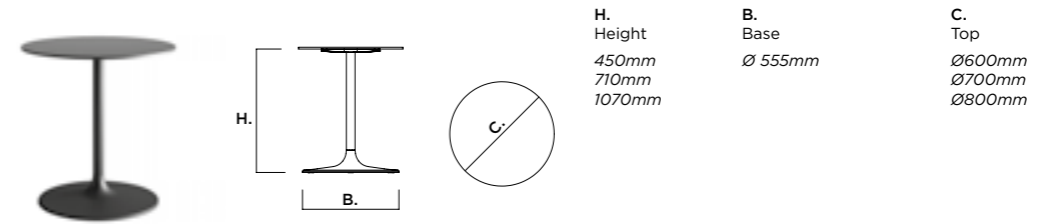

<b>TUBE</b>	WEIGHT	A x B x h
H450mm	1,4 kg	7x7x35 cm
H710mm	2,4 kg	7x7x61 cm
H1070mm	3,5 kg	7x7x97 cm

<b>BASE AND SUPPORT</b>	WEIGHT	A x B x h
<b>BALLAST</b>	8,9 kg	57x57x19 cm
	15 kg	57x57x2 cm

<b>TABLE TOP</b>	WEIGHT  A x B x h			
Ø 600	AC - 7,6 kg	LM - 6,7 kg	FX - 5,9 kg	57x57x19 cm
Ø 700	AC - 10,2 kg	LM - 8,9 kg	FX - 7,4 kg	57x57x2 cm
Ø 800	-	LM - 11,6 kg	FX - 10 kg	57x57x2 cm



## FLINK TABLE

BASE  
AC44  
White fine textured

TABLE TOP  
FX01  
Fenix white

## KLEJN BAR STOOL

FRAME  
AC12  
Black chrome plated

SEAT AND BACKREST  
LFR01  
Natural ash

## FELUCA

FRAME  
AC47  
Dove grey fine textured

SEAT PANEL  
MAR01  
Natural ash

# DIAPASON

DESIGN:

**FAVARETTO&PARTNERS**

STRONGLY ICONIC BUT AT THE SAME TIME ELEGANT CAPABLE OF DECORATING THE MOST DIFFERENT ENVIRONMENTS; TWO HEIGHTS, DIFFERENT TABLE TOPS...DIAPASON MAKES ITS WAY!

NEW PRODUCT





<i>BASE</i>	<i>TABLE TOP</i>
<b>AC31</b>	<b>FX02</b>
<i>Black</i>	<i>Fenix black</i>



<b>DIAPASON TABLE</b>	
<i>BASE</i>	<i>TABLE TOP</i>
<b>AC31</b>	<b>FX02</b>
<i>Black</i>	<i>Black</i>

<b>RELIEF 4 LEGS</b>	
<i>FRAME</i>	<i>UPHOLSTERY</i>
<b>MAFR01</b>	<b>GL143</b>
<i>Natural ash</i>	<i>Glow Kwadrat</i>

<b>BASE</b>				
STEEL		AC31 Black	AC20 Bianco	
<b>TABLE TOP</b>				
STAINLESS STEEL		AC31 Black	AC20 Bianco	Edge 3mm
				
LAMINATE		LM02 Black	LM02 Bianco	Edge 3mm
				
FENIX NTM®		FX02 Black	FX01 Bianco	Edge 3mm

**DIAPASON**  
H 450

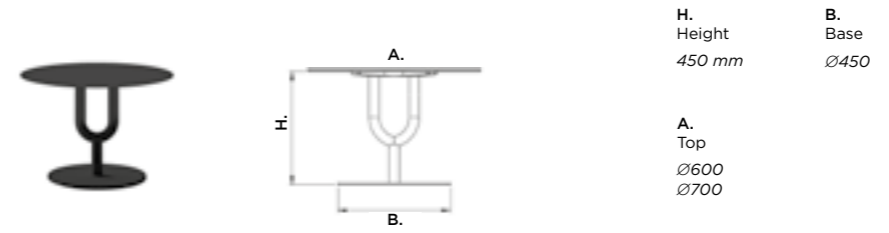

**H.**  
Height  
450 mm

**B.**  
Base  
Ø450

**A.**  
Top  
Ø600  
Ø700

**DIAPASON**  
H 710

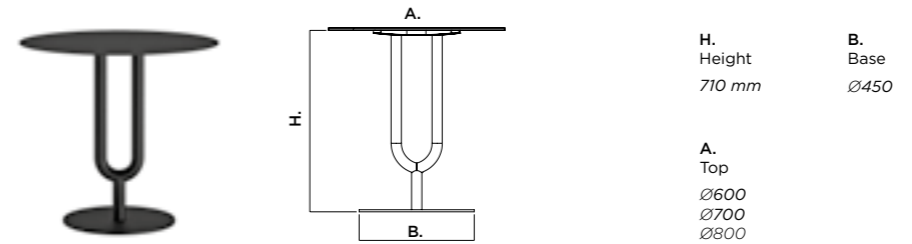

**H.**  
Height  
710 mm

**B.**  
Base  
Ø450

**A.**  
Top  
Ø600  
Ø700  
Ø800

**TUBE**

	WEIGHT	 A x B x h
H450mm	2,5 kg	44x23x5 cm
H710mm	4 kg	73x23x5 cm

**BASE AND SUPPORT**

WEIGHT	 A x B x h
14,1 kg	52,5x51x6 cm

**TABLE TOP**

	WEIGHT			 A x B x h
Ø 600	AC - 7,6 kg	LM - 6,7 kg	FX - 5,9 kg	57x57x19 cm
Ø 700	AC - 10,2 kg	LM - 8,9 kg	FX - 7,4 kg	57x57x2 cm
Ø 800	-	LM - 11,6 kg	FX - 10 kg	57x57x2 cm

# RANGE EXTENSIONS

EVERY INFINITI PRODUCT FOLLOWS  
THE EVOLUTION AND DEMANDS OF  
THE CONTEMPORARY WORLD.  
WE PRESENT THE INFINITI RANGE  
EXTENSIONS: FINISHES, DIMENSIONS,  
UPHOLSTERY DESTINED TO BECOME  
ALMOST ICONS.



# RELIEF

DESIGN:

**FAVARETTO&PARTNERS**

THE RELIEF FAMILY WIDENS: THE POLYPROPYLENE SHELL, SUPPORTED BY DIFFERENT BASES, IS NOW AVAILABLE WITH UPHOLSTERED SEAT AND BACKREST PANELS. THE RANGE IS COMPLETED BY A NEW VERSION WITH A SOLID ASH FRAME, WITH OR WITHOUT ARMS, AVAILABLE ALSO WITH FULLY UPHOLSTERED SHELL.

**RANGE EXTENSION**





WOODEN FRAME  
MAFR09  
Graphite black stained

SHELL  
PT42  
Patina

FRAME

STEEL



AC01 Chrome plated    AC30 White matt painted    AC31 Black matt painted    AC32 Grey matt painted

ALUMINIUM BASE AND SUPPORT



AL07 Polished    AL30 White matt painted    AL31 Black matt painted

WOODEN FRAME

SOLID ASH



MAFR01 Natural    MAFR09 Graphite black stained

SHELL

POLYPROPYLENE



PP20 White    PP31 Coal black    PP07 Cement grey    PP503 Powder blue    PP514 Sand

UPHOLSTERY AVAILABLE

FULL-GRAIN LEATHER

ECO LEATHER  
76% PVC, 2% PU, 22% PES

REVIVE 1 Kvadrat  
100% PE FR ric.

FIELD Kvadrat  
100% TREVIRA

CANVAS Kvadrat  
90% WO, 10% PA

DIVINA 3 Kvadrat  
100% WO

DIVINA MELANGE 2 Kvadrat  
100% WO

STEELCUT 3 Kvadrat  
90% WO, 10% PA

UMAMI Kvadrat  
90% WO, 10% PA

HARALD Kvadrat  
100% WO

RECHECK Kvadrat  
90% WO, 10% NY

FIORD Kvadrat  
92% WO, 8% NY

GLOW Kvadrat  
90% WO, 10% NY

PATINA Camira  
69% WO, 22% FL, 8% PQ, 1% VI

FLASH No-Shrink  
100% PP

BYTE  
100% PL

DISCO COEX by Chioccarello  
70% CO, 20% AC, 5% VI, 5% LI

OPTIONAL ON REQUEST



LINKING DEVICE

RELIEF SLED

RELIEF  
WOODEN LEGS

h Frame

h Shell

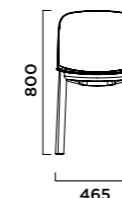

MAFR  
Solid ash

PP  
Polypropylene

MAFR  
Stained ash

PP  
Polypropylene



1 PCS  
8,5 Kg / A= 47,5 cm / B=58 cm / h=83 cm

**RELIEF**  
 WOODEN LEGS WITH ARMS

 Frame

 Shell

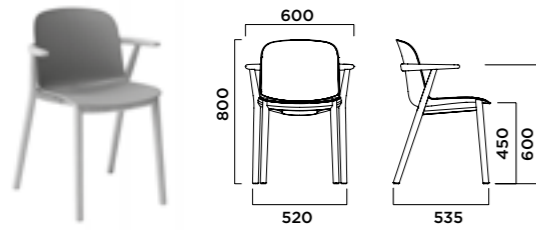
Excluding VAT

MAFR  
Solid ashPP  
PolypropyleneMAFR  
Stained ashPP  
Polypropylene
 **1 PCS**  
 9,5 Kg / A= 63 cm / B=57 cm / h=83 cm

**RELIEF**  
 4 LEGS UPHOLSTERED SEAT

 Frame

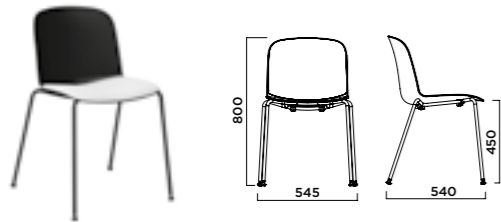
 Upholstery
AC  
Matt painted steel
 Flash/Byte  
 Eco Leather  
 Patina  
 Revive/Disco Coex  
 Field  
 Umami/Canvas/Steelcut/Recheck/Glow  
 Divina3/DivinaMelange/Fjord/Harald  
 Full Grain Leather  
 COM fabric 0,65mt  
 COM leather 0,50mq
AC  
Chromium-plated steel
 Flash/Byte  
 Eco Leather  
 Patina  
 Revive/Disco Coex  
 Field  
 Umami/Canvas/Steelcut/Recheck/Glow  
 Divina3/DivinaMelange/Fjord/Harald  
 Full Grain Leather  
 COM fabric 0,65mt  
 COM leather 0,50mq

 **2 PCS**  
 12 Kg / A= 53,5 cm / B=59 cm / h=89 cm

 <sup>2</sup>
**RELIEF**  
 4 LEGS WITH ARMS UPHOLSTERED SEAT

 Frame

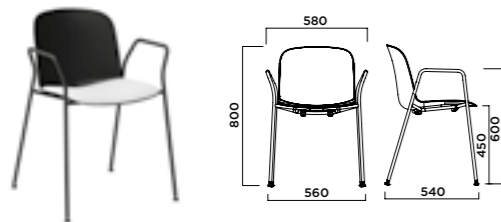
 Upholstery
AC  
Matt painted steel
 Flash/Byte  
 Eco Leather  
 Patina  
 Revive/Disco Coex  
 Field  
 Umami/Canvas/Steelcut/Recheck/Glow  
 Divina3/DivinaMelange/Fjord/Harald  
 Full Grain Leather  
 COM fabric 0,65mt  
 COM leather 0,50mq
AC  
Chromium-plated steel
 Flash/Byte  
 Eco Leather  
 Patina  
 Revive/Disco Coex  
 Field  
 Umami/Canvas/Steelcut/Recheck/Glow  
 Divina3/DivinaMelange/Fjord/Harald  
 Full Grain Leather  
 COM fabric 0,65mt  
 COM leather 0,50mq

 **2 PCS**  
 13,5 Kg / A= 59 cm / B=64 cm / h=97,5 cm

 <sup>2</sup>
**RELIEF**  
 SLED UPHOLSTERED SEAT

 Frame

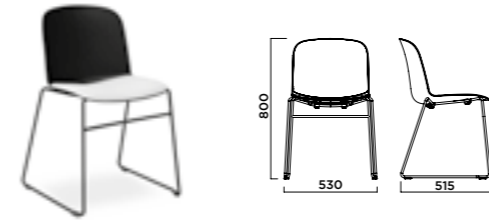
 Upholstery
AC  
Matt painted steel
 Flash/Byte  
 Eco Leather  
 Patina  
 Revive/Disco Coex  
 Field  
 Umami/Canvas/Steelcut/Recheck/Glow  
 Divina3/DivinaMelange/Fjord/Harald  
 Full Grain Leather  
 COM fabric 0,65mt  
 COM leather 0,50mq
AC  
Chromium-plated steel
 Flash/Byte  
 Eco Leather  
 Patina  
 Revive/Disco Coex  
 Field  
 Umami/Canvas/Steelcut/Recheck/Glow  
 Divina3/DivinaMelange/Fjord/Harald  
 Full Grain Leather  
 COM fabric 0,65mt  
 COM leather 0,50mq

 **2 PCS**  
 14,5 Kg / A= 64 cm / B=60 cm / h=97 cm

 <sup>2</sup>
**RELIEF**  
 4 STAR ALUMINIUM BASE  
 UPHOLSTERED SEAT

 Frame

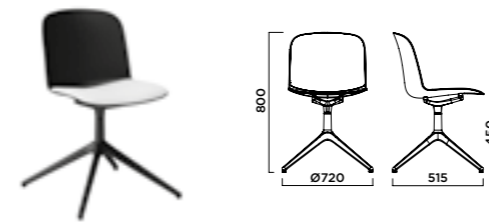
 Upholstery
AL  
Polished aluminium
 Flash/Byte  
 Eco Leather  
 Patina  
 Revive/Disco Coex  
 Field  
 Umami/Canvas/Steelcut/Recheck/Glow  
 Divina3/DivinaMelange/Fjord/Harald  
 Full Grain Leather  
 COM fabric 0,65mt  
 COM leather 0,50mq
AL  
Matt painted aluminium
 Flash/Byte  
 Eco Leather  
 Patina  
 Revive/Disco Coex  
 Field  
 Umami/Canvas/Steelcut/Recheck/Glow  
 Divina3/DivinaMelange/Fjord/Harald  
 Full Grain Leather  
 COM fabric 0,65mt  
 COM leather 0,50mq

 **1 PCS**  
 9,8 Kg / A= 59 cm / B=64 cm / h=87 cm

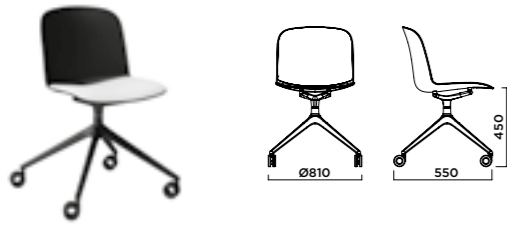
**RELIEF**  
 SWIVEL WITH CASTORS  
 UPHOLSTERED SEAT

Frame
Upholstery

 AL  
 Polished aluminium

 Flash/Byte  
 Eco Leather  
 Patina  
 Revive/Disco Coex  
 Field  
 Umami/Canvas/Steelcut/Recheck/Glow  
 Divina3/DivinaMelange/Fjord/Harald  
 Full Grain Leather  
 COM fabric 0,65mt  
 COM leather 0,50mq

 AL  
 Matt painted aluminium

 Flash/Byte  
 Eco Leather  
 Patina  
 Revive/Disco Coex  
 Field  
 Umami/Canvas/Steelcut/Recheck/Glow  
 Divina3/DivinaMelange/Fjord/Harald  
 Full Grain Leather  
 COM fabric 0,65mt  
 COM leather 0,50mq

 1 PCS  
 9,5 Kg / A= 63 cm / B=59 cm / h=86 cm

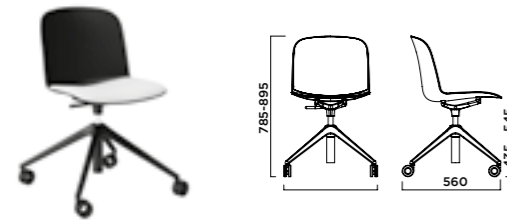
**RELIEF**  
 4 STAR UPDOWN UPHOLSTERED SEAT

Frame
Upholstery

 AL  
 Polished aluminium

 Flash/Byte  
 Eco Leather  
 Patina  
 Revive/Disco Coex  
 Field  
 Umami/Canvas/Steelcut/Recheck/Glow  
 Divina3/DivinaMelange/Fjord/Harald  
 Full Grain Leather  
 COM fabric 0,65mt  
 COM leather 0,50mq

 AL  
 Matt painted aluminium

 Flash/Byte  
 Eco Leather  
 Patina  
 Revive/Disco Coex  
 Field  
 Umami/Canvas/Steelcut/Recheck/Glow  
 Divina3/DivinaMelange/Fjord/Harald  
 Full Grain Leather  
 COM fabric 0,65mt  
 COM leather 0,50mq

 1 PCS  
 10,6 Kg / A= 63 cm / B=59 cm / h=86 cm

**RELIEF**  
 WOODEN LEGS UPHOLSTERED SEAT

Frame
Back
Upholstery

 MAFR  
 Solid ash

 PP  
 Polypropylene

 MAFR  
 Stained ash

 PP  
 Polypropylene

 Flash/Byte  
 Eco Leather  
 Patina  
 Revive/Disco Coex  
 Field  
 Umami/Canvas/Steelcut/Recheck/Glow  
 Divina3/DivinaMelange/Fjord/Harald  
 Full Grain Leather  
 COM fabric 0,65mt  
 COM leather 0,50mq

 Flash/Byte  
 Eco Leather  
 Patina  
 Revive/Disco Coex  
 Field  
 Umami/Canvas/Steelcut/Recheck/Glow  
 Divina3/DivinaMelange/Fjord/Harald  
 Full Grain Leather  
 COM fabric 0,65mt  
 COM leather 0,50mq

 1 PCS  
 8,5 Kg / A= 47,5 cm / B=58 cm / h=83 cm

**RELIEF**  
 WOODEN LEGS WITH ARMS  
 UPHOLSTERED SEAT

Frame
Back
Upholstery

 MAFR  
 Solid ash

 AC  
 Matt painted steel

 MAFR  
 Stained ash

 AC  
 Chromium-plated steel

 Flash/Byte  
 Eco Leather  
 Patina  
 Revive/Disco Coex  
 Field  
 Umami/Canvas/Steelcut/Recheck/Glow  
 Divina3/DivinaMelange/Fjord/Harald  
 Full Grain Leather  
 COM fabric 0,65mt  
 COM leather 0,50mq

 Flash/Byte  
 Eco Leather  
 Patina  
 Revive/Disco Coex  
 Field  
 Umami/Canvas/Steelcut/Recheck/Glow  
 Divina3/DivinaMelange/Fjord/Harald  
 Full Grain Leather  
 COM fabric 0,65mt  
 COM leather 0,50mq

 1 PCS  
 9,5 Kg / A= 63 cm / B=57 cm / h=83 cm

**RELIEF**  
 4 LEGS UPHOLSTERED  
 SEAT AND BACKREST PANEL

Frame

Upholstery

**AC**  
 Matt painted steel

 Flash/Byte  
 Eco Leather  
 Patina  
 Revive/Disco Coex  
 Field  
 Umami/Canvas/Steelcut/Recheck/Glow  
 Divina3/DivinaMelange/Fjord/Harald  
 Full Grain Leather  
 COM fabric 0,65mt  
 COM leather 1,00mq

**AC**  
 Chromium-plated steel

 Flash/Byte  
 Eco Leather  
 Patina  
 Revive/Disco Coex  
 Field  
 Umami/Canvas/Steelcut/Recheck/Glow  
 Divina3/DivinaMelange/Fjord/Harald  
 Full Grain Leather  
 COM fabric 0,65mt  
 COM leather 1,00mq

**2 PCS**  
 12 Kg / A= 53,5 cm / B=59 cm / h=89 cm

<sup>2</sup>
**RELIEF**  
 4 LEGS WITH ARMS  
 UPHOLSTERED SEAT AND BACKREST PANEL

Frame

Upholstery

**AC**  
 Matt painted steel

 Flash/Byte  
 Eco Leather  
 Patina  
 Revive/Disco Coex  
 Field  
 Umami/Canvas/Steelcut/Recheck/Glow  
 Divina3/DivinaMelange/Fjord/Harald  
 Full Grain Leather  
 COM fabric 0,65mt  
 COM leather 1,00mq

**AC**  
 Chromium-plated steel

 Flash/Byte  
 Eco Leather  
 Patina  
 Revive/Disco Coex  
 Field  
 Umami/Canvas/Steelcut/Recheck/Glow  
 Divina3/DivinaMelange/Fjord/Harald  
 Full Grain Leather  
 COM fabric 0,65mt  
 COM leather 1,00mq

**2 PCS**  
 13,5 Kg / A= 59 cm / B=64 cm / h=97,5 cm

<sup>2</sup>
**RELIEF**  
 SLED UPHOLSTERED  
 SEAT AND BACKREST PANEL

Frame

Upholstery

**AC**  
 Matt painted steel

 Flash/Byte  
 Eco Leather  
 Patina  
 Revive/Disco Coex  
 Field  
 Umami/Canvas/Steelcut/Recheck/Glow  
 Divina3/DivinaMelange/Fjord/Harald  
 Full Grain Leather  
 COM fabric 0,65mt  
 COM leather 1,00mq

**AC**  
 Chromium-plated steel

 Flash/Byte  
 Eco Leather  
 Patina  
 Revive/Disco Coex  
 Field  
 Umami/Canvas/Steelcut/Recheck/Glow  
 Divina3/DivinaMelange/Fjord/Harald  
 Full Grain Leather  
 COM fabric 0,65mt  
 COM leather 1,00mq

**2 PCS**  
 14,5 Kg / A= 64 cm / B=60 cm / h=97 cm

<sup>2</sup>
**RELIEF**  
 4 STAR ALUMINIUM BASE  
 UPHOLSTERED SEAT AND BACKREST PANEL

Frame

Upholstery

**AL**  
 Polished aluminium

 Flash/Byte  
 Eco Leather  
 Patina  
 Revive/Disco Coex  
 Field  
 Umami/Canvas/Steelcut/Recheck/Glow  
 Divina3/DivinaMelange/Fjord/Harald  
 Full Grain Leather  
 COM fabric 0,65mt  
 COM leather 1,00mq

**AL**  
 Matt painted aluminium

 Flash/Byte  
 Eco Leather  
 Patina  
 Revive/Disco Coex  
 Field  
 Umami/Canvas/Steelcut/Recheck/Glow  
 Divina3/DivinaMelange/Fjord/Harald  
 Full Grain Leather  
 COM fabric 0,65mt  
 COM leather 1,00mq

**1 PCS**  
 9,8 Kg / A= 59 cm / B=64 cm / h=87 cm

**RELIEF**  
 SWIVEL WITH CASTORS  
 UPHOLSTERED SEAT AND BACKREST PANEL

h Frame	h Upholstery
AL Polished aluminium	Flash/Byte Eco Leather Patina Revive/Disco Coex Field
	Umami/Canvas/Steelcut/Recheck/Glow Divina3/DivinaMelange/Fjord/Harald Full Grain Leather COM fabric 0,65mt COM leather 1,00mq
AL Matt painted aluminium	Flash/Byte Eco Leather Patina Revive/Disco Coex Field
	Umami/Canvas/Steelcut/Recheck/Glow Divina3/DivinaMelange/Fjord/Harald Full Grain Leather COM fabric 0,65mt COM leather 1,00mq

 **1 PCS**  
 9,5 Kg / A= 63 cm / B=59 cm / h=86 cm

**RELIEF**  
 WOODEN LEGS  
 UPHOLSTERED SEAT AND BACKREST PANEL

h Frame	h Upholstery
MAFR Solid ash	Flash/Byte Eco Leather Patina Revive/Disco Coex Field
	Umami/Canvas/Steelcut/Recheck/Glow Divina3/DivinaMelange/Fjord/Harald Full Grain Leather COM fabric 0,65mt COM leather 1,00mq
MAFR Stained ash	Flash/Byte Eco Leather Patina Revive/Disco Coex Field
	Umami/Canvas/Steelcut/Recheck/Glow Divina3/DivinaMelange/Fjord/Harald Full Grain Leather COM fabric 0,65mt COM leather 1,00mq

 **1 PCS**  
 8,5 Kg / A= 47,5 cm / B=58 cm / h=83 cm

**RELIEF**  
 4 STAR UPDOWN UPHOLSTERED SEAT  
 AND BACKREST PANEL

h Frame	h Upholstery
AL Polished aluminium	Flash/Byte Eco Leather Patina Revive/Disco Coex Field
	Umami/Canvas/Steelcut/Recheck/Glow Divina3/DivinaMelange/Fjord/Harald Full Grain Leather COM fabric 0,65mt COM leather 1,00mq
AL Matt painted aluminium	Flash/Byte Eco Leather Patina Revive/Disco Coex Field
	Umami/Canvas/Steelcut/Recheck/Glow Divina3/DivinaMelange/Fjord/Harald Full Grain Leather COM fabric 0,65mt COM leather 1,00mq

 **1 PCS**  
 10,6 Kg / A= 63 cm / B=59 cm / h=86 cm

**RELIEF**  
 WOODEN LEGS WITH ARMS  
 UPHOLSTERED SEAT AND BACKREST PANEL

h Frame	h Upholstery
MAFR Solid ash	Flash/Byte Eco Leather Patina Revive/Disco Coex Field
	Umami/Canvas/Steelcut/Recheck/Glow Divina3/DivinaMelange/Fjord/Harald Full Grain Leather COM fabric 0,65mt COM leather 1,00mq
MAFR Stained ash	Flash/Byte Eco Leather Patina Revive/Disco Coex Field
	Umami/Canvas/Steelcut/Recheck/Glow Divina3/DivinaMelange/Fjord/Harald Full Grain Leather COM fabric 0,65mt COM leather 1,00mq

 **1 PCS**  
 9,5 Kg / A= 63 cm / B=57 cm / h=83 cm

**RELIEF**  
 4 LEGS FULLY UPHOLSTERED

Frame

Upholstery

**AC**  
 Matt painted steel

 Flash/Byte  
 Eco Leather  
 Patina  
 Revive/Disco Coex  
 Field  
 Umami/Canvas/Steelcut/Recheck/Glow  
 Divina3/DivinaMelange/Fjord/Harald  
 Full Grain Leather  
 COM fabric 100mt  
 COM leather 140mq

**AC**  
 Chromium-plated steel

 Flash/Byte  
 Eco Leather  
 Patina  
 Revive/Disco Coex  
 Field  
 Umami/Canvas/Steelcut/Recheck/Glow  
 Divina3/DivinaMelange/Fjord/Harald  
 Full Grain Leather  
 COM fabric 100mt  
 COM leather 140mq

**2 PCS**  
 12 Kg / A= 53,5 cm / B=59 cm / h=89 cm

<sup>2</sup>
**RELIEF**  
 4 LEGS WITH ARMS  
 FULLY UPHOLSTERED

Frame

Upholstery

**AC**  
 Matt painted steel

 Flash/Byte  
 Eco Leather  
 Patina  
 Revive/Disco Coex  
 Field  
 Umami/Canvas/Steelcut/Recheck/Glow  
 Divina3/DivinaMelange/Fjord/Harald  
 Full Grain Leather  
 COM fabric 100mt  
 COM leather 140mq

**AC**  
 Chromium-plated steel

 Flash/Byte  
 Eco Leather  
 Patina  
 Revive/Disco Coex  
 Field  
 Umami/Canvas/Steelcut/Recheck/Glow  
 Divina3/DivinaMelange/Fjord/Harald  
 Full Grain Leather  
 COM fabric 100mt  
 COM leather 140mq

**2 PCS**  
 13,5 Kg / A= 59 cm / B=64 cm / h=97,5 cm

<sup>2</sup>
**RELIEF**  
 SLED FULLY UPHOLSTERED

Frame

Upholstery

**AC**  
 Matt painted steel

 Flash/Byte  
 Eco Leather  
 Patina  
 Revive/Disco Coex  
 Field  
 Umami/Canvas/Steelcut/Recheck/Glow  
 Divina3/DivinaMelange/Fjord/Harald  
 Full Grain Leather  
 COM fabric 100mt  
 COM leather 140mq

**AC**  
 Chromium-plated steel

 Flash/Byte  
 Eco Leather  
 Patina  
 Revive/Disco Coex  
 Field  
 Umami/Canvas/Steelcut/Recheck/Glow  
 Divina3/DivinaMelange/Fjord/Harald  
 Full Grain Leather  
 COM fabric 100mt  
 COM leather 140mq

**2 PCS**  
 14,5 Kg / A= 64 cm / B=60 cm / h=97 cm

<sup>2</sup>
**RELIEF**  
 4 STAR ALUMINIUM BASE  
 FULLY UPHOLSTERED

Frame

Upholstery

**AL**  
 Polished aluminium

 Flash/Byte  
 Eco Leather  
 Patina  
 Revive/Disco Coex  
 Field  
 Umami/Canvas/Steelcut/Recheck/Glow  
 Divina3/DivinaMelange/Fjord/Harald  
 Full Grain Leather  
 COM fabric 100mt  
 COM leather 140mq

**AL**  
 Matt painted aluminium

 Flash/Byte  
 Eco Leather  
 Patina  
 Revive/Disco Coex  
 Field  
 Umami/Canvas/Steelcut/Recheck/Glow  
 Divina3/DivinaMelange/Fjord/Harald  
 Full Grain Leather  
 COM fabric 100mt  
 COM leather 140mq

**1 PCS**  
 9,8 Kg / A= 59 cm / B=64 cm / h=87 cm

**RELIEF**  
 SWIVEL WITH CASTORS  
 FULLY UPHOLSTERED

h Frame	h Upholstery
AL Polished aluminium	Flash/Byte Eco Leather Patina Revive/Disco Coex Field
	Umami/Canvas/Steelcut/Recheck/Glow Divina3/DivinaMelange/Fjord/Harald Full Grain Leather COM fabric 1,00mt COM leather 1,40mq
AL Matt painted aluminium	Flash/Byte Eco Leather Patina Revive/Disco Coex Field
	Umami/Canvas/Steelcut/Recheck/Glow Divina3/DivinaMelange/Fjord/Harald Full Grain Leather COM fabric 1,00mt COM leather 1,40mq

 **1 PCS**  
 9,5 Kg / A= 63 cm / B=59 cm / h=86 cm

**RELIEF**  
 WOODEN LEGS FULLY UPHOLSTERED

h Frame	h Upholstery
MAFR Solid ash	Flash/Byte Eco Leather Patina Revive/Disco Coex Field
	Umami/Canvas/Steelcut/Recheck/Glow Divina3/DivinaMelange/Fjord/Harald Full Grain Leather COM fabric 1,00mt COM leather 1,40mq
MAFR Stained ash	Flash/Byte Eco Leather Patina Revive/Disco Coex Field
	Umami/Canvas/Steelcut/Recheck/Glow Divina3/DivinaMelange/Fjord/Harald Full Grain Leather COM fabric 1,00mt COM leather 1,40mq

 **1 PCS**  
 8,5 Kg / A= 47,5 cm / B=58 cm / h=83 cm

**RELIEF**  
 4 STAR UPDOWN  
 FULLY UPHOLSTERED

h Frame	h Upholstery
AL Polished aluminium	Flash/Byte Eco Leather Patina Revive/Disco Coex Field
	Umami/Canvas/Steelcut/Recheck/Glow Divina3/DivinaMelange/Fjord/Harald Full Grain Leather COM fabric 1,00mt COM leather 1,40mq
AL Matt painted aluminium	Flash/Byte Eco Leather Patina Revive/Disco Coex Field
	Umami/Canvas/Steelcut/Recheck/Glow Divina3/DivinaMelange/Fjord/Harald Full Grain Leather COM fabric 1,00mt COM leather 1,40mq

 **1 PCS**  
 10,6 Kg / A= 63 cm / B=59 cm / h=86 cm

**RELIEF**  
 WOODEN LEGS WITH ARMS  
 FULLY UPHOLSTERED

h Frame	h Upholstery
MAFR Solid ash	Flash/Byte Eco Leather Patina Revive/Disco Coex Field
	Umami/Canvas/Steelcut/Recheck/Glow Divina3/DivinaMelange/Fjord/Harald Full Grain Leather COM fabric 1,00mt COM leather 1,40mq
MAFR Stained ash	Flash/Byte Eco Leather Patina Revive/Disco Coex Field
	Umami/Canvas/Steelcut/Recheck/Glow Divina3/DivinaMelange/Fjord/Harald Full Grain Leather COM fabric 1,00mt COM leather 1,40mq

 **1 PCS**  
 9,5 Kg / A= 63 cm / B=57 cm / h=83 cm





**RELIEF 4 STAR ALUMINIUM BASE**

FRAME

**AL30**  
White matt painted

UPHOLSTERY

**CV654**  
Canvas Kvadrat

UPHOLSTERY

**CV614**  
Canvas Kvadrat

**RELIEF SLED**

FRAME

**AC30**  
White matt painted

UPHOLSTERY

**CV654**  
Canvas Kvadrat

UPHOLSTERY

**CV614**  
Canvas Kvadrat

# HARMO

DESIGN:

**BROGLIATOTRAVERSO**

THREE NEW LACQUERED FINISHES DRESS THE HARMO BEECH FRAME WITH A NEW LIGHT. OPAQUE AND GLOSSY, THE COLORS BROADEN THE PALETTE OF THE NORDIC-INSPIRED CHAIR, ALSO AVAILABLE IN A STOOL VERSION.

**NEW FINISHES**





FRAME  
MAF24  
Black laquered beech

FRAME

SOLID BEECH



MAF24  
Black laquered beech



MAF25  
Grey laquered beech



MAF26  
Green laquered beech

UPHOLSTERY AVAILABLE

FULL-GRAIN LEATHER ECO LEATHER  
76% PVC, 2% PU, 22% PES

REVIVE 1 Kvadrat  
100% PE FR ric.

UMAMI Kvadrat  
90% WO, 10% PA

PATINA Camira  
69% WO, 22% FL, 8% PO, 1% VI

FIELD Kvadrat  
100% TREVIRA

CAVA 3 Kvadrat  
90% WO, 10% PA

CANVAS Kvadrat  
90% WO, 10% PA

HARALD Kvadrat  
100% WO

DIVINA 3 Kvadrat  
100% WO

RECHECK Kvadrat  
90% WO, 10% NY

FLASH No-Shrink  
100% PP

DIVINA MELANGE 2 Kvadrat  
100% WO

FIORD Kvadrat  
92% WO, 8% NY

STEELCUT 3 Kvadrat  
90% WO, 10% PA

GLOW Kvadrat  
90% WO, 10% NY

BYTE  
100% PL

HARMO  
CHAIR

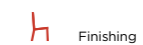
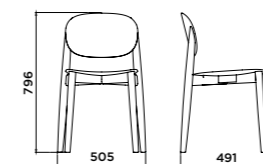

Finishing

MAF  
Laquered solid beech

2 PC  
12 Kg / A= 50 cm / B= 50,5 cm / h= 79,6 cm



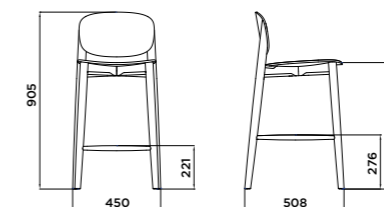

HARMO  
KITCHEN STOOL



Finishing

MAF  
Laquered solid beech

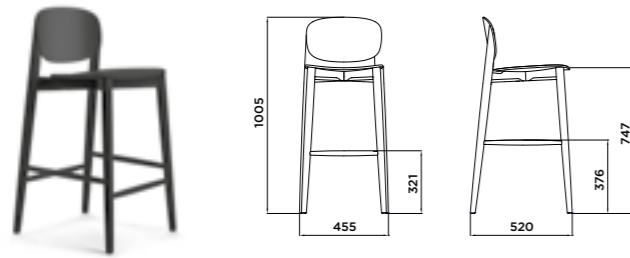
1 PC  
9 Kg / A= 58 cm / B= 58 cm / h= 79 cm

**HARMO**  
BAR STOOL FinishingMAF  
Laquered solid beech
 1 PC  
9,4 Kg / A= 58 cm / B= 58 cm / h= 89 cm
**HARMO**  
BAR STOOL UPHOLSTERED Frame UpholsteryMAFR  
Laquered solid beech

Flash/Byte  
Eco Leather  
Patina  
Revive  
Field/Cava  
Umami/Canvas/Steelcut/Recheck/Glow  
Divina3/DivinaMelange/Fjord/Harald  
Full Grain Leather  
COM fabric 0,60mt  
COM leather 1,20mq

 1 PC  
9,4 Kg / A= 58 cm / B= 58 cm / h= 89 cm
**HARMO**  
UPHOLSTERED Frame UpholsteryMAF  
Laquered solid beech

Flash/Byte  
Eco Leather  
Patina  
Revive  
Field/Cava  
Umami/Canvas/Steelcut/Recheck/Glow  
Divina3/DivinaMelange/Fjord/Harald  
Full Grain Leather  
COM fabric 0,60mt  
COM leather 1,20mq

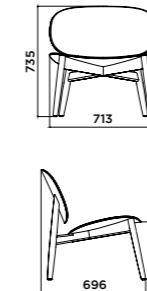
 2 PC  
12 Kg / A= 50 cm / B= 50,5 cm / h= 79,6 cm
 2**HARMO**  
RELAX Frame UpholsteryMAF  
Laquered solid beech

Flash/Byte  
Eco Leather  
Patina  
Revive  
Field/Cava  
Umami/Canvas/Steelcut/Recheck/Glow  
Divina3/DivinaMelange/Fjord/Harald  
Full Grain Leather  
COM fabric 1,70mt  
COM leather 3,20mq

 1 PC  
12 Kg / A= 81 cm / B= 82 cm / h= 90 cm
**HARMO**  
KITCHEN STOOL UPHOLSTERED Frame UpholsteryMAF  
Laquered solid beech

Flash/Byte  
Eco Leather  
Patina  
Revive  
Field/Cava  
Umami/Canvas/Steelcut/Recheck/Glow  
Divina3/DivinaMelange/Fjord/Harald  
Full Grain Leather  
COM fabric 0,60mt  
COM leather 1,20mq

 1 PC  
9 Kg / A= 58 cm / B= 58 cm / h= 79 cm



FRAME  
MAF26  
Green laquered beech

# RUELLE

DESIGN:

**PHILIPPE TABET**

RUELLE SHOWS OFF IN A BRAND NEW VERSION: THE POLYPROPYLENE OR PLYWOOD BACKREST MATCHES WITH A DELICATE NUDE ALUMINUM BODY WITH CONTRASTING LEGS. THE RESULT IS A DISTINCTIVE INDUSTRIAL MOOD, MAKING THIS CHAIR PERFECT FOR CONTEMPORARY RESTAURANTS, BARS AND BISTROS.

**NEW FINISHES**





ALUMINUM IS MANUFACTURED IN TWO DIFFERENT PROCESSES: THE LEGS ARE IN ANODISED EXTRUDED ALUMINUM, WHILE THE SEAT AND BACKREST SUPPORTS ARE IN DIE-CAST ALUMINUM.

FRAME

AL60  
Nude aluminium

BACKREST

LR08  
Black painted oak



FRAME

NUDE ALUMINIUM



AL60  
Nude aluminium

BACKREST

POLYPROPYLENE



PP20  
White



PP7608U  
Marsala



PP32  
Slate grey



PP21  
Pearl grey



PP503  
Powder blue

PLYWOOD OAK



LR03  
Natural oak



LR08  
Black stained oak

UPHOLSTERY AVAILABLE

FULL-GRAIN LEATHER

ECO LEATHER  
76% PVC, 2% PU, 22% PES

REVIVE 1 Kvadrat  
100% PE FR ric.

FIELD Kvadrat  
100% TREVIRA

CANVAS Kvadrat  
90% WO, 10% PA

DIVINA 3 Kvadrat  
100% WO

DIVINA MELANGE 2 Kvadrat  
100% WO

STEELCUT 3 Kvadrat  
90% WO, 10% PA

UMAMI Kvadrat  
90% WO, 10% PA

CAVA 3 Kvadrat  
90% WO, 10% PA

HARALD Kvadrat  
100% WO

RECHECK Kvadrat  
90% WO, 10% NY

FIORD Kvadrat  
92% WO, 8% NY

GLOW Kvadrat  
90% WO, 10% NY

PATINA Camira  
69% WO, 22% FL, 8% PQ, 1% VI

FLASH No-Shrink  
100% PP

BYTE  
100% PL

DISCO COEX by Chioccarello  
70% CO, 20% AC, 5% VI, 5% LI

RUELLE NUDE ALUMINIUM  
PLASTIC BACKREST

h Frame

h Backrest

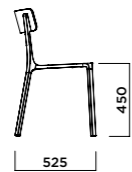
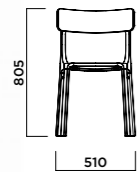

AL  
Nude aluminium

PP  
Polypropylene

2 PC  
13,9 Kg / A= 52,5 cm / B= 60cm / h= 87,5cm



RUELLE NUDE ALUMINIUM  
WOODEN BACKREST

h Frame

h Backrest

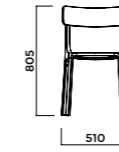

AL  
Nude aluminium

LR  
Natural oak

LR  
Stained oak

2 PC  
13,9 Kg / A= 52,5 cm / B= 60cm / h= 87,5cm



RUELLE NUDE ALUMINIUM  
PLASTIC BACKREST  
UPHOLSTERED PANEL

h Frame

h Backrest

h Upholstery



AL  
Nude aluminium

PP  
Polypropylene

Flash/Byte  
Eco Leather  
Patina  
Revive/Disco Coex  
Field/Cava  
Umami/Canvas/Steelcut/Recheck/Glow  
Divina3/DivinaMelange/Fiord/Harald  
Full Grain Leather  
COM fabric 0,60mt  
COM leather 0,70mq

2 PC  
13,9 Kg / A= 52,5 cm / B= 60cm / h= 87,5cm



RUELLE NUDE ALUMINIUM  
WOODEN BACKREST  
UPHOLSTERED PANEL

h Frame

h Backrest

h Upholstery



AL  
Nude aluminium

LR  
Stained oak

Flash/Byte  
Eco Leather  
Patina  
Revive/Disco Coex  
Field/Cava  
Umami/Canvas/Steelcut/Recheck/Glow  
Divina3/DivinaMelange/Fiord/Harald  
Full Grain Leather  
COM fabric 0,60mt  
COM leather 0,70mq

2 PC  
13,9 Kg / A= 52,5 cm / B= 60cm / h= 87,5cm







FRAME  
AL60  
Nude aluminium

BACKREST  
LR08  
Black painted oak

# TONDINA POP

DESIGN:

**FAVARETTO&PARTNERS**

A NEW FRAME FINISH IS ADDED TO THE ICONIC TONDINA: ANTIQUE BRASS MATCHES PERFECTLY WITH REFINED UPHOLSTERY BUT CREATES ALSO A MODERN CONTRAST IN THE POP VERSION WITH POLYPROPYLENE SEAT AND BACKREST. DECLINED IN CHAIR AND STOOL VERSION, TONDINA IS PERFECT FOR RESTAURANTS, BARS AND CAFETERIAS.

NEW FINISHES





FRAME  
AC14  
Antique brass

UPHOLSTERY  
PT24  
Patina



FRAME  
AC14  
Antique brass

UPHOLSTERY  
PT22  
Patina Camira

FRAME

STEEL



AC14  
Antique brass

SEAT AND BACKREST

POLYPROPYLENE



PP34  
Peach



PP31  
Coal black



PP7608U  
Marsala



PP557C  
Light teal



PP421C  
Almond grey



PP480C  
Cipria



PP20  
White

UPHOLSTERY AVAILABLE

FULL-GRAIN LEATHER

ECO LEATHER  
76% PVC, 2% PU, 22% PES

REVIVE 1 Kvadrat  
100% PE FR ric.

FIELD Kvadrat  
100% TREVIRA

CANVAS Kvadrat  
90% WO, 10% PA

DIVINA 3 Kvadrat  
100% WO

DIVINA MELANGE 2 Kvadrat  
100% WO

STEELCUT 3 Kvadrat  
90% WO, 10% PA

UMAMI Kvadrat  
90% WO, 10% PA

CAVA 3 Kvadrat  
90% WO, 10% PA

HARALD Kvadrat  
100% WO

RECHECK Kvadrat  
90% WO, 10% NY

FIORD Kvadrat  
92% WO, 8% NY

GLOW Kvadrat  
90% WO, 10% NY

PATINA Camira  
69% WO, 22% FL, 8% PQ, 1% VI

MIAMI Pintail  
88% PL, 12% PE

FLASH No-Shrink  
100% PP

BYTE  
100% PL

TONDINA POP  
4 LEGS

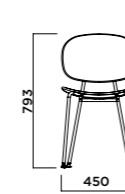
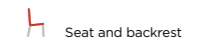

AC  
Antique brass

PP  
Polypropylene

2 PCS  
12,2 Kg / A= 47,5cm / B= 63cm / h= 85,5cm

TONDINA POP  
4 LEGS WITH ARMS

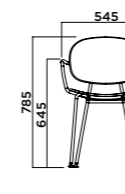
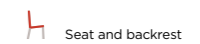

AC  
Antique brass

PP  
Polypropylene

2 PCS  
14,2 Kg / A= 57,5cm / B= 63cm / h= 87cm

**TONDINA POP**  
KITCHEN STOOL

Frame

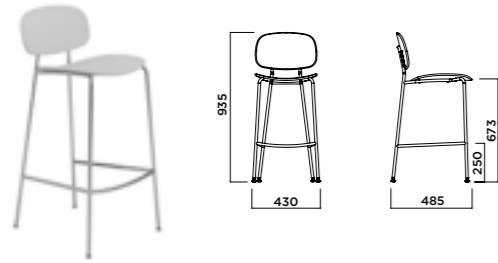

Seat and backrest

AC  
Antique brassPP  
Polypropylene 1 PC  
7,8 Kg / A= 57cm / B= 46cm / h= 98cm**TONDINA POP**  
BAR STOOL

Frame

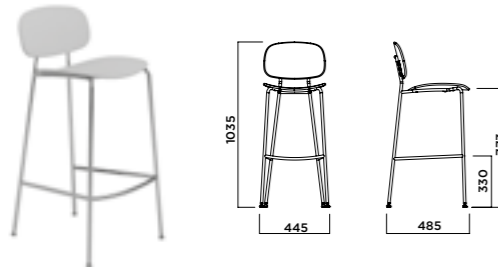

Seat and backrest

AC  
Antique brassPP  
Polypropylene 1 PC  
8,2 Kg / A= 57cm / B= 46cm / h= 109cm**TONDINA POP**  
4 LEGS UPHOLSTERED

Frame



Upholstery

AC  
Antique brassFlash/Byte  
Eco Leather  
Patina  
Revive  
Field/Cava  
Umami/Canvas/Steelcut/Recheck/Glow  
Divina3/DivinaMelange/Fjord/Harald  
Full Grain Leather  
COM fabric 0,90mt  
COM leather 1,20mq 2 PCS  
12,2 Kg / A= 47,5cm / B= 63cm / h= 85,5cm**TONDINA POP**  
4 LEGS WITH ARMS UPHOLSTERED

Frame



Upholstery

AC  
Antique brassFlash/Byte  
Eco Leather  
Patina  
Revive  
Field/Cava  
Umami/Canvas/Steelcut/Recheck/Glow  
Divina3/DivinaMelange/Fjord/Harald  
Full Grain Leather  
COM fabric 0,90mt  
COM leather 1,20mq 2 PCS  
14,2 Kg / A= 57,5cm / B= 63cm / h= 87cm**TONDINA POP**  
KITCHEN STOOL UPHOLSTERED

Frame



Upholstery

AC  
Antique brassFlash/Byte  
Eco Leather  
Patina  
Revive  
Field/Cava  
Umami/Canvas/Steelcut/Recheck/Glow  
Divina3/DivinaMelange/Fjord/Harald  
Full Grain Leather  
COM fabric 0,90mt  
COM leather 1,20mq 1 PC  
7,8 Kg / A= 57cm / B= 46cm / h= 98cm**TONDINA POP**  
BAR STOOL UPHOLSTERED

Frame



Upholstery

AC  
Antique brassFlash/Byte  
Eco Leather  
Patina  
Revive  
Field/Cava  
Umami/Canvas/Steelcut/Recheck/Glow  
Divina3/DivinaMelange/Fjord/Harald  
Full Grain Leather  
COM fabric 0,90mt  
COM leather 1,20mq 1 PC  
8,2 Kg / A= 57cm / B= 46cm / h= 109cm



**TONDINA POP WITH ARMS**  
 FRAME AC14  
 Antique brass

SEAT AND BACKRESTREST HA182  
 Harald Kvadrat

**TONDINA POP 4 LEGS**  
 FRAME AC14  
 Antique brass

SEAT AND BACKRESTREST GL873  
 Glow Kvadrat

# COOKIE

DESIGN:

**STUDIO ZETASS**

THIS COMFORTABLE AND SINUOUS ARMCHAIR WELCOMES TO THE RANGE THE FOUR LEG BASE IN CHROMED AND PAINTED STEEL.

**NEW FINISHES**





FRAME  
AC30  
White matt painted

SHELL  
CV614  
Canvas Kvadrat

FRAME

STEEL



AC01  
Chrome plated

AC30  
White matt painted

AC31  
Black matt painted

SHELL

POLYPROPYLENE



PP20  
White

PP503  
Powder blue

PP421C  
Almond

PP480C  
Cipria

PP11  
Anthracite

UPHOLSTERY AVAILABLE

FULL-GRAIN LEATHER

ECO LEATHER  
76% PVC, 2% PU, 22% PES

REVIVE 1 Kvadrat  
100% PE FR ric.

FIELD Kvadrat  
100% TREVIRA

HARALD Kvadrat  
100% WO

FLASH No-Shrink  
100% PP

STEELCUT 3 Kvadrat  
90% WO, 10% PA

UMAMI Kvadrat  
90% WO, 10% PA

CAVA 3 Kvadrat  
90% WO, 10% PA

DIVINA 3 Kvadrat  
100% WO

DIVINA MELANGE 2 Kvadrat  
100% WO

GLOW Kvadrat  
90% WO, 10% NY

PATINA Camira  
69% WO, 22% FL, 8% PO, 1% VI

CANVAS Kvadrat  
90% WO, 10% PA

RECHECK Kvadrat  
90% WO, 10% NY

FIORD Kvadrat  
92% WO, 8% NY

BYTE  
100% PL

COOKIE  
4 LEGS



Frame



Shell

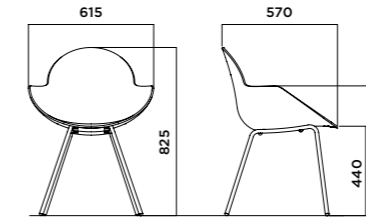

AC  
Matt painted steel

PP  
Polypropylene

AC  
Chromium-plated steel

PP  
Polypropylene



1 PC  
10,3 Kg / A= 59cm / B= 63cm / h= 85,5cm

COOKIE

4 LEGS UPHOLSTERED



Frame



Shell



AC  
Matt painted steel

Flash/Byte  
Eco Leather  
Patina  
Revive  
Field/Cava  
Umami/Canvas/Steelcut/Recheck/Glow  
Divina3/DivinaMelange/Fiord/Harald  
Full Grain Leather  
COM fabric 110mt  
COM leather 120mq

AC  
Chromium-plated steel

Flash/Byte  
Eco Leather  
Patina  
Revive  
Field/Cava  
Umami/Canvas/Steelcut/Recheck/Glow  
Divina3/DivinaMelange/Fiord/Harald  
Full Grain Leather  
COM fabric 110mt  
COM leather 170mq



1 PC  
10,3 Kg / A= 59cm / B= 63cm / h= 85,5cm



# ÚTI

DESIGN:

**mC.dsg** | ÚTI WIDENS THE RANGE WITH THE ADDITION OF THE POLYPROPYLENE BACK, SUITABLE FOR INDUSTRIAL STYLE ENVIRONMENTS OR FOR OUTDOOR AND VERANDA SETTINGS.

NEW FINISHES





FRAME  
AC40  
Lead grey  
fine textured

BACKREST  
PP421C  
Almond

FRAME

STEEL



AC46 Honey yellow fine textured  
AC47 Dove grey fine textured  
AC48 Grey beige fine textured  
AC40 Lead grey fine textured



AC41 Light grey fine textured  
AC44 White fine textured  
AC45 Oxide red fine textured

BACKREST

POLYPROPYLENE



PP421C Almond  
PP11 Anthracite  
PP20 White  
PP7608U Marsala



PP1012 Mustard  
PP22 Tobacco  
PP514 Sand

FELT SEAT PANEL

OPTIONAL ON REQUEST - Available with Miami Pintail

ÚTI  
PLASTIC BACK



Frame



Backrest

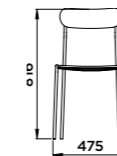

AC Steel

PP Polypropylene

2 PCS  
11,8 Kg / A= 55 cm / B= 56 cm / h= 84 cm



ÚTI  
PLASTIC BACK WITH ARMS



Frame



Backrest

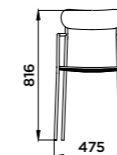

AC Steel

PP Polypropylene

2 PCS  
14 Kg / A= 55 cm / B= 56 cm / h= 84 cm





## FRAME

AC41  
Light grey  
fine textured

AC46  
Honey yellow  
fine textured

## BACKREST

PP421  
Almond

PP1012  
Mustard

# KRAM

DESIGN:

**THOMAS PEDERSEN**

THE ELEGANT NORDIC SEAT, WITH ITS WITH ITS SHAPE REMINDING OF AN OPEN SHELL, IS PRESENTED IN A COMFORTABLE AND ELEGANT VERSION, WITH BEAUTIFULLY UPHOLSTERED SEAT AND BACKREST.

**NEW FINISHES**





SEAT AND BACKREST  
LR08  
Black stained oak

UPHOLSTERY  
HA182  
Harald Kvadrat

FRAME

STEEL



AC01 Chrome plated  
AC30 White matt painted  
AC31 Black matt painted  
AC12 Black chrome plated  
AC13 Copper plated

SEAT AND BACKREST

PLYWOOD OAK



LV06 Stratus Superior American Walnut  
LR03 Natural oak  
LR08 Black stained oak

UPHOLSTERY AVAILABLE

HARALD Kvadrat 100% WO  
GLOW Kvadrat 90% WO, 10% NY  
STEELCUT 3 Kvadrat 90% WO, 10% PA  
FULL-GRAIN LEATHER

KRAM  
STEEL FRAME

h Frame h Seat and backrest h Upholstery

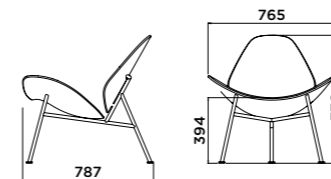

Frame	Seat and backrest	Upholstery
AC Matt painted steel	LR Natural oak	Steelcut/Glow Field/Harald Full Grain Leather COM fabric 170mt COM leather 2,00mq
	LR Black stained oak	Steelcut/Glow Field/Harald Full Grain Leather COM fabric 170mt COM leather 2,00mq
	LV Stratus Superior American Walnut	Steelcut/Glow Field/Harald Full Grain Leather COM fabric 170mt COM leather 2,00mq
AC Chromium-plated steel	LR Natural oak	Steelcut/Glow Field/Harald Full Grain Leather COM fabric 170mt COM leather 2,00mq
	LR Black stained oak	Steelcut/Glow Field/Harald Full Grain Leather COM fabric 170mt COM leather 2,00mq
	LV Stratus Superior American Walnut	Steelcut/Glow Field/Harald Full Grain Leather COM fabric 170mt COM leather 2,00mq
	LR Natural oak	Steelcut/Glow Field/Harald Full Grain Leather COM fabric 170mt COM leather 2,00mq
AC Coloured chromium-plated steel	LR Black stained oak	Steelcut/Glow Field/Harald Full Grain Leather COM fabric 170mt COM leather 2,00mq
	LV Stratus Superior American Walnut	Steelcut/Glow Field/Harald Full Grain Leather COM fabric 170mt COM leather 2,00mq

1 PC  
11,4 Kg / A= 81 cm / B= 81 cm /h= 89,5 cm





**KRAM**  
SEAT AND BACKREST  
LR08  
Black stained oak

UPHOLSTERY  
HA182  
Harald Kvadrat

**DIAPASON TABLE**  
BASE | TABLE TOP  
AC31 | LM02  
Black | Black

# PEB

DESIGN:

## BROGLIATOTRAVERSO

PEB IS ENRICHED BY THE 4-LEG WOODEN BASE, WHICH MAKES IT THE IDEAL ARMCHAIR FOR WAITING ROOMS AND LOUNGES. AVAILABLE BOTH IN LOW AND HIGH BACK VERSIONS

NEW FINISHES





FRAME  
MAFR01  
Natural ash

UPHOLSTERY  
SIT F0271  
BACKREST F0101  
Fiord Kvadrat

FRAME

SOLID ASH



MAFR01  
Natural ash

LFR08  
Black stained ash

ALUMINIUM



AL07  
Polished

AL30  
White matt painted

AL31  
Black matt painted

STEEL



AC01  
Chrome plated

AC30  
White matt painted

AC31  
Black matt painted

UPHOLSTERY AVAILABLE

FULL-GRAIN LEATHER

REVIVE 1 Kvadrat  
100% PE FR ric.

UMAMI Kvadrat  
90% WO, 10% PA

PATINA Camira  
69% WO, 22% FL, 8% PQ, 1% VI

ECO LEATHER

76% PVC, 2% PU, 22% PES

FIELD Kvadrat  
100% TREVIRA

CAVA 3 Kvadrat  
90% WO, 10% PA

CANVAS Kvadrat  
90% WO, 10% PA

HARALD Kvadrat  
100% WO

DIVINA 3 Kvadrat  
100% WO

RECHECK Kvadrat  
90% WO, 10% NY

FLASH No-Shrink  
100% PP

DIVINA MELANGE 2 Kvadrat  
100% WO

FIORD Kvadrat  
92% WO, 8% NY

STEELCUT 3 Kvadrat  
90% WO, 10% PA

GLOW Kvadrat  
90% WO, 10% NY

BYTE  
100% PL

PEB  
WOODEN LEGS LOW BACK

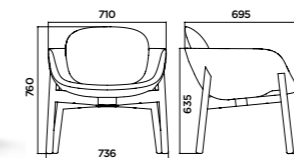

MAFR  
Solid ash

Flash/Byte  
Eco Leather  
Patina  
Revive  
Field  
Umami/Canvas/Steelcut/Recheck/Glow  
Divina3/DivinaMelange/Fiord/Harald  
Full Grain Leather  
COM fabric seat 1,70mt - back 0,65mt  
COM leather seat 2,30mq - back 1,2mq

MAFR  
Black stained ash

Flash/Byte  
Eco Leather  
Patina  
Revive  
Field  
Umami/Canvas/Steelcut/Recheck/Glow  
Divina3/DivinaMelange/Fiord/Harald  
Full Grain Leather  
COM fabric seat 1,70mt - back 0,65mt  
COM leather seat 2,30mq - back 1,2mq

1 PC  
20,5 Kg / A= 74cm / B= 71cm / h= 74,5cm



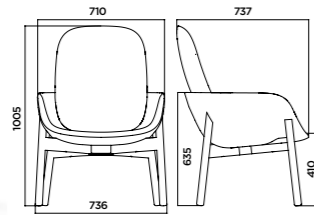

**PEB**  
 WOODEN LEGS HIGH BACK

**MAFR**  
 Solid ash

Flash/Byte  
 Eco Leather  
 Patina  
 Revive  
 Field  
 Umami/Canvas/Steelcut/Redcheck/Glow  
 Divina3/DivinaMelange/Fiord/Harald  
 Full Grain Leather  
 COM fabric seat 1,70mt - back 0,8mt  
 COM leather seat 2,30mq - back 1,55mq

**MAFR**  
 Black stained ash

Flash/Byte  
 Eco Leather  
 Patina  
 Revive  
 Field  
 Umami/Canvas/Steelcut/Redcheck/Glow  
 Divina3/DivinaMelange/Fiord/Harald  
 Full Grain Leather  
 COM fabric seat 1,70mt - back 0,8mt  
 COM leather seat 2,30mq - back 1,55mq

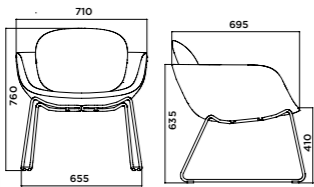
**1 PC**  
 24 Kg / A= 82cm / B= 83cm / h= 113cm

**PEB**  
 SLED LOW BACK

**AC**  
 Matt painted steel

Flash/Byte  
 Eco Leather  
 Patina  
 Revive  
 Field  
 Umami/Canvas/Steelcut/Redcheck/Glow  
 Divina3/DivinaMelange/Fiord/Harald  
 Full Grain Leather  
 COM fabric seat 1,70mt - back 0,65mt  
 COM leather seat 2,30mq - back 1,2mq

**AC**  
 Chromium-plated steel

Flash/Byte  
 Eco Leather  
 Patina  
 Revive  
 Field  
 Umami/Canvas/Steelcut/Redcheck/Glow  
 Divina3/DivinaMelange/Fiord/Harald  
 Full Grain Leather  
 COM fabric seat 1,70mt - back 0,65mt  
 COM leather seat 2,30mq - back 1,2mq

**1 PC**  
 19,2 Kg / A= 74cm / B= 71cm / h= 74,5cm

Frame

Upholstery

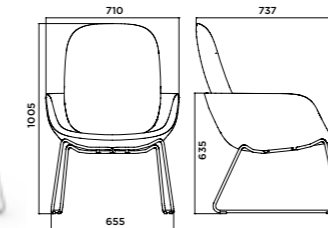
**PEB**  
 SLED HIGH BACK

**AC**  
 Matt painted steel

Flash/Byte  
 Eco Leather  
 Patina  
 Revive  
 Field  
 Umami/Canvas/Steelcut/Redcheck/Glow  
 Divina3/DivinaMelange/Fiord/Harald  
 Full Grain Leather  
 COM fabric seat 1,70mt - back 0,8mt  
 COM leather seat 2,30mq - back 1,55mq

**AC**  
 Chromium-plated steel

Flash/Byte  
 Eco Leather  
 Patina  
 Revive  
 Field  
 Umami/Canvas/Steelcut/Redcheck/Glow  
 Divina3/DivinaMelange/Fiord/Harald  
 Full Grain Leather  
 COM fabric seat 1,70mt - back 0,8mt  
 COM leather seat 2,30mq - back 1,55mq

**1 PC**  
 20,3 Kg / A= 82cm / B= 83cm / h= 113cm

Frame

Upholstery

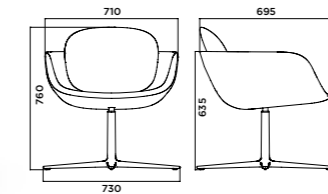
**PEB**  
 4 STAR LOW BACK

**AL**  
 Polished aluminium

Flash/Byte  
 Eco Leather  
 Patina  
 Revive  
 Field  
 Umami/Canvas/Steelcut/Redcheck/Glow  
 Divina3/DivinaMelange/Fiord/Harald  
 Full Grain Leather  
 COM fabric seat 1,70mt - back 0,65mt  
 COM leather seat 2,30mq - back 1,2mq

**AL**  
 Matt painted aluminium

Flash/Byte  
 Eco Leather  
 Patina  
 Revive  
 Field  
 Umami/Canvas/Steelcut/Redcheck/Glow  
 Divina3/DivinaMelange/Fiord/Harald  
 Full Grain Leather  
 COM fabric seat 1,70mt - back 0,65mt  
 COM leather seat 2,30mq - back 1,2mq

**1 PC**  
 22,2 Kg / A= 74cm / B= 71cm / h= 74,5cm

Base

Upholstery

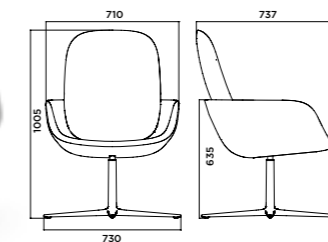
**PEB**  
 4 STAR HIGH BACK

**AL**  
 Polished aluminium

Flash/Byte  
 Eco Leather  
 Patina  
 Revive  
 Field  
 Umami/Canvas/Steelcut/Redcheck/Glow  
 Divina3/DivinaMelange/Fiord/Harald  
 Full Grain Leather  
 COM fabric seat 1,70mt - back 0,8mt  
 COM leather seat 2,30mq - back 1,55mq

**AL**  
 Matt painted aluminium

Flash/Byte  
 Eco Leather  
 Patina  
 Revive  
 Field  
 Umami/Canvas/Steelcut/Redcheck/Glow  
 Divina3/DivinaMelange/Fiord/Harald  
 Full Grain Leather  
 COM fabric seat 1,70mt - back 0,8mt  
 COM leather seat 2,30mq - back 1,55mq

**1 PC**  
 23,3 Kg / A= 82cm / B= 83cm / h= 113cm



## PEB LOW BACK

## FRAME

AC30  
White matt painted

## UPHOLSTERY

BACKREST CV424 Canvas Kvadrat  
SEAT RV524 Revive

## PEB HIGH BACK

## FRAME

AC30  
White matt painted

## UPHOLSTERY

BACKREST CV446 Canvas Kvadrat  
SEAT RV664 Revive

# KLEJN LOW

DESIGN:

**THOMAS PEDERSEN**

THE SIMPLEST BUT MOST REFINED OF THE STOOLS IS REINVENTED IN THE 45 CM HEIGHT VERSION, PERFECT FOR ALL CONTEXTS IN WHICH IT IS NECESSARY TO HAVE AN EXTRA SEAT AVAILABLE WITHOUT TAKING UP TOO MUCH SPACE. THE WIDE CHOICE OF FINISHES FOR THE BASES AND THE ENDLESS UPHOLSTERY OPTIONS MAKES KLEJN PERFECT FOR BOTH INTERIOR AND EXTERIOR SETTINGS.

**RANGE EXTENSION**



h 450mm



FRAME  
AC31  
Black matt painted

SEAT PANEL  
MAFR09  
Graphite black stained

FRAME

STEEL



AC30 White matt painted  
AC31 Black matt painted  
AC12 Black chrome plated  
AC13 Copper plated

SEAT PANEL

POLYPROPYLENE



PP20 White  
PP11 Anthracite  
PP503 Powder blue  
PP480C Cipria



PP31 Black coal  
PP7608U Marsala  
PP27 Curry

SOLID ASH



MAFR01 Natural ash  
MAFR09 Graphite black stained  
MAFR10 Basalt grey stained

UPHOLSTERY AVAILABLE

FULL-GRAIN LEATHER

ECO LEATHER  
76% PVC, 2% PU, 22% PES

REVIVE 1 Kvadrat 100% PE FR ric.	FIELD Kvadrat 100% TREVIRA	HARALD Kvadrat 100% WO	FLASH No-Shrink 100% PP	STEELCUT 3 Kvadrat 90% WO, 10% PA	UMAMI Kvadrat 90% WO, 10% PA
CAVA 3 Kvadrat 90% WO, 10% PA	DIVINA 3 Kvadrat 100% WO	DIVINA MELANGE 2 Kvadrat 100% WO	GLOW Kvadrat 90% WO, 10% NY	PATINA Camira 69% WO, 22% FL, 8% PO, 1% VI	CANVAS Kvadrat 90% WO, 10% PA
RECHECK Kvadrat 90% WO, 10% NY	FIORD Kvadrat 92% WO, 8% NY	BYTE 100% PL	DISCO COEX by Chioccarello 70% CO, 20% AC, 5% VI, 5% LI		

KLEJN LOW  
4 STAR HIGH BACK

KLEJN LOW  
POLYPROPYLENE PANEL

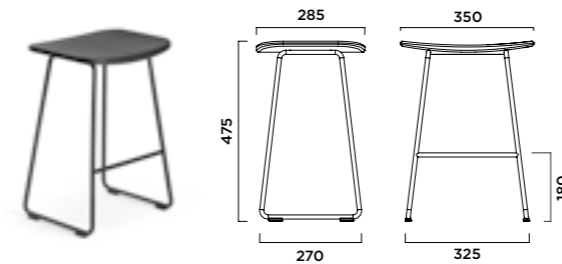

AC Matt painted steel  
PP Polypropylene

AC Coloured chromium-plated steel  
PP Polypropylene

AC Zinc/painted steel  
PP Polypropylene

1 PC  
4,8Kg / A= 30cm / B= 36cm / h= 50cm



**KLEJN LOW**  
 UPHOLSTERED PANEL

 Frame

 Seat panel

 Upholstery

**AC**  
 Matt painted steel

**PP**  
 Polypropylene

 Flash/Byte  
 Eco Leather  
 Patina  
 Revive/Disco Coex  
 Field  
 Umami/Canvas/Steelcut/Recheck/Glow  
 Divina3/DivinaMelange/Fiord/Harald  
 Full Grain Leather  
 COM fabric 0,50mt  
 COM leather 0,20mq

**AC**  
 Coloured  
 chromium-plated steel

**PP**  
 Polypropylene

 Flash/Byte  
 Eco Leather  
 Patina  
 Revive/Disco Coex  
 Field  
 Umami/Canvas/Steelcut/Recheck/Glow  
 Divina3/DivinaMelange/Fiord/Harald  
 Full Grain Leather  
 COM fabric 0,50mt  
 COM leather 0,20mq

 **1PC**  
 4,2Kg / A= 30cm / B= 36cm / h= 50cm

**KLEJN LOW**  
 WOOD UPHOLSTERED PANEL

 Frame

 Seat panel

 Upholstery

**AC**  
 Matt painted steel

**MAFR**  
 Natural ash/whitened

 Flash/Byte  
 Eco Leather  
 Patina  
 Revive/Disco Coex  
 Field  
 Umami/Canvas/Steelcut/Recheck/Glow  
 Divina3/DivinaMelange/Fiord/Harald  
 Full Grain Leather  
 COM fabric 0,50mt  
 COM leather 0,20mq

**AC**  
 Matt painted steel

**MAFR**  
 Stained ash

 Flash/Byte  
 Eco Leather  
 Patina  
 Revive/Disco Coex  
 Field  
 Umami/Canvas/Steelcut/Recheck/Glow  
 Divina3/DivinaMelange/Fiord/Harald  
 Full Grain Leather  
 COM fabric 0,50mt  
 COM leather 0,20mq

**AC**  
 Coloured  
 chromium-plated steel

**MAFR**  
 Natural ash/whitened

 Flash/Byte  
 Eco Leather  
 Patina  
 Revive/Disco Coex  
 Field  
 Umami/Canvas/Steelcut/Recheck/Glow  
 Divina3/DivinaMelange/Fiord/Harald  
 Full Grain Leather  
 COM fabric 0,50mt  
 COM leather 0,20mq

**AC**  
 Coloured  
 chromium-plated steel

**MAFR**  
 Stained ash

 Flash/Byte  
 Eco Leather  
 Patina  
 Revive/Disco Coex  
 Field  
 Umami/Canvas/Steelcut/Recheck/Glow  
 Divina3/DivinaMelange/Fiord/Harald  
 Full Grain Leather  
 COM fabric 0,50mt  
 COM leather 0,20mq

 **1PC**  
 6Kg / A= 37cm / B= 34cm / h= 67,5cm

**KLEJN LOW**  
 WOODEN PANEL

 Frame

 Seat panel

**AC**  
 Matt painted steel

**MAFR**  
 Natural ash/whitened

**AC**  
 Matt painted steel

**MAFR**  
 Stained ash

**AC**  
 Coloured  
 chromium-plated steel

**MAFR**  
 Natural ash/whitened

**AC**  
 Coloured  
 chromium-plated steel

**MAFR**  
 Stained ash

 **1PC**  
 4,8Kg / A= 30cm / B= 36cm / h= 50cm



<i>FRAME</i>	<i>SEAT PANEL</i>	<i>UPHOLSTERY</i>
AC31	MAFRO1	PN
<i>Black matt painted</i>	<i>Natural ash</i>	<i>Black leather</i>

h 640mm



FRAME  
AC31  
Black matt painted

SEAT PANEL  
MAFR09  
Graphite black stained

UPHOLSTERY  
CV134  
Canvas Kvadrat

FRAME

STEEL



AC30 White matt painted    AC31 Black matt painted    AC12 Black chrome plated    AC13 Copper plated

SEAT PANEL

POLYPROPYLENE



PP20 White    PP11 Anthracite    PP503 Powder blue    PP480C Cipria



PP7608U Marsala    PP27 Curry

SOLID ASH



MAFR01 Natural    MAFR09 Graphite black stained    MAFR10 Basalt grey stained

UPHOLSTERY AVAILABLE

FULL-GRAIN LEATHER

ECO LEATHER  
76% PVC, 2% PU, 22% PES

REVIVE 1 Kvadrat 100% PE FR ric.	FIELD Kvadrat 100% TREVIRA	HARALD Kvadrat 100% WO	FLASH No-Shrink 100% PP	STEELCUT 3 Kvadrat 90% WO, 10% PA	UMAMI Kvadrat 90% WO, 10% PA
CAVA 3 Kvadrat 90% WO, 10% PA	DIVINA 3 Kvadrat 100% WO	DIVINA MELANGE 2 Kvadrat 100% WO	GLOW Kvadrat 90% WO, 10% NY	PATINA Camira 69%WQ,22%FL,8%PO,1%VI	CANVAS Kvadrat 90% WO, 10% PA
RECHECK Kvadrat 90% WO, 10% NY	FIORD Kvadrat 92% WQ, 8% NY	BYTE 100% PL	DISCO COEX by Chioccarello 70% CO, 20% AC, 5% VI, 5% LI		

KLEJN  
KITCHEN STOOL UPHOLSTERED PANEL

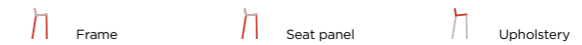



AC Matt painted steel	PP Polypropylene	Flash/Byte Eco Leather Patina Revive/Disco Coex Field Umami/Canvas/Steelcut/Recheck/Glow Divina3/DivinaMelange/Fiord/Harald Full Grain Leather COM fabric 0,70mt COM leather 1,00mq
--------------------------	---------------------	--

AC Coloured chromium-plated steel	PP Polypropylene	Flash/Byte Eco Leather Patina Revive/Disco Coex Field Umami/Canvas/Steelcut/Recheck/Glow Divina3/DivinaMelange/Fiord/Harald Full Grain Leather COM fabric 0,70mt COM leather 1,00mq
--------------------------------------	---------------------	--

1 PC  
5,5Kg / A= 37cm / B= 34cm / h= 67,5cm



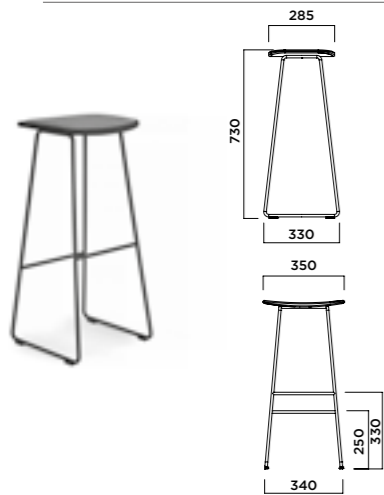

**KLEJN**  
 BAR STOOL UPHOLSTERED PANEL

 Frame
  Seat panel
  Upholstery



Frame	Seat panel	Upholstery
AC Matt painted steel	PP Polypropylene	Flash/Byte Eco Leather Patina Revive/Disco Coex Field Umami/Canvas/Steelcut/Recheck/Glow Divina3/DivinaMelange/Fjord/Harald Full Grain Leather COM fabric 0,50mt COM leather 0,20mq
AC Coloured chromium-plated steel	PP Polypropylene	Flash/Byte Eco Leather Patina Revive/Disco Coex Field Umami/Canvas/Steelcut/Recheck/Glow Divina3/DivinaMelange/Fjord/Harald Full Grain Leather COM fabric 0,50mt COM leather 0,20mq

 1 PC  
 6 Kg / A= 37cm / B= 34cm / h= 76,5cm





**KLEJN**  
 BAR STOOL WOOD  
 UPHOLSTERED PANEL

 Frame
  Seat panel
  Upholstery



Frame	Seat panel	Upholstery
AC Matt painted steel	MAFR Natural ash/whitened	Flash/Byte Eco Leather Patina Revive/Disco Coex Field Umami/Canvas/Steelcut/Recheck/Glow Divina3/DivinaMelange/Fjord/Harald Full Grain Leather COM fabric 0,50mt COM leather 0,20mq
AC Coloured chromium-plated steel	MAFR Stained ash	Flash/Byte Eco Leather Patina Revive/Disco Coex Field Umami/Canvas/Steelcut/Recheck/Glow Divina3/DivinaMelange/Fjord/Harald Full Grain Leather COM fabric 0,50mt COM leather 0,20mq
AC Matt painted steel	MAFR Natural ash/whitened	Flash/Byte Eco Leather Patina Revive/Disco Coex Field Umami/Canvas/Steelcut/Recheck/Glow Divina3/DivinaMelange/Fjord/Harald Full Grain Leather COM fabric 0,50mt COM leather 0,20mq
AC Coloured chromium-plated steel	MAFR Stained ash	Flash/Byte Eco Leather Patina Revive/Disco Coex Field Umami/Canvas/Steelcut/Recheck/Glow Divina3/DivinaMelange/Fjord/Harald Full Grain Leather COM fabric 0,50mt COM leather 0,20mq

 1 PC  
 6Kg / A= 34cm / B= 36cm / h= 66cm

**KLEJN**  
 KITCHEN STOOL WOOD  
 UPHOLSTERED PANEL

 Frame
  Seat panel
  Upholstery

Frame	Seat panel	Upholstery
AC Matt painted steel	MAFR Natural ash/whitened	Flash/Byte Eco Leather Patina Revive/Disco Coex Field Umami/Canvas/Steelcut/Recheck/Glow Divina3/DivinaMelange/Fjord/Harald Full Grain Leather COM fabric 0,50mt COM leather 0,20mq
AC Coloured chromium-plated steel	MAFR Stained ash	Flash/Byte Eco Leather Patina Revive/Disco Coex Field Umami/Canvas/Steelcut/Recheck/Glow Divina3/DivinaMelange/Fjord/Harald Full Grain Leather COM fabric 0,50mt COM leather 0,20mq
AC Matt painted steel	MAFR Natural ash/whitened	Flash/Byte Eco Leather Patina Revive/Disco Coex Field Umami/Canvas/Steelcut/Recheck/Glow Divina3/DivinaMelange/Fjord/Harald Full Grain Leather COM fabric 0,50mt COM leather 0,20mq
AC Coloured chromium-plated steel	MAFR Stained ash	Flash/Byte Eco Leather Patina Revive/Disco Coex Field Umami/Canvas/Steelcut/Recheck/Glow Divina3/DivinaMelange/Fjord/Harald Full Grain Leather COM fabric 0,50mt COM leather 0,20mq

 1 PC  
 5,5Kg / A= 37cm / B= 34cm / h= 67,5cm





FRAME  
AC31  
Black matt painted

SEAT PANEL  
MAFR09  
Graphite black stained

UPHOLSTERY  
CV134  
Canvas Kvadrat

# FLINK LOW

DESIGN:

**THOMAS PEDERSEN**

SWIVEL STOOL WITH STEEL STRUCTURE AND UPHOLSTERED SEAT PANEL, NOW AVAILABLE IN A BRAND NEW HEIGHT OF 45CM. THANKS TO THE DIFFERENT UPHOLSTERY FABRIC OPTIONS, FLINK IS THE RIGHT SOLUTION TO FURNISH BOTH COMMERCIAL AND BUSINESS ENVIRONMENTS.

**RANGE EXTENSION**





FRAME  
AC41  
Light grey  
fine textured

UPHOLSTERY  
GL873  
Glow Kvadrat

FRAME

STEEL



AC41  
Light grey fine  
textured



AC40  
Lead grey fine  
textured



AC44  
White fine textured



AC47  
Dove grey fine  
textured

UPHOLSTERY AVAILABLE

FULL-GRAIN LEATHER

REVIVE 1 Kvadrat  
100% PE FR ric.

CAVA 3 Kvadrat  
90% WO, 10% PA

RECHECK Kvadrat  
90% WO, 10% NY

ECO LEATHER  
76% PVC, 2% PU, 22% PES

FIELD Kvadrat  
100% TREVIRA

DIVINA 3 Kvadrat  
100% WO

FIORD Kvadrat  
92% WO, 8% NY

HARALD Kvadrat  
100% WO

DIVINA MELANGE 2 Kvadrat  
100% WO

BYTE  
100% PL

FLASH No-Shrink  
100% PP

GLOW Kvadrat  
90% WO, 10% NY

DISCO COEX by Chiocciello  
70% CO, 20% AC, 5% VI, 5% LI

STEELCUT 3 Kvadrat  
90% WO, 10% PA

PATINA Camira  
69% WO, 22% FL, 8% PO, 1% VI

UMAMI Kvadrat  
90% WO, 10% PA

CANVAS Kvadrat  
90% WO, 10% PA

FLINK LOW  
UPHOLSTERED



Frame



Upholstery

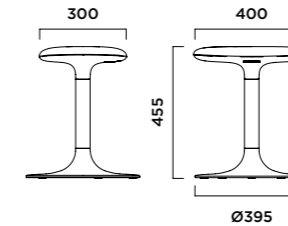

AC  
Painted steel

Flash/Byte  
Eco Leather  
Patina  
Revive/Disco Coex  
Field  
Umami/Canvas/Steelcut/Recheck/Glow  
Divina3/DivinaMelange/Fiord/Harald  
Full Grain Leather  
COM fabric 0,70mt  
COM leather 1,00mq

1PC  
8,3 Kg / A= 41,5cm / B= 43cm / h= 48cm





<b>FRAME</b>	<b>UPHOLSTERY</b>		
<b>AC40</b>	<b>GL443</b>	<b>GL723</b>	<b>GL873</b>
Lead grey	Glow Kvadrat	Glow Kvadrat	Glow Kvadrat
<i>fine textured</i>			

# RECORD BENCH

DESIGN:

**mC.dsg**

RECORD BENCH, CLEAN AND ESSENTIAL, IS NOW ALSO AVAILABLE WITH NATURAL OR BLACK WOODEN LEGS; THE RANGE OF SEAT PANELS EXPANDS WITH A NEW OVAL PANEL, A POST-CONSUMER PLASTIC FINISH AND A SOFT UPHOLSTERY FOR WOODEN BASES.

**NEW FINISHES**





<b>LEGS</b>				
STEEL	AC20 White embossed painted	AC03 Black embossed painted	HERITAGE OAK	RH03 Natural
				RH08 Black
<b>SEAT PANEL</b>				
RFS				
Recycled Fibreglass			RFS01	Edge 30mm
FENIX NTM*	FX01 White	FX02 Black	FX03 Anthracite	Edge 30mm
MATT WOOD		MW01 White	MW02 Black	Edge 25mm
HERITAGE OAK			RH03 Natural oak	RH08 Black
				Edge 30mm

**UPHOLSTERY AVAILABLE**

<b>FULL-GRAIN LEATHER</b>	<b>ECO LEATHER</b> 76% PVC, 2% PU, 22% PES				
REVIVE 1 Kvadrat 100% PE FR ric.	FIELD Kvadrat 100% TREVIRA	HARALD Kvadrat 100% WO	FLASH No-Shrink 100% PP	STEELCUT 3 Kvadrat 90% WO, 10% PA	UMAMI Kvadrat 90% WO, 10% PA
CAVA 3 Kvadrat 90% WO, 10% PA	DIVINA 3 Kvadrat 100% WO	DIVINA MELANGE 2 Kvadrat 100% WO	GLOW Kvadrat 90% WO, 10% NY	PATINA Camira 69% WO, 22% FL, 8% PQ, 1% VI	CANVAS Kvadrat 90% WO, 10% PA
RECHECK Kvadrat 90% WO, 10% NY	FIORD Kvadrat 92% WO, 8% NY	BYTE 100% PL	DISCO COEX by Chioccarello 70% CO, 20% AC, 5% VI, 5% LI		

**RECORD BENCH**

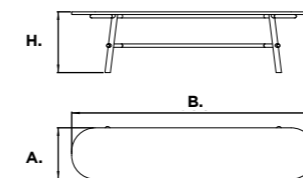

Dimensions	Legs	Seat
<b>H.</b> Height 450mm	AC Steel	RFS Recycled Fibreglass FX FENIX* MW Matt Wood RH Heritage Oak
<b>AxB.</b> Top 380x1800mm	RH Heritage Oak	FX FENIX* MW Matt Wood RH Heritage Oak
<b>H.</b> Height 450mm	AC Steel	RFS Recycled Fibreglass FX FENIX* MW Matt Wood RH Heritage Oak
<b>AxB.</b> Top 380x2200mm	RH Heritage Oak	FX FENIX* MW Matt Wood RH Heritage Oak

1 PC  
22,6 Kg / A= 182cm / B= 42cm / h= 48cm

**RECORD BENCH**  
UPHOLSTERED PANEL

Dimensions

 Legs

 Seat

 Upholstery

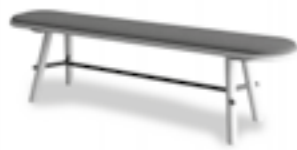

H.  
Height  
450mm

AxB.  
Top  
380x1800mm

			Flash/Byte Eco Leather Patina Revive/Disco Coex Field Umami/Canvas/Steelcut/Rechedy/Glow Divina3/DivinaMelange/Fjord/Harald Full Grain Leather COM fabric 0,70mt COM leather 1,00mq
AC Matt painted steel	MW Matt Wood		
	RH Heritage Oak		
RH Heritage Oak	MW Matt Wood		
	RH Heritage Oak		
	RH Heritage Oak		
STEEL FRAME	MATT WOOD TOP	23 Kg / A= 182cm / B= 42cm / h= 48cm	
	OAK TOP	21 Kg / A= 182cm / B= 42cm / h= 48cm	
WOODEN FRAME	MATT WOOD TOP	20 Kg / A= 182cm / B= 42cm / h= 48cm	
	OAK TOP	18 Kg / A= 182cm / B= 42cm / h= 48cm	

 380X1800

**RECORD BENCH**  
UPHOLSTERED PANEL

Dimensions

 Legs

 Seat

 Upholstery



H.  
Height  
450mm

AxB.  
Top  
380x2200mm

			Flash/Byte Eco Leather Patina Revive/Disco Coex Field Umami/Canvas/Steelcut/Rechedy/Glow Divina3/DivinaMelange/Fjord/Harald Full Grain Leather COM fabric 0,70mt COM leather 1,00mq
AC Matt painted steel	MW Matt Wood		
	RH Heritage Oak		
RH Heritage Oak	MW Matt Wood		
	RH Heritage Oak		
	RH Heritage Oak		
STEEL FRAME	MATT WOOD TOP	27 Kg / A= 182cm / B= 42cm / h= 48cm	
	OAK TOP	25 Kg / A= 182cm / B= 42cm / h= 48cm	
WOODEN FRAME	MATT WOOD TOP	24 Kg / A= 182cm / B= 42cm / h= 48cm	
	OAK TOP	22Kg / A= 182cm / B= 42cm / h= 48cm	

 380X2200



## RECORD BENCH

LEGS	SEAT	UPHOLSTERED PANEL
RH03	RH03	PT14
Natural oak	Natural oak	Patina

## RECORD LIVING TABLE OVAL

LEGS	TABLE TOP	FRAME FINISHES
RH03	RH03	ACO3
Natural oak	Natural oak	Embossed black painted



## RECORD LIVING

DESIGN:

**mC.dsg**

RECORD LIVING IS THE INNOVATIVE DESIGN TABLE THAT COMBINES STYLE AND VERSATILITY THROUGH THE INTERSECTION OF SIMPLE ESSENTIAL LINES. THE PRACTICAL INTERLOCKING LEG, WITH POINTED ENDS, GIVES THIS TABLE A SUGGESTIVE AND ELEGANT TOUCH. NOW THE TABLE TOP IS NOW AVAILABLE WITH A NEW OVAL SIZE. THE RECORD LIVING FAMILY ENRICHES ITS RANGE WITH A NEW VERSION: A STEEL STRUCTURE AND A POST-CONSUMER PLASTIC TOP THAT MAKE THE TABLE IDEAL FOR OUTDOOR USE.

**NEW FINISHES**





LEGS AND FRAME  
AC03  
Embossed black  
painted

TABLE TOP  
RFS01  
Recycled Fibreglass

<b>LEGS</b>				
STEEL			AC20 Embossed white painted	AC03 Embossed black painted
<b>FRAME FINISHES</b>				
STEEL			AC03 Embossed black painted	AC20 White embossed painted
<b>TABLE TOP</b>				
RFS			RFS01	Edge 30mm
Recycled Fibreglass				
<b>FENIX NTM®</b>				
	FX01 White	FX02 Black	FX03 Anthracite	Edge 30mm
<b>MATT WOOD</b>				
		MW01 White	MW02 Black	Edge 25mm
<b>HERITAGE OAK</b>				
		RH03 Natural oak	RH08 Black	Edge 30mm

**RECORD LIVING OUTDOOR - OVAL**

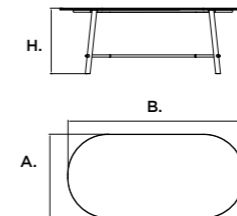

H.  
Height  
740mm

AxB.  
Top  
1000x1900mm  
1000x2200mm

1000X1900	WHEIGHT	A x B x h
KIT OF STEEL LEGS	10kg	76X23X10
CROSS BAR	14kg	168X81X14
TABLETOP - PCR	41kg	193,5X103X6

1000X2200	WHEIGHT	A x B x h
KIT OF STEEL LEGS	12kg	76X23X10
CROSS BAR	15kg	181X81X10
TABLETOP - PCR	45kg	223,5X103X6

## RECORD LIVING - OVAL

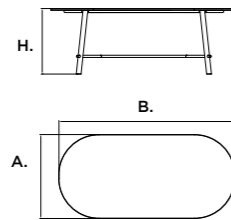

H.  
Height  
740mm

AxB.  
Top  
1000x1900mm  
1000x2200mm

## 1000X1900

WHEIGHT  A x B x h

KIT OF WOODEN LEGS	6kg	76X23X10
KIT OF STEEL LEGS	12kg	76X23X10
CROSS BAR	14kg	168X81X14
TABLETOP - FENIX	26kg	193,5X103X6
TABLETOP - MATT WOOD	26kg	193,5X103X6
TABLETOP - OAK	26kg	193,5X103X6

## 1000X2200

WHEIGHT  A x B x h

KIT OF STEEL LEGS	12kg	76X23X10
CROSS BAR	15kg	181X81X10
TABLETOP - FENIX	30kg	223,5X103X6
TABLETOP - MATT WOOD	30kg	223,5X103X6
TABLETOP - OAK	30kg	223,5X103X6

## RECORD LIVING - 4LEGS SQUARE

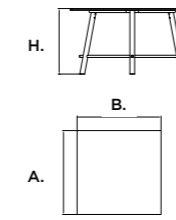

H.  
Height  
740mm

AxB.  
Top  
1000x1000mm  
1400x1400mm

## 1000X1000

WHEIGHT  A x B x h

KIT OF STEEL LEGS	12kg	76X23X10
CROSS BAR	12kg	93X91X140
TABLETOP - FENIX	15kg	113,5X113X6
TABLETOP - MATT WOOD	15kg	113,5X113X6
TABLETOP - OAK	15kg	113,5X113X6

## 1400X1400

WHEIGHT  A x B x h

KIT OF STEEL LEGS	12kg	76X23X10
CROSS BAR	12kg	115X100X14
TABLETOP - FENIX	29kg	143,5X143X6
TABLETOP - MATT WOOD	29kg	143,5X143X6
TABLETOP - OAK	29kg	143,5X143X6

## RECORD LIVING - 4 LEGS MAXI

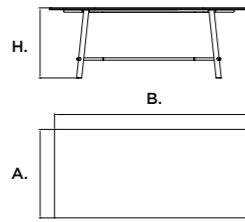

H.  
Height  
740mm

AxB.  
Top  
900x1600mm  
1000x1900mm  
1000x2200mm  
1000x2600mm

## RECORD LIVING - 3 LEGS ROUND



H.  
Height  
740mm

A.  
Top  
Ø 1100mm  
Ø 1400mm

## 900X1000

WHEIGHT  A x B x h

KIT OF STEEL LEGS	12kg	76X23X10
CROSS BAR	12kg	138X71X14
TABLETOP - FENIX	23kg	163,5X93X6
TABLETOP - MATT WOOD	23kg	163,5X93X6
TABLETOP - OAK	23kg	163,5X93X6

## 1000X1900

WHEIGHT  A x B x h

KIT OF STEEL LEGS	12kg	76X23X10
CROSS BAR	14kg	168X81X14
TABLETOP - FENIX	28kg	193,5X103X6
TABLETOP - MATT WOOD	28kg	193,5X103X6
TABLETOP - OAK	28kg	193,5X103X6

## 1000X2600

WHEIGHT  A x B x h

KIT OF STEEL LEGS	12kg	76X23X10
CROSS BAR	15kg	211X81X14
TABLETOP - FENIX	32kg	263,5X103X6
TABLETOP - MATT WOOD	32kg	263,5X103X6
TABLETOP - OAK	32kg	263,5X103X6

## 1400X1400

WHEIGHT  A x B x h

KIT OF STEEL LEGS	12kg	76X23X10
CROSS BAR	15kg	211X81X14
TABLETOP - FENIX	38kg	223,5X103X6
TABLETOP - MATT WOOD	38kg	223,5X103X6
TABLETOP - OAK	38kg	223,5X103X6

## Ø 1100

WHEIGHT  A x B x h

KIT OF STEEL LEGS	9kg	76X23X7
CROSS BAR	6kg	91X88X10
TABLETOP - FENIX	17kg	113,5X113X6
TABLETOP - MATT WOOD	17kg	113,5X113X6
TABLETOP - OAK	17kg	113,5X113X6

## Ø 1400

WHEIGHT  A x B x h

KIT OF STEEL LEGS	9kg	76X23X10
CROSS BAR	7kg	115X110X14
TABLETOP - FENIX	26kg	138,5X38X6
TABLETOP - MATT WOOD	26kg	138,5X38X6
TABLETOP - OAK	26kg	138,5X38X6



LEGS AND FRAME  
AC03  
Embossed black  
painted

TOP  
RFS01  
Recycled Fibreglass

# RECORD MEETING

DESIGN:

**mC.dsg** | THE ULTIMATE EVOLUTION OF THE RECORD FAMILY, AVAILABLE NOW WITH A NARROWER RECTANGULAR DIMENSION.



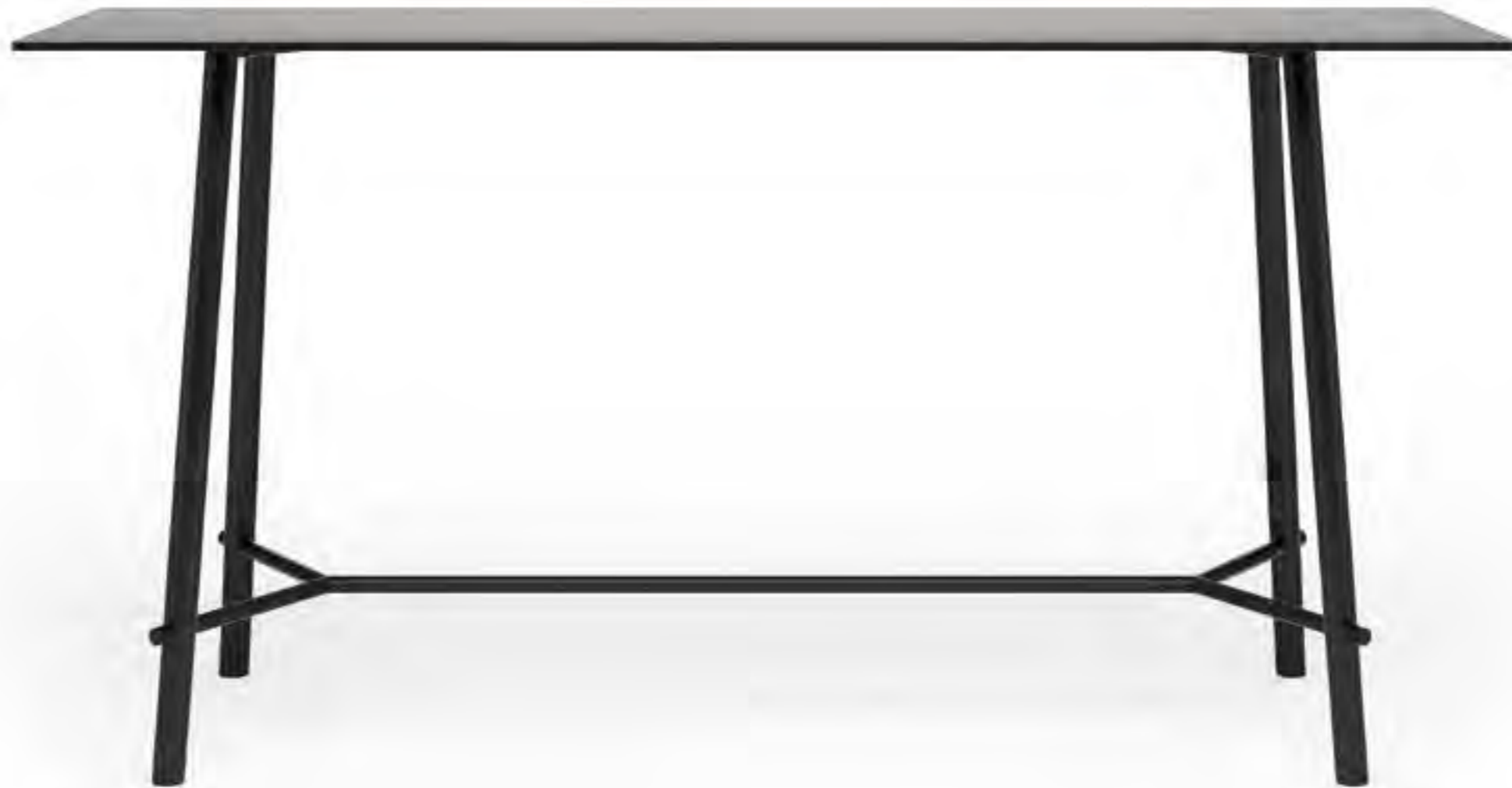







**NEW FINISHES**





LEGS/FRAME  
AC03  
Embossed black  
painted

TABLE TOP  
FX02  
Black

<b>LEGS/FRAME</b>			
STEEL	AC20 Embossed white painted	AC03 Embossed black painted	
<b>TABLE TOP</b>			
LAMINATES	LM01 White	LM02 Black	Edge 30mm
<b>FENIX NTM®</b>			
	FX01 White	FX02 Black	Edge 10mm
<b>HERITAGE OAK</b>			
	RH03 Natural	RH08 Black	Edge 30mm

**RECORD MEETING**

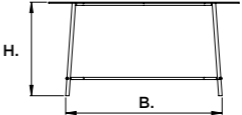
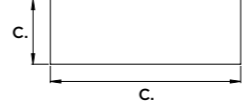
		<b>H.</b> Height 1070mm	<b>B.</b> Base 1808x677mm	<b>C.</b> Top 750x1900mm 750x2200mm
				

750X1900	WHEIGHT	A x B x h
KIT OF STEEL LEGS	18kg	177X58,5X14
TABLETOP - LAMINATE/OAK	26kg	195,5X81X8
TABLETOP - FENIX	12kg	195,5X81X8

750X2200	WHEIGHT	A x B x h
KIT OF STEEL LEGS	18kg	177X58,5X14
TABLETOP - LAMINATE/OAK	30kg	225,5X81X8
TABLETOP - FENIX	13,8kg	225,5X81X8

**RECORD MEETING**

LEGS/FRAME

AC03  
Embossed black painted

TABLE TOP

FX02  
White**RECORD LIVING TABLE OVAL**

FRAME

AC31  
Black matt paintedAC12  
Black chrome plated**KLEJN BAR STOOL**

FRAME

PP11  
Anthracite

SEAT PANEL

MAFR03  
Whitened ash



**INFINITI**

Via Ca' Leoncino, 2 - 31030  
Castello di Godego (TV) - ITALY

ph +39 0423 7616

[www.infinitidesign.it](http://www.infinitidesign.it)

Concept and Design  
**TAILOR&TAILOR**  
*thetailors.it*

Photo  
**STUDIO B2 - ORLANDO BONALDO**

3D Images  
**BRUGER STUDIO**  
*brugerstudio.com*

-  
**IMAGINE CG**  
*imaginecg.it*

Colour separation and Print  
**KAPPADUE**  
*kappadue.net*

