

---

# BuzziFalls

## Product Specification Sheet

---

Discover all insights on BuzziFalls.  
Acoustical room dividers offering you a  
variety of patterns, sizes and colors to  
organize your space.

---



[www.buzzi.space](http://www.buzzi.space)







## A playful solution to regulate sounds

To divide a space and create some privacy, the BuzziFalls are a new playful variation in our acoustic solutions gamma. These strips are made out of BuzziFelt with cut-out shapes in various patterns, for example falling leaves. A playful solution to regulate sounds and create smaller areas in big spaces.

Design by Sas Adriaenssens

---

## General

-  Pattern: Alhambra, Birch, Cubes, Dots, Grid, Leaves, Orient, Palms, Parrots, Pebbles, Plain, Rain, Squares, Stars, Royal, Tropics
-  2 layers of BuzziFelt
-  Profile metal powdercoated black | RAL 9005 matte or metal powdercoated White | RAL 9010 matte  
Pendant black steel cable for black profile | alu steel cable for white profile
-  Pattern: W 80 cm H 220 or 250 cm D 1 cm  
W 31.50" H 86.61 or 98.42" D 0.40"
-  BuzziFall Wall | Ceiling mounted or BuzziFall Suspended  
Cable L 2 or 5 m, Ø 1,5 mm  
L 78.74 or 196.85", Ø 0.06"
-  Possibility to connect several BuzziFalls  
Rail (1 | 2 | 3 falls in 1 rail)  
Extra rail for extension  
Bicolor

---

## Acoustics



Absorption



Diffusion



Attenuation



High tone

---

## Certifications



---

## Content

Fabrics	3	Option Rail	10
Patterns	4	Dimensions	11
Fixing systems	6	Acoustics	13

# Fabrics

---

## Felt\*

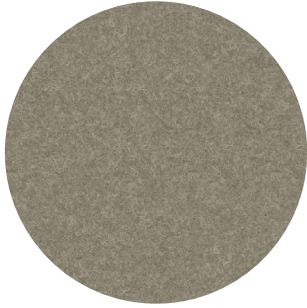

**Composition** 100% Recycled PE.T. Felt, latex backing  
**Weight** 1.000 g/m2 | 29.49 oz/yd2  
**Abrasion resistance** >7.000 Martindale  
**Flammability** EU: EN 13501.1 + A1/2009 Class B-s1,d0  
USA: ASTM E84 Class A certified  
**Fastness to light** USA 5



\* not available in EcoBrown 58

---

## Felt Printed\*\*



Concrete

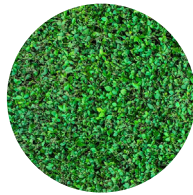

Green 1



Green 2



Jungle

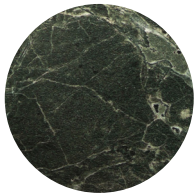

Marble Absynth

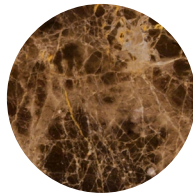

Marble Emperador



Camo Amazon



Camo Taiga



Camo Desert



Camo Snow

\*\*Technical Specification same as Felt

---

# Patterns

## Alhambra

250 cm 98.42"  
3,1 kg 6.83 lbs

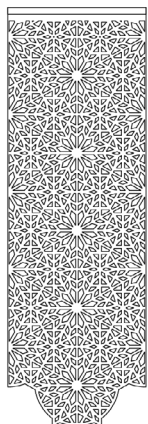

## Birch

220 cm 86.61"  
2,8 kg 6.17 lbs



## Birch

250 cm 98.42"  
2,6 kg 5.70 lbs

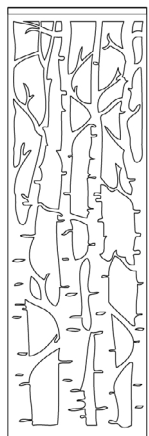

## Cubes

220 cm 86.61"  
2,5 kg 5.51 lbs



## Cubes

250 cm 98.42"  
3,9 kg 8.71 lbs

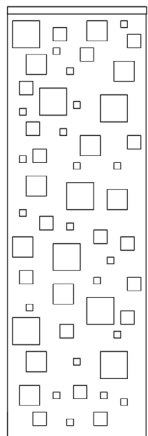

220 cm 86.61"  
3,4 kg 7.56 lbs

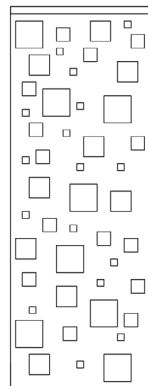

## Dots

250 cm 98.42"  
4,6 kg 10.14 lbs

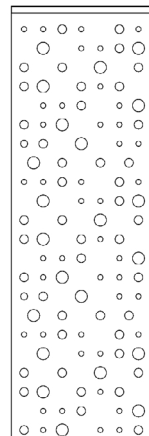

220 cm 86.61"  
4 kg 8.82 lbs

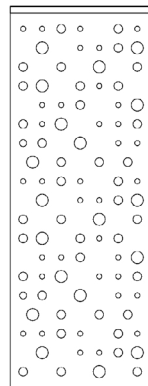

## Grid

250 cm 98.42"  
3 kg 6.61 lbs

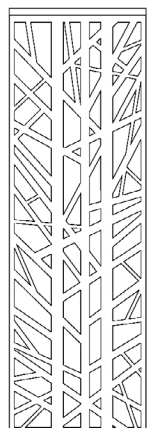

220 cm 86.61"  
2,6 kg 5.73 lbs

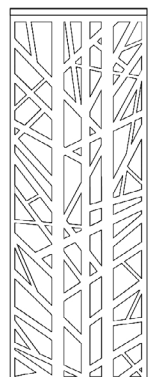

## Leaves

250 cm 98.42"  
3,1 kg 6.83 lbs



220 cm 86.61"  
2,8 kg 6.17 lbs



## Orient

250 cm 98.42"  
3,7 kg 8.16 lbs

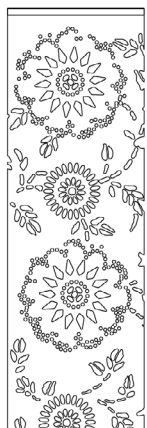

220 cm 86.61"  
3,3 kg 7.27 lbs



## Palms

250 cm 98.42"  
4,3 kg 9.48 lbs

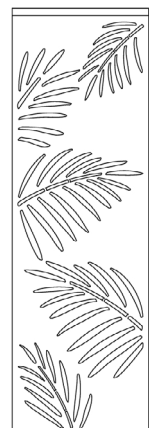

220 cm 86.61"  
3,8 kg 8.38 lbs

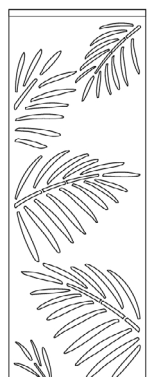

**Parrots**

**250 cm 98.42"** **220 cm 86.61"**  
**3,6 kg 7.94 lbs** **3,2 kg 7.05 lbs**



**Pebbles**

**250 cm 98.42"** **220 cm 86.61"**  
**2 kg 4.41 lbs** **1.8 kg 3.97 lbs**

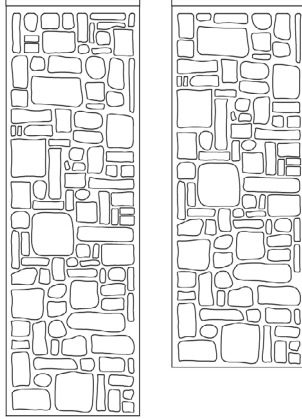

**Plain**

**250 cm 98.42"** **220 cm 86.61"**  
**5,2 kg 11.46 lbs** **4,5 kg 9.92 lbs**

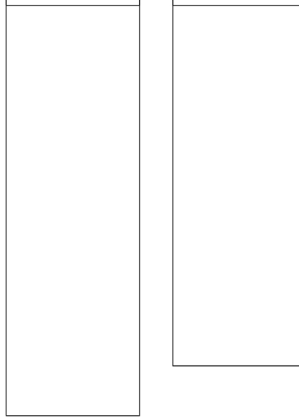

**Rain**

**250 cm 98.42"** **220 cm 86.61"**  
**3,9 kg 8.60 lbs** **3,4 kg 7.50 lbs**

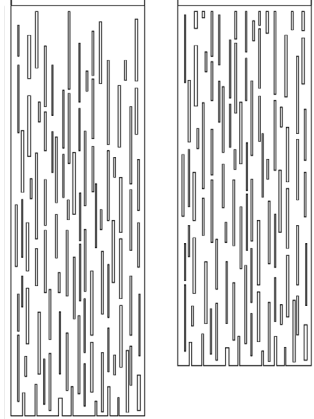

**Royal**

**250 cm 98.42"** **220 cm 86.61"**  
**3,6 kg 8.00 lbs** **3,2 kg 7.05 lbs**

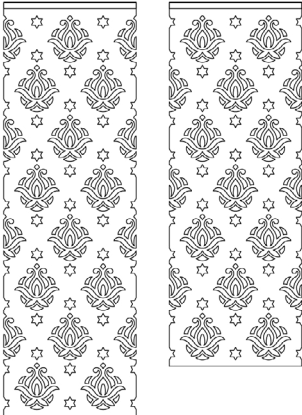

**Squares**

**250 cm 98.42"** **220 cm 86.61"**  
**4,3 kg 9.41 lbs** **3,8 kg 8.33 lbs**

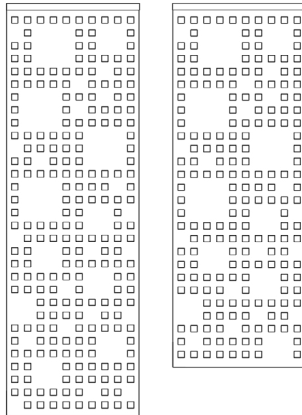

**Stars**

**250 cm 98.42"** **220 cm 86.61"**  
**4,9 kg 10.87 lbs** **4,3 kg 9.57 lbs**

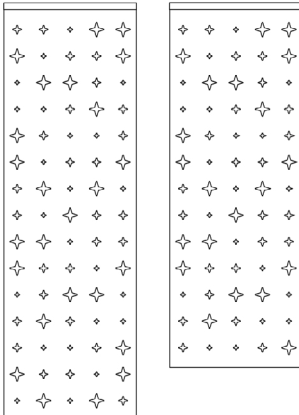

**Tropics**

**250 cm 98.42"** **220 cm 86.61"**  
**3,1 kg 6.83 lbs** **2,7 kg 5.95 lbs**

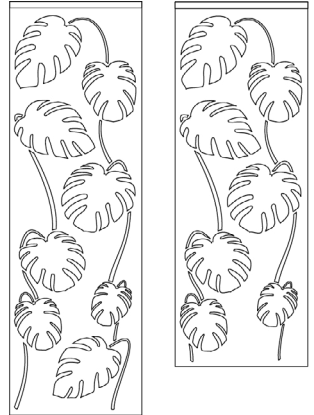



# Fixing Systems

## BuzziFalls Suspended

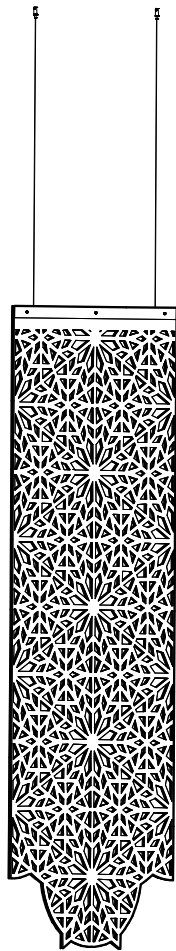

## BuzziFalls Suspended > 1

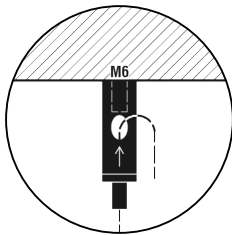
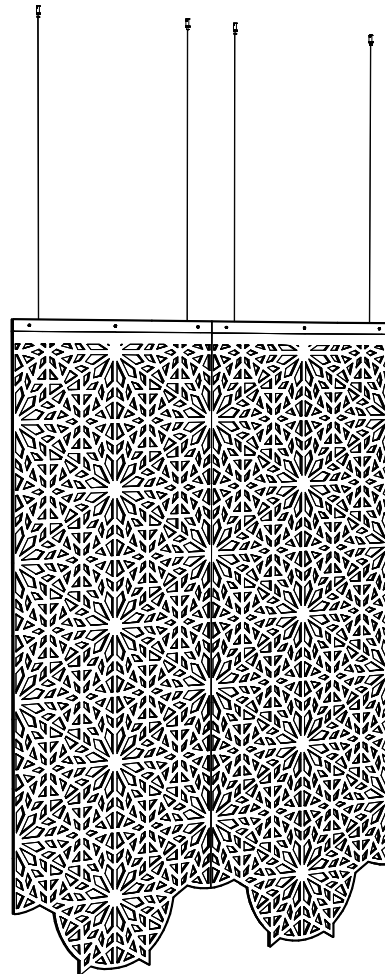

Profile black or white

2 cables per set, incl. fastner  
(stair bolts M6)

Black or alu colored cable  
L 200 or 500 cm, Ø 1,5 mm  
L 78.74" or 196.85", Ø 0.06"

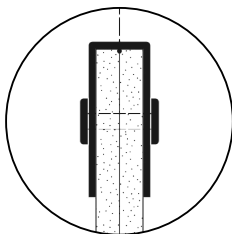

---

## BuzziFalls Ceiling Mounted

---

## BuzziFalls Ceiling Mounted > 1

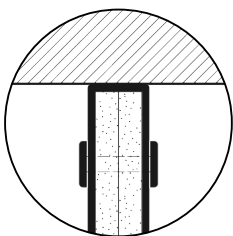
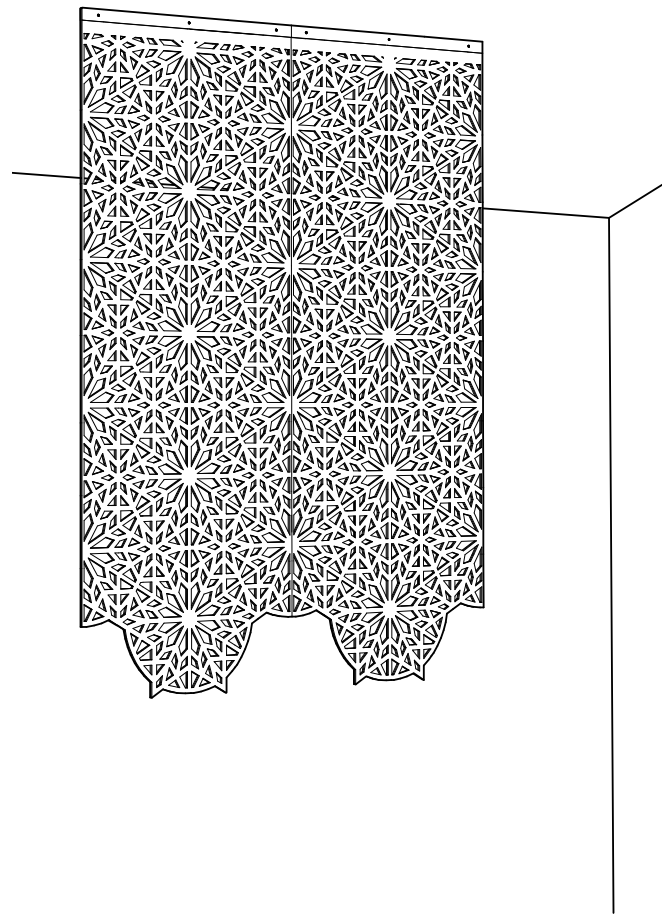
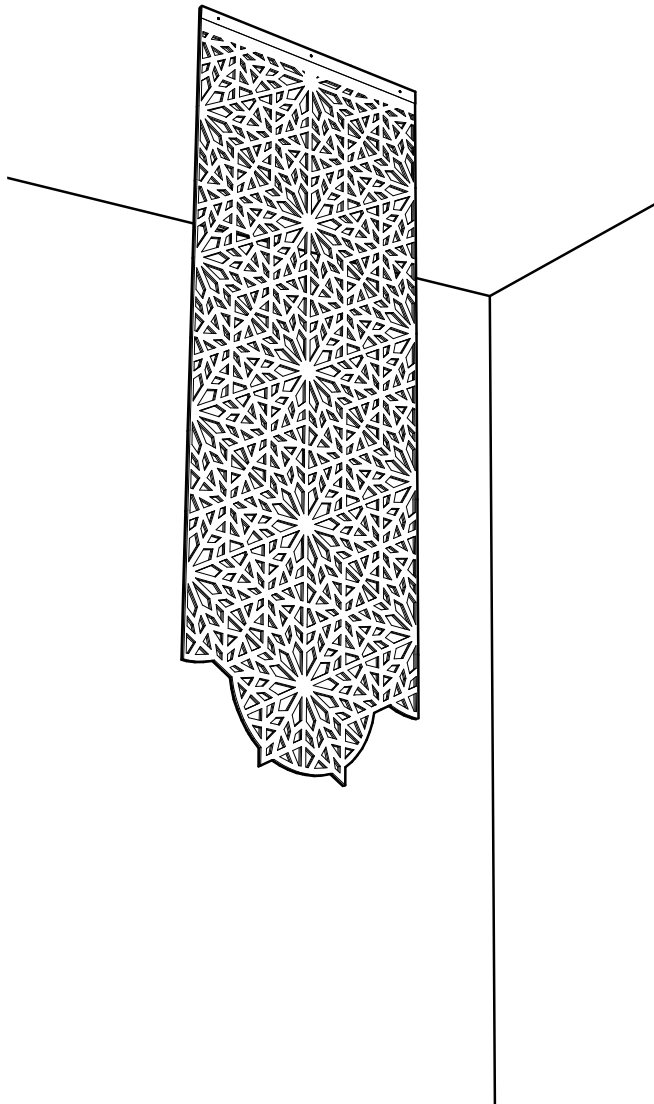

Profile black or white

---

## BuzziFalls Wall Mounted

---

## BuzziFalls Wall Mounted >1

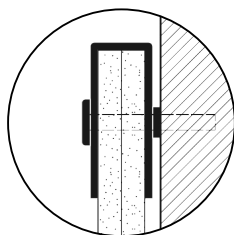
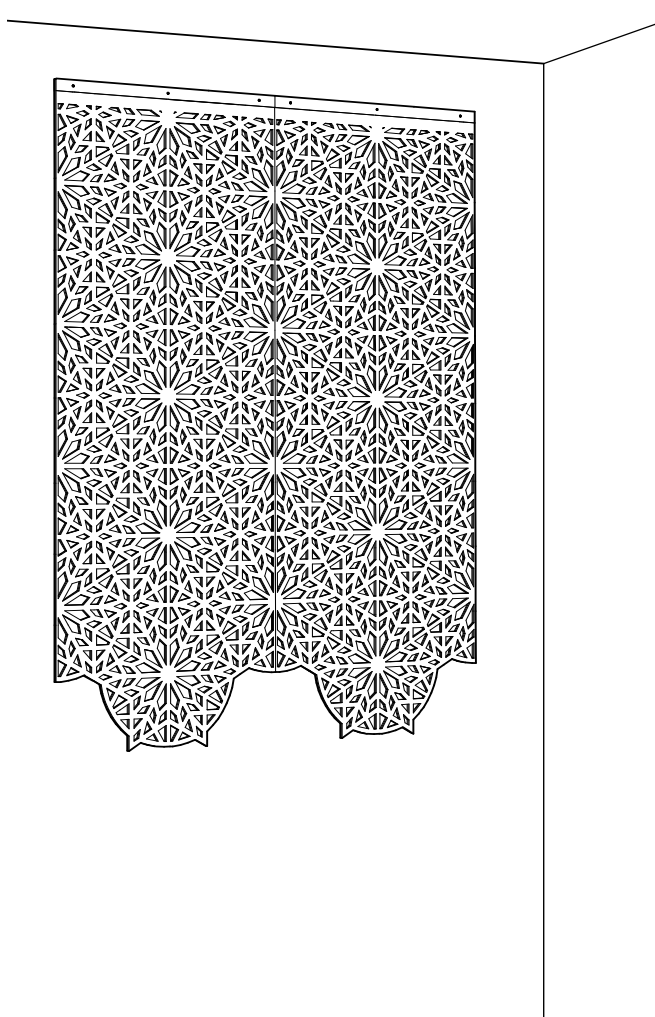
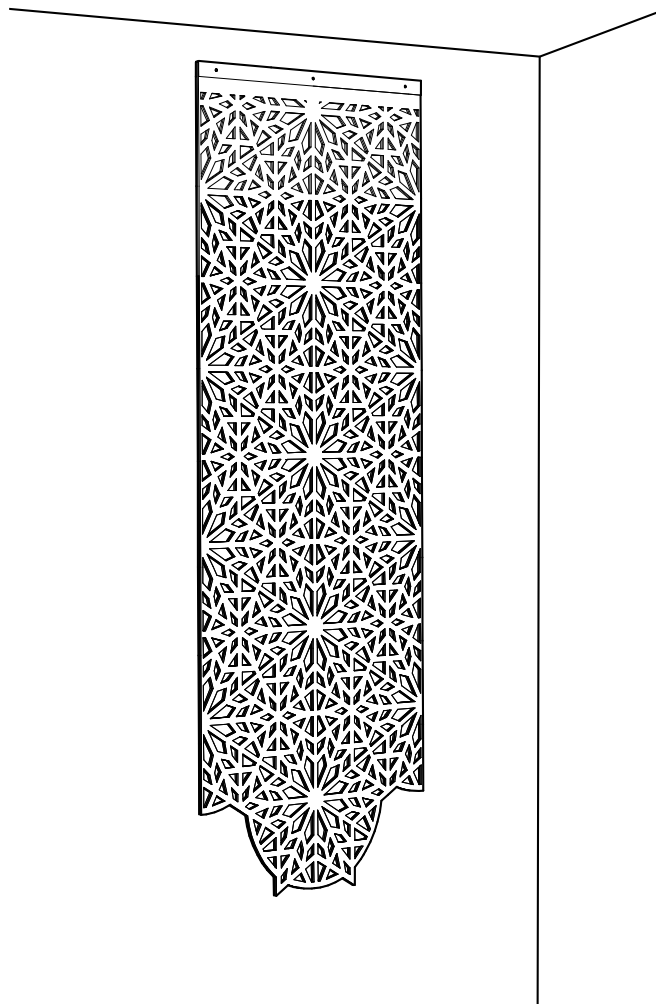

Profile black or white

3 screws 4x60 mm per set

3 cover caps per set, black or white, depending on color of profile

6 distance holders: 3 x 3 mm and 3 x 7,5 mm per set



---

## BuzziFalls Rail Suspended

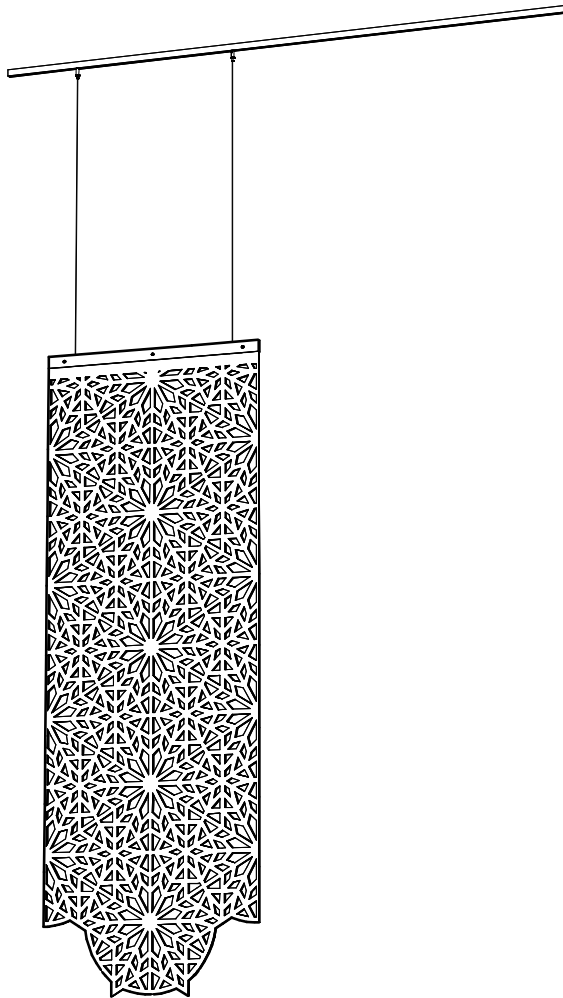

---

## BuzziFalls Rail Mounted

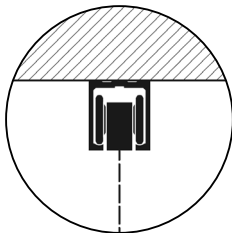
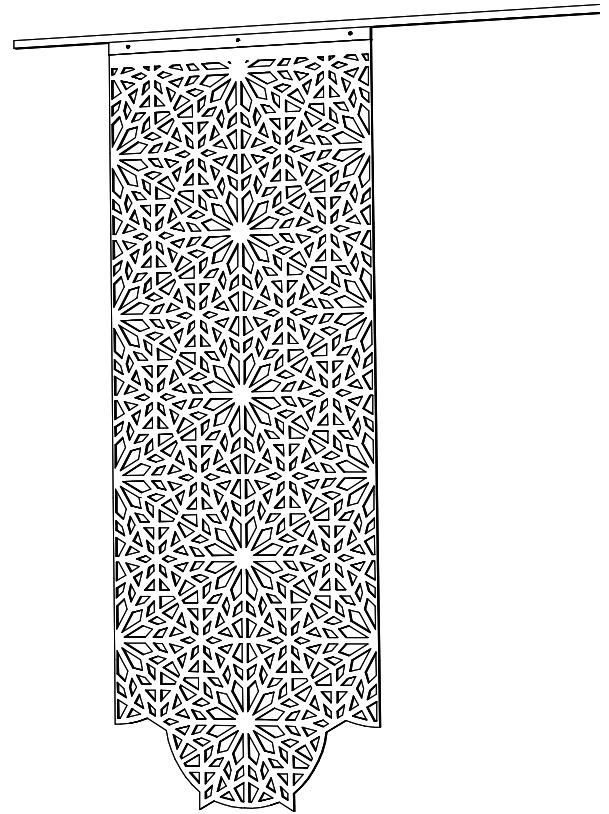

Rail black or white  
L: 3,20 m | 125.98"

Profile black or white

Black or alu colored cable  
L 200 or 500 cm,  
Ø 1,5 mm  
L 78.74" or 196.85",  
Ø 0.06"

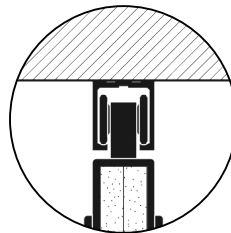
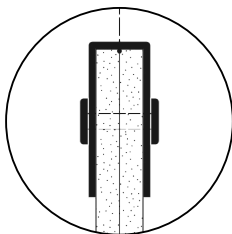

Rail black or white  
L 3,20 m | 125.98"

Profile black or white

# Option: Rail

The rail can be extended by buying a extra rail

---

## BuzziFalls Rail Suspended

Profile black or white

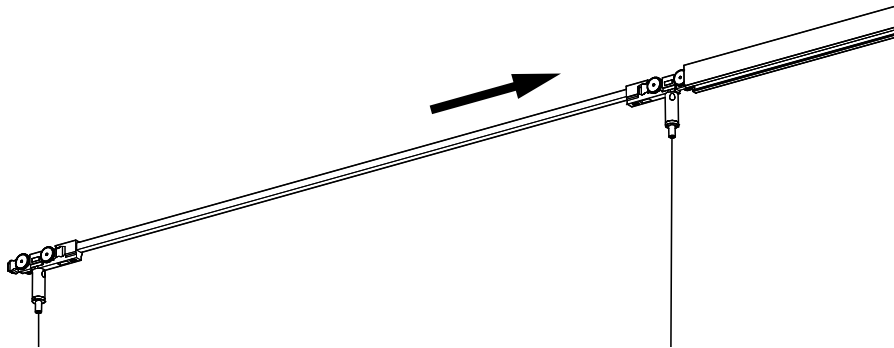

---

## BuzziFalls Rail Mounted

Profile black or white

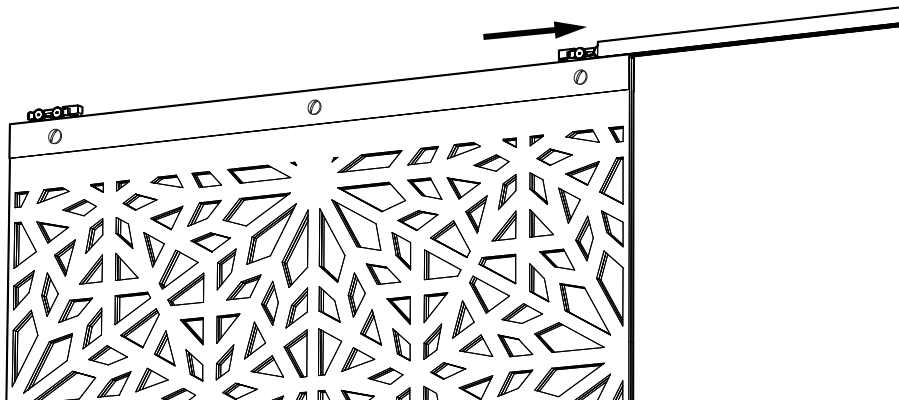

---

## Rail

Black or white, L 3,20 m | 125.98".

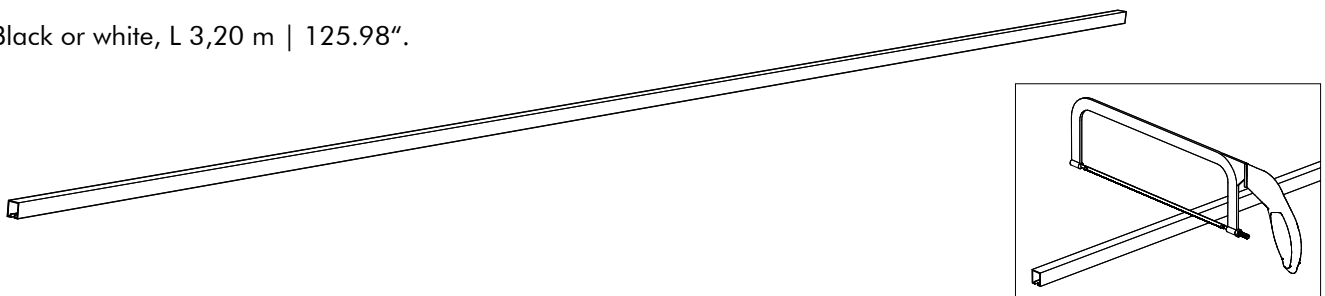

---

## End cap

End cap black or white included

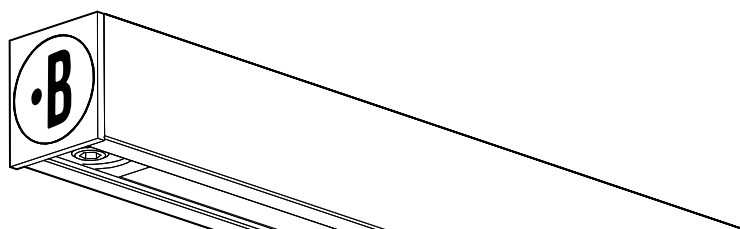

# Dimensions

## Falls Felt

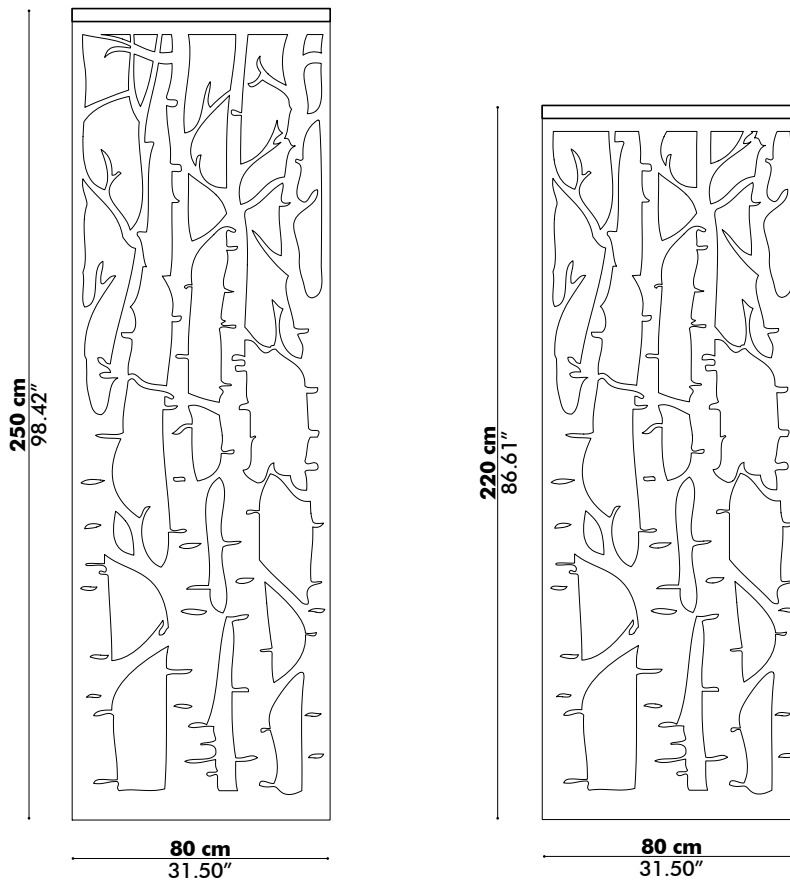

## Metal Profile

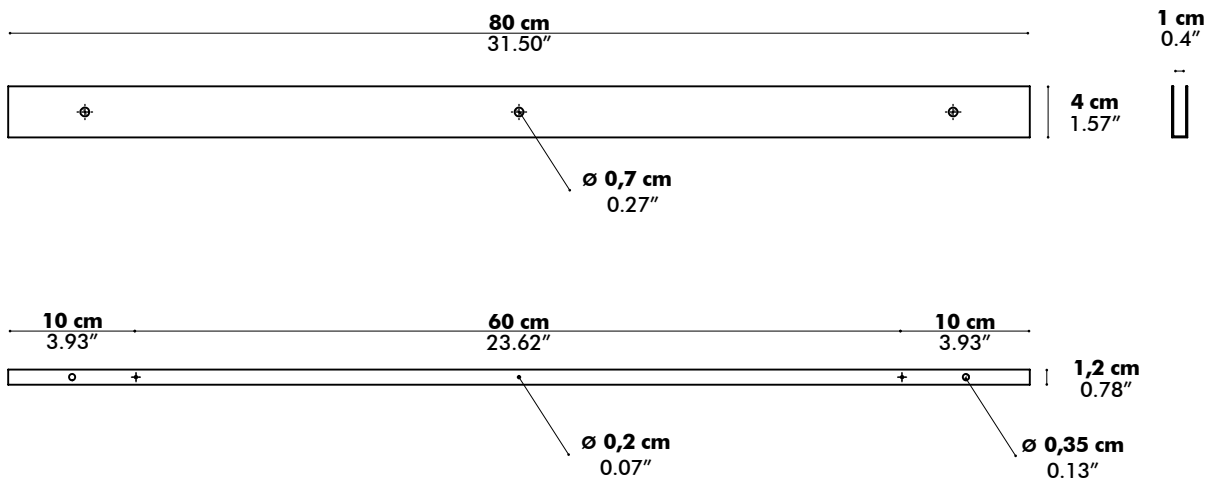

500 gr | 1.10 lbs

# Alu Rail

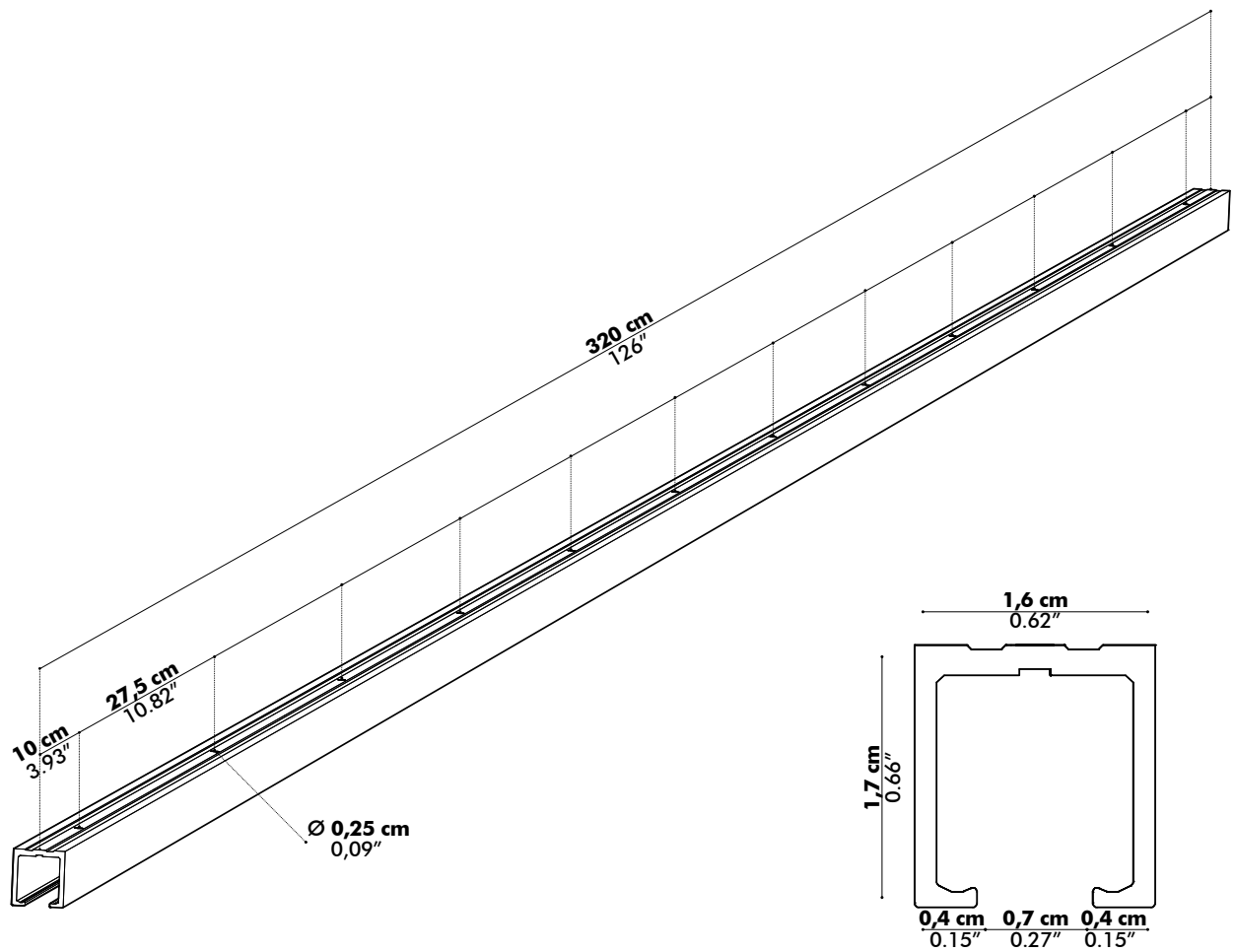

# Acoustics

## BuzziFalls Alhambra | Birch | Plain

Equivalent sound absorption area in m<sup>2</sup> per object

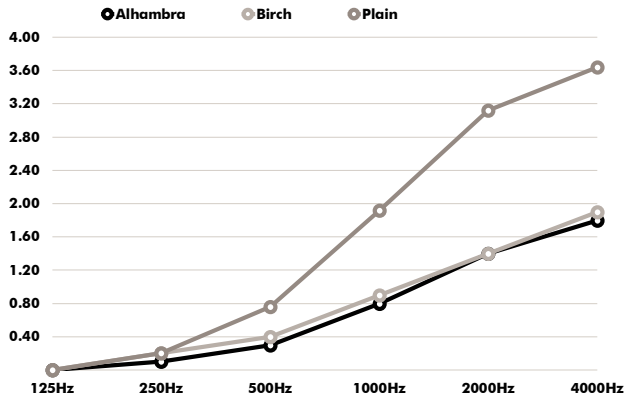

Hz	Alhambra Aeq/m <sup>2</sup>	Birch Aeq/m <sup>2</sup>	Plain Aeq/m <sup>2</sup>
125	0.00	0.00	0.04
250	0.10	0.20	0.20
500	0.30	0.40	0.76
1000	0.80	0.90	1.92
2000	1.40	1.40	3.12
4000	1.80	1.90	3.64